

FRANCHISE DISCLOSURE DOCUMENT

ZENSHI

Advanced Fresh Concepts Franchise Corp.

a California corporation
19700 Mariner Avenue
Torrance, California 90503
Telephone: 310-604-3200
info@afcsushi.com
www.afcsushi.com



Advanced Fresh Concepts Franchise Corp. (“AFC”) will grant you a franchise to use our system to offer prepared sushi and other Asian style foods from one or more (i) Zenshi Counters at a grocery store, retail center or other location that someone else owns (“Zenshi Counter”); (ii) AFC food service counters at a grocery store, retail center or other location that someone else owns (“AFC Food Service Counter”); (iii) Wild Blue Counters at a university or other select locations (“Wild Blue Counter”).

The total investment necessary to begin operation of a Zenshi Counter/AFC Food Service Counter/Wild Blue Counter is as follows: (1) if you are a new franchisee, the estimated total investment for one full-time or part-time Zenshi Counter/AFC Food Service Counter/Wild Blue Counter is between \$45,004 and \$151,404 for a non-AFC operated location and between \$46,004 and \$251,404 if you purchase an existing AFC operated location. This includes \$42,244 to \$237,074 that must be paid to us; (2) if you are an existing franchisee purchasing an additional full-time or part-time Zenshi Counter/AFC Food Service Counter/Wild Blue Counter, the estimated total investment necessary to begin operation of each additional Zenshi Counter/AFC Food Service Counter/Wild Blue Counter is between \$42,019 and \$130,324 for a non-AFC operated location and \$43,019 and \$230,324 for an existing AFC operated location. This includes \$40,769 to \$227,524 that must be paid to us; (3) if you are an existing franchisee purchasing a self-service Zenshi Counter/AFC Food Service Counter/Wild Blue Counter, the estimated total investment necessary to begin operations is between \$4,025 and \$20,900. This includes \$4,025 to \$20,000 that must be paid to us.

This disclosure document summarizes certain provisions of your franchise agreement and other information in plain English. Read this disclosure document and all accompanying agreements carefully. You must receive this disclosure document at least 14 calendar days before you sign a binding agreement with, or make any payment to, the franchisor or an affiliate in connection with the proposed franchise sale. **Note, however, that no governmental agency has verified the information contained in this document.**

You may wish to receive your disclosure document in another format that is more convenient for you. To discuss the availability of disclosures in different formats, contact Vincenzo Calcagni, at 19700 Mariner Avenue, Torrance, California 90503, Telephone: 310-604-3200.

The terms of your contract will govern your franchise relationship. Don’t rely on the disclosure document alone to understand your contract. Read all of your contract carefully. Show your contract and this disclosure document to an advisor, like a lawyer or an accountant.

Buying a franchise is a complex investment. The information in this disclosure document can help you make your mind. More information on franchising, such as “A Consumer Guide’s to Buying a Franchise,” which can help you understand how to use this disclosure document, is available from the Federal Trade Commission. You can contact the FTC at 1-877-FTC-HELP or by writing to the FTC at 600 Pennsylvania Avenue, NW, Washington, D.C. 20580. You can also visit the FTC’s home page at www.ftc.gov for additional information. Call your state agency or visit your public library for other sources of information on franchising.

There may also be laws on franchising in your state. Ask your state agencies about them.

FTC Issuance Date: July 22, 2025, amended August 28, 2025, September 23, 2025 and May 7, 2026

How to Use This Franchise Disclosure Document

Here are some questions you may be asking about buying a franchise and tips on how to find more information:

QUESTION	WHERE TO FIND INFORMATION
How much can I earn?	Item 19 may give you information about outlet sales, costs, profits or losses. You should also try to obtain this information from others, like current and former franchisees. You can find their names and contact information in Item 20 or Exhibit M.
How much will I need to invest?	Items 5 and 6 list fees you will be paying to the franchisor or at the franchisor's direction. Item 7 lists the initial investment to open. Item 8 describes the suppliers you must use.
Does the franchisor have the financial ability to provide support to my business?	Item 21 or Exhibit A includes financial statements. Review these statements carefully.
Is the franchise system stable, growing, or shrinking?	Item 20 summarizes the recent history of the number of company-owned and franchised outlets.
Will my business be the only AFC business in my area?	Item 12 and the "territory" provisions in the franchise agreement describe whether the franchisor and other franchisees can compete with you.
Does the franchisor have a troubled legal history?	Items 3 and 4 tell you whether the franchisor or its management have been involved in material litigation or bankruptcy proceedings.
What's it like to be a AFC franchisee?	Item 20 or Exhibit M lists current and former franchisees. You can contact them to ask about their experiences.
What else should I know?	These questions are only a few things you should look for. Review all 23 Items and all Exhibits in this disclosure document to better understand this franchise opportunity. See the table of contents.

What You Need To Know About Franchising *Generally*

Continuing responsibility to pay fees. You may have to pay royalties and other fees even if you are losing money.

Business model can change. The franchise agreement may allow the franchisor to change its manuals and business model without your consent. These changes may require you to make additional investments in your franchise business or may harm your franchise business.

Supplier restrictions. You may have to buy or lease items from the franchisor or a limited group of suppliers the franchisor designates. These items may be more expensive than similar items you could buy on your own.

Operating restrictions. The franchise agreement may prohibit you from operating a similar business during the term of the franchise. There are usually other restrictions. Some examples may include controlling your location, your access to customers, what you sell, how you market, and your hours of operation.

Competition from franchisor. Even if the franchise agreement grants you a territory, the franchisor may have the right to compete with you in your territory.

Renewal. Your franchise agreement may not permit you to renew. Even if it does, you may have to sign a new agreement with different terms and conditions in order to continue to operate your franchise business.

When your franchise ends. The franchise agreement may prohibit you from operating a similar business after your franchise ends even if you still have obligations to your landlord or other creditors.

Some States Require Registration

Your state may have a franchise law, or other law, that requires franchisors to register before offering or selling franchises in the state. Registration does not mean that the state recommends the franchise or has verified the information in this document. To find out if your state has a registration requirement, or to contact your state, use the agency information in Exhibit N.

Your state also may have laws that require special disclosures or amendments be made to your franchise agreement. If so, you should check the State Specific Addenda. See the Table of Contents for the location of the State Specific Addenda.

Special Risks to Consider About *This Franchise*

Certain states require that the following risk(s) be highlighted:

1. **Out-of-State Dispute Resolution.** The franchise agreement requires you to resolve disputes with the franchisor by arbitration only in California. Out-of-state arbitration may force you to accept a less favorable settlement for disputes. It may also cost more to arbitrate with the franchisor in California than in your own state.
2. **Turnover Rate.** During the last 3 years, a large number of franchised outlets were terminated, not renewed, re-acquired, or ceased operations for other reasons. This franchise could be a higher risk investment than a franchise in a system with a lower turnover rate.

Certain states may require other risks to be highlighted. Check the “State Specific Addenda” (if any) to see whether your state requires other risks to be highlighted.

TABLE OF CONTENTS

<u>ITEM</u>		<u>PAGE</u>
Item 1	The Franchisor and Any Parents, Predecessors and Affiliates	1
Item 2	Business Experience	5
Item 3	Litigation	7
Item 4	Bankruptcy	9
Item 5	Initial Fees	9
Item 6	Other Fees	10
Item 7	Estimated Initial Investment.....	16
Item 8	Restrictions on Sources of Products and Services.....	23
Item 9	Franchisee’s Obligations	25
Item 10	Financing	27
Item 11	Franchisor’s Assistance, Advertising, Computer Systems and Training.....	28
Item 12	Territory.....	33
Item 13	Trademarks	35
Item 14	Patents, Copyrights and Proprietary Information	38
Item 15	Obligation to Participate in the Actual Operation of the Franchise Business.....	39
Item 16	Restrictions on What the Franchisee May Sell.....	40
Item 17	Renewal, Termination, Transfer and Dispute Resolution.....	40
Item 18	Public Figures	49
Item 19	Financial Performance Representations	49
Item 20	Outlets and Franchisee Information.....	49
Item 21	Financial Statements.....	76
Item 22	Contracts.....	76
Item 23	Receipts	76

EXHIBITS

- A. Financial Statements
- B. Franchise Application
- C. Franchise Agreement
- D. Full-Time Location Franchise Addendum
- E. Part-Time Location Addendum
- F. Self-Service Location Addendum
- G. General Release
- H. Assignment of Franchise Agreement and Franchisor Consent
- I. Asset Sale and Purchase Agreement
- J. Food Service Counter Transfer Agreement
- K. Promissory Note
- L. Table of Contents of Operating Manual, SSOP Manual and Steam Table Manual
- M. List of Franchisees, Company Owned Locations, Transfers, Terminations, Non-Renewals, Ceased Operations/Other in Our Last Fiscal Year
- N. List of State Administrators and Agents for Service of Process
- O. State Specific Addenda
- P. Confidentiality Agreement
- Q. Tablet and Rice Sheeter Specifications
- R. RECEIPTS

ITEM 1 THE FRANCHISOR AND ANY PARENTS, PREDECESSORS AND AFFILIATES

We are Advanced Fresh Concepts Franchise Corp., a California corporation, incorporated on April 30, 2002. To simplify this Disclosure Document, we refer to ourselves as “AFC,” “Advanced Fresh Concepts,” “we” or “us.” We refer to Zenshi Counter(s), AFC Food Service Counter(s), and Wild Blue Counter(s) collectively as “Food Service Counter(s).” We refer to the person or company that buys a franchise from us as “you.”

Our immediate parent is Advanced Fresh Concepts Corp. (“AFCC”) which granted us a license to use certain trademarks and to grant the use of the trademarks to our franchisees. They were incorporated in California in 1986. We have no other predecessor. We are affiliated with, Advanced Fresh Concepts Pty. Ltd. (“AFCPL”), an Australian entity formed on April 23, 2015 and AFC Distribution Corp. dba Wonderfield Distribution (“AFCDC”), a California corporation incorporated on April 29, 2016.

The business address for us is 19700 Mariner Avenue, Torrance, California 90503, and the business address for AFCC and AFCDC is 19205 South Laurel Park Road, Rancho Dominguez, California 90220. Our phone number is 310-604-3200. Our agent for service of process in California is Incorp Services, Inc. 5716 Corsa Avenue, Suite 110, Westlake Village, California 91362-7354. AFCPL’s address is 12/538 Gardeners Road, Mascot NSW 2020, Australia. Please check Exhibit N for agents in other registration states.

We have offered Zenshi Counters in the United States since June 2023. We have offered franchises for AFC Food Service Counters in the United States since May 2002 and in Canada since September 2009. We have offered franchises for Wild Blue Counters in the United States and Canada since June 2021. We are not in any other line of business and have not offered franchises in any other line of business. On April 23, 2015, AFCPL was created to offer and sell franchises in Australia. We are the master Franchisor of AFCPL in Australia. AFCPL is not in any other business and has not offered franchises in another line of business.

Other Parent Companies and Affiliates:

Our ultimate parent is Zensho Holdings Co., Ltd. (“Zensho Holdings”), a Japan limited liability company formed on June 30, 1982. Zensho Holdings does not operate franchises in any line of business. The business address for Zensho Holdings is JR Shinagawa East Building 2-18-1, Konan, Minato-ku, Tokyo 108-0075. Zensho Holdings is affiliated with Zensho USA Corporation, Zensho Food Singapore Pte. Ltd., Pocino Foods Company, Mauri Wasabi, Inc., Coco’s Japan Co., Ltd., Nakau Co., Ltd. and World Food To Go S.L.

Zensho USA Corporation (“Zensho USA”), AFCC’s immediate parent and also our indirect parent is a Delaware corporation formed on January 5, 2015. Zensho USA is a wholly-owned subsidiary of Zensho Holdings. Zensho USA does not operate franchises in any line of business. The business address for Zensho USA is 27261 Las Ramblas, Suite 340, Mission Viejo, California 92691.

Pocino Foods Company (“Pocino Foods”), a wholly owned subsidiary of Zensho USA is a California corporation formed on January 27, 1965. Pocino Foods is an American food manufacturer specializing in premium pastrami and other deli meats, meatballs, and Mexican and Asian-style meats. AFCDC (discussed below) purchases products directly from Pocino Foods and sells those products to our franchisees to be used at Food Service Counters. Pocino Foods does not operate franchises in any line of business. The business address for Pocino Foods is 14250 Lomitas Avenue, City of Industry, California 91746.

Marui Wasabi, Inc. (“Marui Wasabi”), owned 50% by AFCC is a California corporation formed on August 7, 2000. Marui Wasabi is an importer, manufacturer and distributor of wasabi-based products and other Asian style sauces. AFCDC may purchase products directly from Marui Wasabi and sell those products to our franchisees to be used at Food Service Counters in the future. Marui Wasabi does not operate franchises in any line of business. The business address for Marui Wasabi is 13033 Artic Circle, Santa Fe Springs, California 90670.

Zensho Food Singapore Pte. Ltd. (“Zensho Food”), a Singapore limited liability company formed in 2012, is a franchisee of Long John Silver’s, LLC. As of March 2025, Zensho Food operated 19 Long John Silver’s restaurant locations in Singapore. Long John Silver’s restaurants offer fried seafood and chips in a quick-serve restaurant environment. The business address of Zensho Food is 31 Ubi Road 1, #07-02 Annex Building, Singapore 408694.

Coco’s Japan Co., Ltd. (“Coco’s”), a Japan limited liability company, formed on April 5, 1978, is a franchisor of Coco’s restaurants in Japan. As of March 2025, Coco’s had 77 franchised restaurants in Japan. Coco’s restaurants offer a variety of signature soups, hamburgers, salads and combination dinners, in a full-service family-style environment. The business address of Coco’s is the same as Zensho Holdings. Coco’s has offered franchises since 1984.

Nakau Co., Ltd. (“Nakau”), a Japan limited liability company formed in 1966, is a franchisor of Nakau restaurant locations in Japan. As of March 2025, Nakau had 5 franchised locations in Japan. Since March 2005, Nakau has operated as a subsidiary of Zensho Holdings. Nakau restaurants offer donburi (rice bowls) and Kyoto-style udon noodles, in addition to other items, in a fast-food environment. The business address of Nakau is the same as Zensho Holdings. Nakau has offered franchises since 1989.

YO! Sushi UK Limited, (“YO!”), a UK limited company formed on November 24, 1994, is wholly owned by YO! Sushi Limited, which is ultimately a wholly owned subsidiary of Zensho Holdings. YO! operates a combination of franchised and company owned sushi counters in the United Kingdom under the brand YO! Sushi. As of March 2025, there were 477 franchised locations in the United Kingdom, and 33 corporately owned kiosks. In addition to operating sushi counters, YO! also operates a number of company owned Japanese food restaurants in the United Kingdom, and franchised restaurants which are located across Australia, France, the Netherlands, Norway, Spain, Italy, Turkey and the United Arab Emirates. There are no franchised YO! food restaurants in the United States or Canada. As of March 2025, there were 41 company operated YO! food restaurants in the United Kingdom, and there were 24 franchised restaurants globally. The business address of YO! is Fourth Floor, 69 Wilson Street, London, EC2A 2BB, United Kingdom.

JFE Franchising, Inc. (“JFE”), a Texas corporation formed on August 21, 2013, is wholly owned by Snowfox US Holdco Inc., which is ultimately a wholly owned subsidiary of Zensho Holdings. JFE has offered franchised sushi counters in the United States since October 2013 under the brand Snowfox. As of March 2025, there were 1,463 franchised Snowfox locations in the United States. In addition to operating sushi counters, JFE operates 1,180 franchised fresh cut fruit, vegetable and salad within many of the same locations as the franchised sushi counters. As of March 2025, JFE had 2,743 franchised locations in the United States, and 17 company owned location in Australia. The business address of JFE is 2021 Bingle Road, Houston, Texas, 77055.

Snowfox (Ireland) Limited (“Snowfox Ireland”), an Irish registered limited company formed on June 19, 2023, is wholly owned by Snowfox Midco 1 Limited, ultimately a wholly owned subsidiary of Zensho Holdings. Snowfox Ireland operates franchised sushi counters in the Republic of Ireland under the brand Snowfox. As of March 2025, there was 11 franchised Snowfox location in the Republic of Ireland. The business address of Snowfox Ireland is Beaux Lane House. Mercer Street Lower. Dublin 2, Dublin, Republic of Ireland.

Bento Sushi Franchise Inc (“BSFI”), a Delaware corporation formed on April 12, 2016, is a wholly owned subsidiary of Zensho Holdings, is in the business of selling franchises and developing branded products under the name “BENTO SUSHI.” BSFI’s primary business is offering and selling franchises in the United States. BSFI operates a franchise distribution system under a License Agreement dated April 29, 2016 with Bento Inc., an affiliate of BSFI. As of March 2025, BSFI had 63 franchised locations. The principal place of business of BSFI is 501 Cambria Avenue, Suite 124, Bensalem, PA 19020.

Bento Inc ("BI"), an Ontario business corporation formed on November 20, 2017, is ultimately a wholly owned subsidiary of Zensho Holdings. BI has operated company-owned Bento Sushi outlets, and subcontracts other Bento Sushi outlets in Canada since 1996. These outlets are similar to the franchised outlets offered in this disclosure document. As of March 2025, BI had over 166 company-owned and subcontracted outlets in Canada. In addition, BI operates 1913 commissary, central production kitchens, 954 in Canada and 959 in the United States, servicing over 2,000 locations. The principal place of business of BI is 25 Sims Crescent, Unit 1, Richmond Hill, Ontario, L4B 1C9.

Bento Nouveau Inc ("BNI"), a Delaware corporation formed on October 5, 2005, is ultimately a wholly owned subsidiary of Zensho Holdings. BNI operates in the United States only. It has operated company-owned Bento Sushi outlets that are similar to the franchised outlets offered in this disclosure document since 2005. As of March 2025, BNI had 3 company owned outlets in the United States, primarily on the east coast. The principal place of business of BNI is 25 Sims Crescent, Unit 1, Richmond Hill, Ontario, L4B 1C9.

Bento Sushi Franchise Ltd. ("BSFL"), an Ontario business corporation formed on May 22, 2013, is ultimately a wholly owned subsidiary of Zensho Holdings. BSFL offers franchises for Bento Sushi outlets in Canada, consisting primarily of Sushi Counter front and inline units in malls, hospitals, and universities. BSFL has offered Bento Sushi franchises in Canada since May 2013. As of March 2025, BSFL had 63 franchised units in operation in Canada. BSFL does not operate a business of the type to be operated by you.

Bento Sushi USA, Inc. ("Bento USA"), a Delaware corporation formed on August 19, 2020, is ultimately a wholly owned subsidiary of Zensho Holdings. Bento USA offers franchises for retail sushi businesses in the State of Hawaii under the name and marks "BENTO SUSHI." Bento USA has offered Bento Sushi franchises since July of 2021. As of March 2025, Bento USA had 40 franchisees in Hawaii and no company-owned locations. The principal place of business of Bento USA is 1011 Centre Road, Suite 310, New Castle County, Wilmington, Delaware 19805.

Lotteria Co., Ltd, ("Lotteria"), a Japanese Corporation formed in 1972, is a wholly owned subsidiary of Zensho Holdings, Ltd. and franchisor of Lotteria hamburger chain locations in Japan. As of March 2025, Lotteria had 73 franchised locations in Japan under the brand Lotteria. Lotteria offers a variety of classic and unique burger options, fries, drinks, and other fast-food items. The business address of Lotteria is JR Shinagawa East Building, 2-18-1 Konan, Minato-ku, Tokyo, Japan. Lotteria has offered franchises since 1972.

World Food To Go S.L. ("World food To Go"), owned 70% by Zensho EU Corporation, which is also a wholly owned subsidiary of Zensho Holdings, is a Spanish corporation formed on March 10, 2015. World Food To Go operates takeout sushi stands in Spain and, through its wholly owned subsidiaries SushiTake S.R.L., SushiTake S.L.U., SushiTake SIA, SushiTake OY and SushiTake AS, it operates sushi stands in Italy, Andorra, Latvia, Finland, and Norway respectively. As of March 2025, there were 93 franchised locations in Spain, 3 franchised location in Italy and 8 franchised locations in Norway. The Business address of World Food To Go is Avda. De las Nieves 11, 28935 Móstoles, Madrid, Spain.

Other than stated above, Zensho Holdings, Zensho USA, Zensho Food, Pocino Foods, Mauri Wasabi, Coco's, Nakau, YO!, JFE, Snowfox Ireland, BSFI, BI, BNI, BSFL, Bento USA, Lotteria and World food To Go are not in any other line of business and do not currently offer franchises in any other line of business.

The Franchised Business

Our business is granting franchises to let people, like you, operate Zenshi Counters, AFC Food Service Counters, and Wild Blue Counters, which offer prepared sushi and other Asian style foods. Sometimes, due to arrangements with the facility owner, you will operate your Food Service Counter under a different name, or a generic name.

Originally, our franchises emphasized sushi and this continues to be an important part of the franchise. Since approximately September 2005, we broadened our emphasis and now describe ourselves as food service counters. We are not in any other business and haven't offered franchises in any other business. We offer three types of franchises—full-time food service counters, part-time food service counters and self-service food service counters.

Full-time Food Service Counters allow you to operate a Food Service Counter as a department of a retail supermarket or in another kind of location, like a college campus or arena on a full time basis.

In some instances, we may permit you to operate at these facilities on a part-time basis. In part-time locations, you are not required to be personally present or have a manager personally present at the Food Service Counter more than four hours per day. We currently only permit franchisees to operate a part-time location if they already own a full time Food Service Counter.

Self-service Food Service Counters are available only to selected franchisees who already operate a full-time or part-time Food Service Counter with us. Under the self-service franchise, you service a supermarket or other location's sushi and/or other prepared food needs from your existing location. You do not have to be physically present at the self-service location during all hours of operation. It is your responsibility to prepare the prepared foods (such as sushi, roll n' wraps and other foods in our system) at your full-time or part-time Food Service Counter and deliver it at least once daily to your self-service location.

To purchase a Food Service Counter, you must sign our form franchise agreement and a separate addendum for each location to be opened by you. All the addendums are controlled by one franchise agreement.

Under each type of franchise, customers pay the facility owner for their purchases and sales are recorded in the facility owner's cash registers and then reported to us. The facility owner and we keep a percentage of your gross sales. We then return the remainder to you less amounts we deduct for other charges to you. At most locations, you will not use a cash register. At other locations, cash registers will be provided by the location owner for your use (See Items 6 & 11.) We also operate Food Service Counters that are similar to the ones you will operate. See Exhibit M. We are not in any other business.

We have agreements to operate Food Service Counters as separate departments of supermarkets and other venues. In many instances we perform the agreement by us granting you a franchise, so you can operate the Food Service Counter. We enter into agreements with location owners. Entering into a franchise agreement with you to operate at that location enables us to satisfy the agreement. We will tell you available locations when we meet.

Our affiliate AFCPL offers franchises similar to the ones you will operate outside the United States and Canada. As of March 31, 2025, AFCPL had 223 franchised and 189 company owned locations in Australia. AFCPL is not in any other line of business and does not offer franchises in any other line of business.

Our affiliate AFCDC fulfills and ships franchisee orders, is our logistics provider for product shipments sold to you and sells products to third parties. AFCDC is not in any other line of business and does not offer franchises in any line of business.

There is an existing market for sushi and other prepared food products at stand-alone Food Service Counters and restaurants, and also at grocery stores. You will sell prepared foods mainly to customers who shop at the grocery store or visit the venue where your Food Service Counter is located. Customer traffic will be generated primarily by the facility and its owner. You are only permitted to sell your prepared food products at the Food Service Counter(s) we designate. The facility owner has the right to sell competing products at other locations in the facility. The market for sushi and other food products is fairly developed and is enjoyed by customers year round.

You must comply with federal and state laws on operating a restaurant, health, safety and sanitation laws which also include health department inspections, and menu and food labeling laws. This also includes the Hazard Analysis and Critical Control Point (“HACCP”) food safety program adopted by the U.S. Food & Drug Administration, and rules on handling, preparing and serving foods by people with communicable or infectious diseases. Your Food Service Counter may also be subject to laws on disposing hazardous wastes. Some states have laws requiring you to employ a person who is certified in food safety. See Exhibit O for state specific laws that may apply to you.

As an employer, you must comply with laws on minimum wages, overtime, maximum working hours, working conditions, unlawful discrimination, restricting employment of children and other labor laws and the Department of Homeland Security’s E-Verify program, if required by the facility owner.

You will compete with quick service restaurants and other food alternatives where your Food Service Counter is located. You will also compete with company owned stores (if any are located near you, see Item 20), other Food Service Counters, restaurants and people’s other choices for dining and shopping for food.

ITEM 2 BUSINESS EXPERIENCE

President, Chief Executive Officer and Director: Vincenzo Calcagni

Mr. Vincenzo Calcagni has been our President, Chief Executive Officer and Director in Torrance, California since May 2025. Mr. Calcagni served as our General Manager of Operations in Torrance, California from October 2022 to May 2025. Mr. Calcagni was unemployed from March 2022 to October 2022. Mr. Calcagni served as Vice President of Operations for Yoshinoya America in Torrance, California from March 2017 to March 2022.

Treasurer and Director: Noriyuki Honda

Mr. Honda has been our Treasurer and a Director in Torrance, California since April 1, 2026. Mr. Honda served as our Senior Vice President of Product Management & Fruit in Torrance, California from July 2025 to March 2026. Mr. Honda served as Senior Vice President of Product for our affiliate, JFE Franchising, Inc in Houston, Texas from April 2024 to June 2025. Mr. Honda served as our General Manager of Product Management in Torrance, California from June 2022 to March 2024. Mr. Honda served as our General Manager of Research and Development in Torrance, California from August 2021 to June 2022. Mr. Honda served as Chief Operating Officer for Zensho Food Indian Private Limited in Delhi, India from April 2019 to June 2021.

Corporate Secretary: Luciana O’Brien

Ms. O’Brien has been our Corporate Secretary in Mission Viejo, California since April 1, 2026. Ms. O’Brien has been General Counsel and Corporate Secretary for our affiliate, Zensho USA Corporation, in Mission Viejo, California since June 1, 2015.

Executive Director of Research and Development: Masahiko Tajima

Mr. Tajima has been our Executive Director of Research and Development in Torrance, California since May 2025. Mr. Tajima was our General Manager of Research and Development in Torrance, California from June 2022 to May 2025. Mr. Tajima served as our General Manager of Product Development in Torrance, California from January 1, 2021 to June 2022.

Director of Corporate Training: Gerardo Siordia Posadas

Mr. Posadas has been our Director of Corporate Training in Torrance, California since April 2026. Mr. Posadas served as our Director of Legal and Compliance in Torrance, California from May 2025 to April 2026. Mr. Posadas was our General Manager of Compliance in Torrance, California from July 2020 to May 2025.

Vice President of Fruit Business and Process Improvement: Mario Garcia

Mr. Garcia has been our Vice President of Fruit Business and Process Improvement in Torrance, California since December 2025. Mr. Garcia served as Vice President of Operations for Everytable in Los Angeles, California, from March 2023 to December 2025. Mr. Garcia was unemployed from October 2022 to March 2023. Mr. Garcia served as Director of Operations for Yoshinoya, in Los Angeles, California, from March 2016 to October 2022.

Vice President of Business Development & Marketing: Michelle Narain

Ms. Narain has been our Vice President of Business Development & Marketing in Torrance, California since May 2025. Ms. Narain was unemployed from March 2025 to April 2025. Ms. Narain served as Vice President of Sales & Marketing for Sofidel in Horsham, Pennsylvania from November 2024 to February 2025. Ms. Narain served as Vice President of Sales & Marketing for Clearwater in Spokane, Washington from February 2022 to October 2024. Ms. Narain was unemployed in January 2022. Ms. Narain served as Vice President of Private Label for Smart & Final in Commerce, California from May 2018 to December 2021.

Senior Vice President of Operations: Eddie Y. Fujita

Mr. Fujita has been our Senior Vice President of Operations in Torrance, California since April 2025. Mr. Fujita was our Deputy General Manager in Torrance, California from February 2021 to March 2025.

Director of Regulatory and Compliance Affairs: Chuong V. Hoang

Mr. Hoang has been the Director of Regulatory and Compliance Affairs in Torrance, California since April 2026. Mr. Hoang served as our Legal Manager in Torrance, California from May 2022 to April 2026. Mr. Hoang served as our Legal Supervisor in Torrance, California from September 2006 to May 2022.

Vice President of Product Management: Sean Acre

Mr. Acre has been our Vice President of Product Management in Torrance, California since August 2025. Mr. Acre served as Operations Manager for Yoshinoya America in Torrance, California from November 2019 to August 2025.

Vice President of Financial Planning & Analysis: Yoshiya Kohda

Mr. Kohda has been our Vice President of Financial Planning & Analysis in Torrance, California since August 2025. Mr. Kohda served as our Vice President of Product Management in Torrance, California from April 2025 to August 2025. Mr. Kohda served as our Deputy General Manager of Product Management in Torrance, California from April 2023 to March 2025. Mr. Kohda served as our Division Manager of Field Operation in Torrance, California from August 2022 to March 2023. Mr. Kohda served as our Regional Manager of Field Operation in Torrance, California from March 2021 to July 2022.

Vice President of Food Safety and Quality Assurance: Lewis Ennist

Mr. Ennist has been our Vice President of Food Safety and Quality Assurance in Torrance, California since January 5, 2026. Mr. Ennist served as Vice President of Regulatory and Compliance for DrinkPAK, LLC in Santa Clarita, California from March 2023 to January 2026. Mr. Ennist served as Vice President of Quality for DrinkPAK, LLC in Santa Clarita, California from January 2020 to March 2023.

ITEM 3 LITIGATION

PENDING LITIGATION:

A. Pending Cases We Brought Against Franchisees in Fiscal Year Ending March 2025:

None

B. Cases Pending Against Us:

None

CONCLUDED LITIGATION:

Claim of P. Mung

Pau Sian Mung v. Advanced Fresh Concepts Franchise Corp. (United States District Court, Northern District of Georgia, Case No. 1:23-cv-04154, removed September 14, 2023 – “District Court Lawsuit”); *Pau Sian Mung v. Advanced Fresh Concepts Franchise Corp.* (Superior Court of Newton County, State of Georgia, Case No. SUCV2023001844, filed August 11, 2023 – “State Court Lawsuit”); and *P. Mung v. Advanced Fresh Concepts Franchise Corp.* (American Arbitration Association, Case No. 01-23-0004-3850, initiated October 5, 2023 – the “Arbitration”). On July 21, 2023, AFC terminated its franchise agreement with Pau Sian Mung (“Claimant”) pursuant to the provisions of the franchise agreement based on Claimant’s unlawful trespass onto another franchise operator’s premises and theft from another franchise operator. On August 11, 2023, Claimant initiated the State Court Lawsuit. On September 14, 2023, AFC removed the State Court Lawsuit to District Court Lawsuit. After AFC filed its motion to dismiss or stay the District Court Lawsuit pending arbitration, Claimant stipulated to a stay of the District Court Lawsuit and the District Court entered an order staying the matter pending an award issued in arbitration. On October 5, 2023, Claimant initiated the Arbitration with the American Arbitration Association (“AAA”). Claimant’s arbitration demand asserted his franchise agreement was wrongfully terminated by AFC and claimed causes of action for breach of contract and breach of the covenant of good faith and fair dealing. Claimant’s arbitration demand sought damages “in excess of \$150,000.” On March 1, 2024, Claimant dismissed without prejudice the District Court Lawsuit against AFC. On March 8, 2024, the Arbitration was dismissed without prejudice by AAA because Claimant failed to pay AAA the deposit amount of \$1,250.00.

Claim re Pau Sushi Catering, LLC

Pau Sushi Catering, LLC v. Advanced Fresh Concepts Food Services Corp. (American Arbitration Association, Case No. 01-19-0001-4357, filed May 10, 2019). Pau Sushi Catering, LLC (“Claimant”) operated an AFC Food Service Counter within a Publix Supermarket in the Orlando, Florida, area until July 19, 2018. Claimant’s franchise agreement was terminated when we discovered Claimant’s operations violated our zero tolerance policy for using carbon monoxide treated tuna in products at Publix Supermarket locations. Claimant’s arbitration demand contends the immediate termination amounted to a breach of the franchise agreement by us and that our actions also constituted fraud, negligent misrepresentation, unlawful business practices and racial discrimination, among other claims. Claimant asserted its damages exceeded \$ 500,000. The arbitration was initiated on May 10, 2019. On August 4, 2020, Claimant and AFC agreed in writing to resolve the arbitration for mutual general releases and the dismissal of the arbitration with prejudice. On August 17, 2020, the arbitration was ordered closed based on the August 4, 2020 agreement.

Claim of Cherry Lee

Cherry Lee v. Soe Tun and Advanced Fresh Concepts Food Services Corp. (Contra Costa County Superior Court Case No. C18-01063, filed May 23, 2018, dismissed with prejudice on January 7, 2019). Plaintiff was employed as a sushi chef by our franchisee, Soe Tun, between August 2017 and February 2018. On May 23, 2018, Plaintiff initiated this action against our former affiliate, Advanced Fresh Concepts Food Service Corporation (“AFCFSC”) and Soe Tun alleging claims for hostile work environment, retaliation, failure to prevent harassment/retaliation, negligent supervision, sexual battery and a violation of section 226 of the Labor Code. The full scope of the alleged damages was uncertain but included claims for emotional/physical distress and approximately 3 months of lost income of \$1,600 per month. Plaintiff’s principal theory against AFCFSC was based on Soe Tun’s and AFCFSC’s alleged joint employment with Soe Tun of Plaintiff. Soe Tun and AFCFSC answered the complaint and denied the allegations. On December 21, 2018, Plaintiff executed a settlement agreement and agreed to settle her dispute for a total payment of \$5,000.00 in exchange for a dismissal with prejudice of AFCFSC, general release of AFCFSC and all its affiliated entities, including Advanced Fresh Concepts Corp. and an express acknowledgement in writing that the settlement did not constitute any evidence or admission of wrongdoing by AFCFSC. The dismissal with prejudice of AFCFSC was entered on January 7, 2019.

Claim of Pilrang Owa

Advanced Fresh Concepts Franchise Corp. v. Pilrang Owa d.b.a. Sakura Foods Everett L.L.C. (American Arbitration Association Case No. 01-16-0002-8871, Los Angeles, California, filed July 19, 2016). We initiated an arbitration proceeding against Pilrang Owa doing business as Sakura Foods Everett L.L.C. (“Owa”) seeking an order finding and declaring Owa owned and operated an AFC Food Service Counter by and through her own, independently run company, Sakura Foods Everett, L.L.C. and therefore was not our employee (“Owa Arbitration”). We did not seek damages with respect to the relief requested, but recovery of all fees and costs incurred for the dispute. Thereafter, Owa filed a counter-claim against us in the arbitration proceeding seeking \$6.8 million dollars in damages. We filed the arbitration demand after learning that Owa filed a motion to amend her complaint in the action entitled *Pilrang Bae Owa v. Fred Meyer Stores, et al.* (Superior Court of Washington for King County, Case No. 16-2-09786-3 SEA, filed April 16, 2016 - the “State Court Action”) to include us as a defendant on the basis that she was allegedly our employee. Owa contended in the State Court Action that we discriminated against and harassed her when conducting inspections of her franchise operation and by sending her notices to cure breaches of the franchise agreement. Owa claimed the discrimination and harassment was based on a protected classification in violation of Washington state laws and, based thereon, sought unspecified amounts of monetary damages. We contended Owa signed a franchise agreement with us whereby she was an independent business owner that operated a Food Service Counter and was not our employee. On August 5, 2016, Fred Meyer Stores removed the State Court Action to the U.S. District Court, Western District of Washington (Case No. 2:16-cv-01236 – the “First District Court Action”). On September 9, 2016, we moved to compel arbitration of Owa’s claims in the First District Court Action. On November 28, 2016, Owa filed a separate virtually identical action in the U.S. District Court, Western District of Washington (Case No. 2:16-cv-01832 – “Second District Court Action”). On December 15, 2016, the court granted our motion to compel resolution of all claims between the parties within the Owa Arbitration, stayed the First District Court Action pending the results of the Owa Arbitration and dismissed the Second District Court Action. On November 28, 2017, the arbitrator issued a comprehensive final award in our favor and against Owa (“Final Award”). The Final Award included an award of attorney’s fees and costs to us in the amount of \$373,126.98. On May 29, 2018, the District Court confirmed the Final Award and entered it as a judgment in our favor. On June 23, 2018, Owa appealed the arbitrator’s ruling to the Ninth Circuit Court of Appeals, Case No. 18-35531. On October 5, 2018, AFC and Owa reached an agreement to settle their dispute and executed a formal settlement agreement on October 16, 2018, whereby Owa would dismiss her appeal with prejudice, AFC would execute a satisfaction of judgment as to the Final Award for filing in the First District Court Action and, except as to the judgment entered in the First District Court Action, the parties would mutually and generally release each other. On November 20, 2018, an order entering Plaintiff’s dismissal of her appeal was entered and AFC conveyed the satisfaction of judgment form to Plaintiff for her filing and use in the First District Court Action with respect to the Final Award.

Claim of Zaw Min Oo

Z. Oo v. Advanced Fresh Concepts Franchise Corp., et al. (American Arbitration Association Case No. 01-15-0005-1350, Los Angeles, California, filed September 24, 2015). Claimant Z. Oo initiated an arbitration proceeding against Ryuji Ishii and AFCC alleging damages based on breach of contract for: (i) commission rates that were inaccurate or improperly reduced; (ii) improper establishment of new franchise locations within the vicinity of Claimant's franchise operations; (iii) improper and/or unauthorized deductions from royalty payments; and (iv) improper and/or unauthorized charges for franchise renewals. Claimant sought total damages of \$990,000. On February 24, 2016, Mr. Ishii and AFCC were dismissed and we (Advanced Fresh Concepts Franchise Corp) were substituted into the matter as respondent. We answered the Arbitration Demand denying the allegations, any wrongdoing and any damages sustained by Claimant. On March 8, 2016, we filed a counter-arbitration demand for declaratory relief seeking an order terminating Claimant's franchise operations for his breach of the franchise agreement. We also simultaneously sought a preliminary restraining order suspending all of Claimant's franchise operations pending a final decision on our request for declaratory relief. On April 13, 2016, the Arbitrator issued a preliminary injunction against Claimant, suspending his franchise operations pending resolution of our declaratory relief claim for termination. Claimant then surrendered his operations to us on April 14, 2016. A hearing on the merits was held on April 18-19, 2016. On May 12, 2016, an Award was issued for us and against Claimant with regard to our declaratory relief claim seeking the termination of Claimant's franchise operations. However, the Award also granted Claimant \$280 in damages for tablet charges, \$50 for on-line ordering charges and a nuisance award of \$1,000 for automated tuna shipments. The Arbitrator also awarded Claimant his administration costs for the arbitration in the amount of \$11,200. Finally, the Award found that neither party qualified as a prevailing party, including on our counter-arbitration demand and therefore denied all parties any recovery of attorney's fees and costs.

Other than these actions, no litigation is required to be disclosed in this Item.

ITEM 4 BANKRUPTCY

No bankruptcies are required to be disclosed in this Item.

ITEM 5 INITIAL FEES

If you are a new franchisee obtaining a full time location, you pay us an initial franchise fee of \$6,250. In addition, you pay us a \$100 credit and background check fee when turning in your application, up to \$2,300 for our training program for each of your principal owner(s), up to \$2,300 for each manager you bring with you to the initial training, up to \$275 per person for the ServSafe® Food Protection Manager Certification (for you and your managers), up to \$1,000 per person for drug, tuberculosis and criminal background testing and a manual lease fee of up to \$600 for each full service or part time Food Service Counter to be opened. You pay the training fee, ServSafe® training and examination fee and manual lease fee in a lump sum when you start training. You pay the drug, tuberculosis and criminal background test fee and/or the cost of other testing required by the facility owner after the tests/check is completed through deduction from your commissions.

If you are an existing franchisee with us obtaining a self-service or part-time franchise in addition to your existing full time location, there is currently no initial franchise fee for the self-service or part-time location (although we can implement such a fee in the future). If you want to open an additional full time location, we charge the following for each additional full time location to be operated pursuant to your franchise agreement:

Number of Months Remaining on Your Franchise Agreement (on effective date of the addendum)	Initial Fee Per Location
48-60	\$6,250
36-47	\$5,000
24-35	\$3,750
12-23	\$2,500
Less than 12	\$1,250

You pay the initial franchise fee in a lump sum on signing each full time location addendum. There are no refunds or prorations if a location starts as a full time location and later is transformed into a self service or part-time location. However, if a location starts as a self service or part-time location and is transformed into a full time location, then you must pay our then current initial franchise fee for the full time location.

If you fail to complete our training program to our satisfaction or if you fail any required drug, tuberculosis or other chemical and disease testing and/or criminal background investigation, we may cancel the franchise agreement.

Before opening, we require you to purchase a label machine consisting of a tablet and printer and warranty* costing up to \$1,699. The cost of the label machine will vary, depending on the type of tablet, printer and warranty you decide to purchase in accordance with the requirements in the manual. We also require you to purchase equipment and small wares costing up to \$46,000, opening food inventory which depending on what you order can range from \$10,400 to \$31,200 at a full-time or part-time service location and \$1,625 to \$6,500 at a self-service location, scanner costing up to \$500, ongoing inventory which for 3 months can range from \$6,500 to \$23,400 at a full-time or part-time service location and \$1,300 to \$6,500 at a self-service location, signage which depending on your location can cost up to \$1,000, up to \$1,800 in opening assistance fees if we stay at your location 4 additional days beyond the first 3 for on-site training and up to \$350 for four additional sets of uniforms.

None of these fees is refundable. Except as indicated above, these initial fees are uniform to all new franchisees, though we may change them in the future.

If you are an entity, each of your owners who are individuals must sign a personal guaranty. The guaranty is on the signature page of the franchise agreement and each applicable addendum.

If you purchase an existing location from us, we will charge you \$1,000 to \$100,000 for the Food Service Counter business, assets, equipment and value of the established market of the Food Service Counter, as we determine at our sole discretion.

We may finance some of the initial franchise fee(s) and various other expenses that you incur with us. (See Item 10.)

* These items are not required when you purchase a self-service franchise, because you already have these items in your full-time or part-time location.

ITEM 6 OTHER FEES (1)

Name of Fee	Amount	Due Date	Remarks
Compensation to Franchisor (2), (3)(4)	Varies. Typically 25% to 27% of Gross Sales to the store or other facility where you are located, and 8% to 11% of Gross Sales to us. (2)(4)	Monthly	Our (or our parent's) agreement with the store says they keep a percent of your gross sales (25%, for example). We keep a percent (8%, for example). We return the rest to you (typically, 67%) less amounts we deduct for other

Name of Fee	Amount	Due Date	Remarks
			charges to you. These percentages can vary, but the amount paid to us will generally not exceed 11% of Gross Sales. See Footnotes 3 & 4.
Banners, logo items and displays (3)(5)	Actual cost	After ordered	These are items like umbrellas or carved wood signs. Prices vary depending on the type of item and supplier. You pay us if you buy these optional items from us.
Additional Training (3)	Up to \$2,300 per person	After training	If you elect and request us to train your managers at our headquarters or other location we designate. This fee will vary, depending on whether you request us to train your manager(s) in both steam table and sushi training or only sushi training.
On-site additional Training (3)	Up to \$450 per day	After training is completed	If we go to your site to train you and/or your managers.
Failure to Attend Additional Training (3)	\$250	Payable if you fail to attend required training	If you fail to attend any required training, we may assess this fee and deduct it from commissions payable to you.
ServSafe® Food Protection Manager Training and Certification (3)(6)	Up to \$275 per person	After course is taken	Charge for training and certificate for you or your managers.
Testing and Criminal Background Checks (3)	Up to \$1,000 per person. Typically, around \$100 per person (if only background check required).	After test/check is completed	Charge for conducting drug and tuberculosis tests and criminal background checks on you and your personnel.
Manuals Lease Fee (3)	Up to \$600 for each full-time or part-time Food Service Counter you operate	After manuals provided.	You pay a lease fee of \$100 for the Operating Manual, \$100 for the Standard Sanitation Operating Procedure and Methods Manual, up to \$200 for the Sushi Recipe Guide and \$100 for the Steam Table Operating Manual and Wild Blue Recipe Guide (if applicable to you) for each full or part time location you operate. The fee is refunded when you return the manuals to us within 30 days of the expiration or termination of your location. Otherwise, there is no refund.
Customer Satisfaction Fee (3)	Up to \$1,000 per complaint	On demand	Charge to compensate us for our efforts in addressing and resolving customer complaints against you or your franchise.
Account Broker Fee	\$100 - \$500 per quarter for each Food Service Counter you operate.	Quarterly	If we pay a fee for the right to locate the Food Service Counter in the facility or store, you reimburse us for the amounts paid, not to exceed \$500 per quarter for each Food Service Counter subject to this fee.

Name of Fee	Amount	Due Date	Remarks
Additional Uniforms (3)	Up to \$350	On demand	If you want to purchase additional uniforms. Cost is for four sets of uniforms.
Default Charge (3)	Up to \$1,000 per default	On request	You pay this fee if you default on your obligations as specified in the operating manuals or franchise agreement.
Web and Data Access Charge (3)	Up to \$100 per month for each Food Service Counter you operate.	Monthly	You pay this fee to gain access to our website pages that let you submit purchase orders online as well as information on new products, product specifications, tablet data and other information. This fee also includes access to our inventory tracking software, which lets you and us track the daily inventory of products made at your Food Service Counter.
Pricing Labels (3)	Our actual cost incurred (estimated to be \$500 per item for which price is changed)	When you decide to charge different prices requiring us to print special price labels	To charge prices that differ from pricing we print on labels, the label machine must be reprogrammed. You pay or reimburse the amount charged to us by the vendor for our computer programming to print labels with pricing you want.
Product Purchases – Ancillary Charges (3)	Actual cost	After shipping	You buy food and other items from us, our parent, our affiliate or authorized suppliers. You also pay freight, and other ancillary charges.
Extended Producer Responsibility Fee (EPR)	Up to \$2000 per month	If and when required by your state’s regulator	Based on the Extended Producer Responsibility (“EPR”) laws in certain states that require collection of this fee, we will require you to reimburse us for our payment of this fee, subject to state law. Only certain states have laws that regulate paper, plastic and packaging, which currently include California, Colorado, Michigan, Oregon and Maine.
Reimbursement for Employee Wages Paid (3)	Actual cost	If and when required by the facility owner.	If the facility owner, due to labor contracts or otherwise, requires your Food Service Counter(s) employees to be employed directly by the facility owner, and we are asked to reimburse the facility owner for these employment costs, we will then deduct such payments from the amounts due to you.
Transfer Fee (3)	\$1,500 per location	When you ask us to consent.	You must pay us this fee for each location to be sold.

Name of Fee	Amount	Due Date	Remarks
Transfer to Entity Fee (for individuals wishing to transfer their interest in the franchise agreement to a newly formed entity controlled by them) (3)	No charge for first request to transfer to entity. \$250 for each subsequent request.	When you desire to transfer your interest in this agreement to an entity you control.	You must pay us this fee each time you seek our consent to you transferring your interest in the franchise agreement to another entity controlled by you.
Renewal Fee (3)	Our then current initial franchise fee for new franchisees.	When you renew your agreement for another term.	You pay this fee to renew your agreement for another term.
Audit (3)(7)	1% per month (12% per year) interest; cost of audit	When we request, following the audit	You pay this if an audit by us indicates a discrepancy in your books or under-reporting of sales by 1% or more for any period.
Management Fee (3)	Up to \$450 per day per person we send	When we request.	When you open, if we stay with you after three days (we don't charge for the first three days); or if we operate the business for you for any period of time.
Direct Deposit Fee (3)	\$5 per month	On demand	We make all payments to you via direct deposit. You will receive monthly statements via email or you may access the monthly statements online using the AFC Connect portal. In rare circumstances, we may need to send your commissions via a manual check. In those circumstances, we will send these via UPS at a cost of up to \$25 per month or at your option via regular mail at no additional cost.
Shipping Administrative Fee (3)	Up to 2 ½% of total purchase price	On demand	We charge this fee to defer our administrative and other costs of shipping products to your Food Service Counter.
Insurance (3)(8)	Varies	When we request.	If you don't get insurance we require, then we can get it for you (though we don't have to) and you must pay for the insurance or reimburse us or we can deduct the cost from amounts we owe you.
Indemnification (3)	Actual cost	On demand.	You indemnify us concerning your Food Service Counter and all government imposed taxes, fees, charges, fines, and penalties imposed on your operations.
Expenses Caused by Breach (3)	Actual cost	On demand	You must pay us all expenses we incur due to your breach or default.

Name of Fee	Amount	Due Date	Remarks
Request for Approval of New Product, Supplier or Vendor (3)(9)	\$500 plus our out of pocket investigation expenses	If requested	If you request to sell a non-approved product, or use a non-approved supplier or vendor, you pay our investigation expenses and a fee of \$500.
Mailing and Reproduction Costs (3)	Varies	On demand	If we send you materials such as manuals or marketing materials for your location, we may charge you a reproduction, service and handling charge up to \$100 per shipment.
Warranty Service for Labeling Machine (3)	Varies, currently \$99 for the first two years or \$199 for the first three years	On demand	To renew your labeling machine warranty after the first two or three years of operation, respectively.
Lab Test (3)	Up to \$500 per sample tested	On demand	If we order a lab test to examine food in your facility, you must pay up to \$500 for each sample tested.
Early Termination Fee (3)	\$1,500 per location	On demand	If you abandon any location or if your franchise agreement or any addendum is terminated before the end of the term, we can assess this fee against you for each location terminated or abandoned.
Advertising Cooperative Fee	Varies	On demand	If an advertising cooperative is formed in your area, you must participate in and contribute to the cooperative according to its procedures.
Advertising Contribution Fee	Actual costs	When we request, following initiation of the campaign	If we conduct any regional or national advertising campaigns, any geotargeted marketing campaigns, or national news and weather campaigns for your brand, we can bill you your pro-rata share of such advertising. We may absorb some of the cost, but have no obligation to do so.
Administrative Fee (3)	Up to \$100 per garnishment/levy request	On demand	Reimbursement for our costs and expenses for complying with tax levies and wage garnishments issued against you or your owners.
Promissory Note Payments (if applicable)	Actual costs	Monthly	Payable if you buy an existing location from us and request financing. See Item 10.
Late Fee under Promissory Note	1% of delinquent amount (or highest rate allowed by law, whichever is lower, which is currently 10% annually in California)	On demand	Payable if you are late in paying monthly Promissory Note Payments more than 10 days.
Third Party Audits and Charges	Actual costs as incurred	On demand	Payable if we are charged by third parties for audits, inspections, fines and/or charges imposed or levied against the Food Service Counter, including food safety, facility audits and customer service.

Name of Fee	Amount	Due Date	Remarks
Third-Party Delivery Fee (3)	Varies, 0% to 6.5% of Gross Sales of delivered food	Monthly	<p>Our (or our parent's) agreement with the store or other facility may allow that they keep a percent of Gross Sales to reimburse the store or facility for third-party delivery fees they incur for delivery of your products, such as through Grubhub and DoorDash. If a Third-Party Delivery Fee is assessed for food ordered from you, it will be deducted from the amount returned to you as follows:</p> <ol style="list-style-type: none"> 1. The full Third-Party Delivery Fee will be deducted from the amount paid to you; or 2. At our discretion, we can agree to share the cost of the Third-Party Delivery Fee with you; or <p>Alternatively, the store or facility may directly charge you for the Third Party Delivery Fee.</p> <p>See Footnote 3.</p>
Local Store Marketing Expense	Varies, 0% to 0.25% of Gross Sales to the store or other facility where you are located	Monthly	<p>Payable if the store or other facility charges us for local marketing initiatives for the Food Service Counter, such as on-site advertisements, coupon offers, social media, mailers and other advertising programs.</p> <p>See Footnote 3.</p>

Footnotes:

- (1) All fees are imposed by and are payable to us, our affiliate or to AFCC. Fees are uniformly imposed. All fees are non-refundable. If you are an entity, each of your owners who are individuals must sign a personal guaranty. The guaranty is on the signature page of the franchise agreement and each addendum. As of March 2025, there were no purchasing or advertising cooperatives. Accordingly, franchisor owned outlets did not have voting power on any fees imposed by such cooperatives.
- (2) "Gross Sales" means all sales and revenues whatsoever derived from your business, in any form, except that sales tax, credits or refunds are not part of Gross Sales.
- (3) Payable by deduction from our payments to you. The deduction appears on a monthly statement.
- (4) You do not receive direct payment from your sales. All sales will be through registers owned or operated by the facility owner. The facility owner forwards payments to us, less any amount to be retained by them under their agreement with us. We retain a compensation fee together with other charges owed to us or AFCC. We return the rest to you. These amounts may vary according to the facility. The amounts are typically 62% to 67% paid to you (less amounts you owe us), 25% to 27% to the facility owner and 8% to

11% to us (plus any amounts you owe us.) If we negotiate a different amount to the facility owner then the percentage to you and us may be different. More often, if different, you will receive a higher percentage, but not always. When the percentage to you is lower, it is usually a location we expect to have a higher volume of sales. As an example, at a prominent university the facility owner retains 30%. We retain 6% and the operator receives 64%, but it is a higher volume location. We will pay you your percentage usually within 30 days after receiving the sales report and payment for the applicable period from the facility owner. Our sole responsibility is to remit to you the agreed commission percentage on amounts actually received from the facility owner. We have no responsibility under any circumstances to pay any commission to you on amounts not received from the facility owner. If we pay your commission in any given month before receiving payment from the facility owner and the facility owner does not pay us as required, you must reimburse us the commissions paid to you. You must also reimburse us any amounts paid to you, if we discover such amounts were paid in error, for example, if the facility owner requests a refund due to overpayment in any given period or if we otherwise overpay you. We can withhold any overpayment from future payments due to you.

- (5) Your cost may vary because there are different suppliers of logo items and banners and costs depend on the particular marketing tools selected. Other items could include umbrellas and/or carved wooden signs. Typically, prices are in the range of \$250 to \$1,000.
- (6) We and many jurisdictions require you to have a food safety certificate to operate a business serving food to the public. Every Food Service Counter must have at least one ServSafe® Food Protection Manager certified person onsite during all operating hours. We charge this fee when we train you and your manager.
- (7) “Discrepancy” means any discrepancy between data reported by the facility owner and you. The data reported by the facility owner will control. “Underreporting” means there were sales not included in your sales report to us.
- (8) If we choose, we can arrange to get insurance on your behalf, although we have no obligation to do so. If we do, you reimburse us.
- (9) If you want to offer something we haven’t approved or buy from a supplier we haven’t approved, we can charge you or the supplier for expenses we incur in our investigation. The fee will depend on the extent of the investigation needed. You must notify us in writing and provide us samples and other information we need to check out the product or supplier. See Item 8.

ITEM 7 ESTIMATED INITIAL INVESTMENT

YOUR ESTIMATED INITIAL INVESTMENT

ESTIMATED INITIAL INVESTMENT FOR ONE NEW FULL-TIME FOOD SERVICE COUNTER OR PART- TIME FOOD SERVICE COUNTER LOCATED IN A GROCERY STORE OR OTHER LOCATION OWNED BY A THIRD PARTY(1)

Item	Amount	Method of Payment	When Due	To Whom Paid
Initial Fee (2)	\$6,250 (\$0 for a Part-Time Location)	Cash on signing.	On signing franchise agreement.	AFC
Credit and Background Check Fee (3)	\$100	Cash	When turning in application to become a franchisee.	AFC
Tuberculosis, Drug Testing and Criminal Background Checks (4)	\$100 - \$2,000	We deduct from commissions we pay you.	Shortly after opening.	AFC

Item	Amount	Method of Payment	When Due	To Whom Paid
Training Fee (5)	\$1,000 - \$4,600	Cash	Start of training.	AFC
Training Fee for your managers (6)	\$0 - \$2,300	Cash	Start of training.	AFC
ServSafe® Food Protection Manager Training, Testing and Certification (7)	\$275 - \$550	Cash	Before opening for business.	AFC
ServSafe® Allergen Awareness Training and Testing (7)	\$10 - \$30	Cash	Before opening for business.	ServSafe®
Travel and Living Expenses while Training (8)	\$1,600 - \$11,500	As incurred.	During training.	Airline, hotel, restaurant
Operating Manual/SSOP/ Sushi Recipe Guide/ Wild Blue Recipe Guide/ Steam Table Manual Fee (9)	\$300 - \$600 (\$100 per manual; up to \$200 for the Sushi Recipe Guide)	Cash	Start of training (for new franchisees) and when opening another location (for existing franchisees).	AFC
Purchase of already existing AFC operated Food Service Counter from us (10)	\$1,000 - \$100,000	Cash.	On closing if you buy an existing location from us.	AFC
Opening Food Inventory (11)	\$10,400 - \$31,200	Cash before opening, or we can deduct from commissions we pay you.	Before opening business or over time by deduction from commissions we pay to you.	AFC
Signage (12)	\$0 - \$1,000	Cash	Before opening business.	AFC
Opening Assistance (13)	\$0 - \$1,800	Cash or we deduct from commissions we pay you.	Shortly after opening for business or over time by deductions from commissions we pay you.	AFC
Labeling machine (Tablet and label printer) and inventory scanner (14)	\$900 - \$2,000	Cash on purchase, or we can deduct from commissions we pay to you; supplier will require cash.	Before opening for business or over time by deduction from commissions we pay to you.	AFC
Warranty Service for labeling machine (Tablet) (15)	\$99 - \$199	Cash or we deduct from commissions we pay you.	Before opening for business or over time by deduction from commissions we pay you.	AFC
Data and Web Access Fee for Tablet (16)	\$120 - \$225	Cash or we deduct from commissions we pay you.	Shortly after opening and over time by deduction from commissions we pay you.	AFC

Item	Amount	Method of Payment	When Due	To Whom Paid
Equipment and Small Wares (17)	\$14,700 - \$46,000	Cash or we deduct from commissions we pay you.	Before opening for business or over time by deduction from commissions we pay you.	AFC or suppliers
Insurance (per location) (18)	\$700 - \$5,000	Cash	When incurred.	Insurance company/AFC if we obtain the insurance on your behalf
Additional Uniforms (19)	\$0 - \$350	Cash	Before opening.	AFC
Licenses & Permits (20)	\$300 - \$2,000	Cash or by deductions from commissions we pay you.	Before or shortly after opening.	Government Agencies/AFC if we assist in obtaining these for you
Computer and Internet Access (21)	\$150 - \$800	Cash	Before opening	Third parties
Additional Funds -3 months (22)	\$7,000 - \$30,400	As incurred	As incurred	employees, suppliers, utilities and AFC
Professional Advisor (23)	\$1,000 - \$2,000	Cash	When incurred before opening.	Your Professional Advisors
Account Broker Fee (24)(first quarterly payment per location)	\$0 - \$500	Cash	When incurred.	AFC
Total for a new full-time or part time Food Service Counter franchise (25)	\$45,004 - \$151,404 (if you do not purchase an existing AFC operated location from us) \$46,004 - \$251,404 if you purchase an existing AFC operated location from us (see FN 10)			
Total for existing franchisee adding a new full-time or part-time Food Service Counter (26)	\$42,019 - \$130,324 (if you do not purchase an existing AFC operated location from us) \$43,019-\$230,324 if you purchase an existing AFC operated location from us (see FN 10)			

Footnotes:

(1) This table provides estimates for one full or part-time Food Service Counter located inside a grocery store or similar location. This table estimates your initial investment from the period before your Food Service Counter opens for business, until about 3 months of operations. We used our experience in operating and working with franchisees to make these estimates. These are only estimates. Your expenses will be higher if you plan to operate more than one full-time or part-time Food Service Counter. We only permit you to operate a part-time location if you already own a full time location. Unless indicated otherwise, all amounts payable are non-refundable. See item 10 for financing we provide.

(2) We charge an initial fee for each full time location operated under the franchise agreement. Currently, we do not charge an initial fee for a part-time location. We determine the fee as follows:

Number of Months Remaining on Your Franchise Agreement (on effective date of the addendum)	Initial Fee Per Location
48-60	\$6,250
36-47	\$5,000
24-35	\$3,750
12-23	\$2,500
Less than 12	\$1,250

You pay the initial franchise fee in a lump sum on signing each full time location addendum. The low estimate assumes you are an existing franchisee opening an additional part time location where no franchise fee is charged. The high estimate assumes you are a new or existing franchisee purchasing a full time location with 48 or more months left under your Franchise Agreement.

(3) You pay us the credit and background check fee when you provide us your completed application to become a franchisee. We do not charge this fee if you are an existing franchisee opening an additional location.

(4) Whenever we or the facility owner requests, you and your specified personnel must undergo drug, tuberculosis and other chemical and disease testing and/or criminal background investigation. The low estimate assumes a criminal background check for one person only. The high estimate assumes we or the facility owner require drug, tuberculosis and other chemical and disease testing as well as a criminal background investigation on two persons (you and one helper). If you fail any required drug, tuberculosis or other chemical and disease testing (which we or the facility owner requires) or any criminal background investigation we may cancel the franchise agreement and keep the fees paid to us.

(5) You pay us when training starts. If the franchisee is an entity, each of the franchisee's principal owners must attend our training. Principal owner means any individual who owns directly or indirectly 30% or more of the entity. If you (or your principal owner(s)) do not complete training to our satisfaction we may cancel the franchise agreement and keep the fees paid to us. There is no training fee for an existing previously trained franchisee adding an additional franchised location. The training fee includes the purchase price of 2 sets of uniforms. The low estimate assumes only one person receives sushi training. The high estimate assumes two persons receive steam table and sushi bar training.

(6) You pay this fee if you elect and request to bring a manager to our initial training program. The low estimate assumes you do not bring a manager to the initial training program. The high estimate assumes you bring a manager and the manager receives both steam table and sushi training.

(7) Every Food Service Counter must have at least one ServSafe® Food Protection Manager certified person onsite during all operating hours. We charge this fee when we train you and your manager. The low estimate is for training and cost of exam for one person taking the manager certification training. The high

estimate applies if two people take the manager certification training. You must also enroll in the ServSafe® Allergen Awareness Training offered online by ServSafe® and pass the training exam before starting operations. We require proof that you completed the training and passed the exam prior to the last day of orientation training. See Item 11.

(8) Expenses to travel to location of training, which may be, in our discretion in California, and for hotel and meals during our training program (including food certification training). There is no training fee for an existing franchisee adding an additional location to their existing agreement. This estimate assumes you spend \$400 to \$1,000 for round trip airfare per person, 10 to 25 nights in a hotel at \$100 - \$150 per person per night, and \$200 - \$1,000 per person for meals. The low estimate assumes only you are trained in our 10 day sushi training program and that you already have a food manager certificate. The high estimate assumes you and a manager are trained in the 10 day sushi program, 2 day food certification training and 13 day steam table training programs.

(9) We charge a manual lease fee for each operating manual we provide to you. Currently, these are our Confidential Operation's Manual, Standard Sanitation Operating Procedure Sushi Recipe Guide, Wild Blue Recipe Guide and Methods Manual and Steam Table Manual (if applicable to your franchise). You will receive one set of manuals for each full-time and part-time Food Service Counter you operate. The manual lease fee you pay is refunded to you when you return the manuals to us on termination or expiration of your agreement.

(10) If you purchase an existing Food Service Counter from us or our parent, we will charge you our estimate of the fair market value of the Food Service Counter, taking into account the revenue, assets, equipment and value of the established market of the Food Service Counter sold to you. You will either sign our form of Asset Purchase Agreement attached as Exhibit I, if the sale includes the assets and equipment of the Food Service Counter, or our form of Food Service Counter Transfer Agreement, attached as Exhibit J, if the sale does not include the sale of assets and equipment of the Food Service Counter.

(11) Estimated cost for opening food inventory. We try to have the opening food inventory at your location when you arrive to start the business. The low estimate assumes you only operate a steam table Food Service Counter. The high estimate assumes your Food Service Counter offers both sushi and steam table foods.

(12) For a Food Service Counter in a grocery store, the store will usually purchase and own the display case(s), signage, refrigerator, ice machine, preparation tables, storage racks, sinks and similar equipment. The high estimate of \$1,000 assumes you buy optional decorative umbrella(s), sign(s) or banner(s) with words or slogans we approve.

(13) After opening, we will stay at your location up to three days at no charge. If you ask, or we determine, that our employee needs to stay longer, we charge you \$450 per day. The low estimate assumes that our employee does not stay beyond three days. The high estimate assumes our employee stays with you four additional days (7 days total).

(14) Estimated cost for Tablet and printer to print price and ingredient labels for the products you sell and an inventory scanner to track your daily inventory of products made at your food service center. The cost of the label machine will vary, depending on the type of tablet and printer you decide to purchase in accordance with the requirements in the manual. The low estimate assumes you already have the printer and scanner needed at your location. The high estimate assumes you are required to purchase a Tablet, printer and inventory scanner.

(15) Estimated cost for warranty service for the first 24 months or for the first 36 months, respectively for the labeling machine.

(16) Estimated 3 month cost for the data and web access fee for the Tablet you purchase, currently \$40 per month. The high estimate assumes fee increases to \$75 per month.

(17) Estimated cost for smallwares and additional equipment consisting of items like a rice cooker, rice sheeter, storage containers, utensils, heated display case, delivery containers, refrigerators, steam table equipment (if required for your franchise), cooking equipment (if required for your franchise), Perfect Fryer, TurboChef Oven and related items.

(18) Estimated one year premium for required insurance. Insurance premiums may vary based on sales. If we pay on your behalf, you reimburse us.

(19) Estimated cost for four additional uniforms, including a hat, a coat and an apron beyond those you receive at the initial training. Low estimate assumes you choose not to purchase additional uniforms. The high estimate assumes you purchase these additional uniforms.

(20) Estimated costs for retail food license and business license which typically must be obtained from the City, County and/or State. At our election, we have the right, but no obligation, to obtain any required licenses and permits in your name. You grant us a power of attorney to apply for any required licenses, permits and any renewals of these for your food service counter(s). You reimburse us for any costs and fees incurred by us in applying for these licenses and/or permits on your behalf.

(21) Estimated costs for computer and Internet access. The low estimate assumes you already own a computer or laptop capable of Internet access and must only pay for Internet service through your preferred provider. The high estimate assumes you purchase a computer with Internet connectivity capabilities and Internet service. This estimate is for the first 3 months, but your Internet service payments will be ongoing to your service provider.

(22) We recommend that you have some additional funds for opening cash and expenses to cover entity formation costs, three months of operations, employee salaries (including yourself), supplies, administrative costs and funds of on-going inventory purchases for the first 3 months of operations. This estimate includes the Direct Deposit Fee of \$5 per month.

(23) Estimated charges for you to consult with independent professional advisors like a lawyer and CPA.

(24) The low estimate assumes you are in a facility or store where no account broker fee need be paid. The high estimate assumes you are in a location where an account broker fee must be paid. This fee is only paid if we pay a fee for the right to locate the Food Service Counter in the facility or store. You reimburse us for the amounts paid, not to exceed \$500 per quarter for each Food Service Counter subject to this fee.

(25) A new franchisee will not achieve the low estimate of zero in any category where zero is indicated, except possibly training fee for managers (if no managers are trained) additional uniforms (if no additional uniforms are purchased) and opening assistance (see footnotes 5, 18 and 13). The estimated range for a new franchisee is based on the low estimates from these footnotes, and a high that is the sum of the high estimates in each category.

(26) The initial investment for an additional location is similar to a new franchise, except an existing franchisee adding an additional location may possibly achieve a low estimate of zero in one or more categories. The estimated range for an existing franchisee adding an additional location assumes that the low estimate of zero will be achieved for: a) the credit and background check fee; b) tuberculosis, drug testing and criminal background checks; c) ServSafe® Food Protection Manager Training, Testing and Certification; d) ServSafe® Allergen Awareness Training and Testing; and, since there is no further initial training for you or your managers, e) training fees for you or your managers; and f) travel and living expenses during training for you or your personnel. Thus,

the total ranges are not simply the sum of the low or high estimates. Since some of the testing and certifications expire every two years, you may be required to complete c) and d). We may also require you to complete b).

**ESTIMATED INITIAL INVESTMENT FOR A SELF-SERVICE FOOD SERVICE COUNTER
LOCATED IN A GROCERY STORE OR OTHER LOCATION OWNED BY A THIRD PARTY(1)**

Item	Amount	Method of Payment	When Due	To Whom Paid
Opening Food Inventory (2)	\$1,625 - \$6,500	Cash before opening, or we can deduct from commissions we pay you.	Before opening or over time by deduction from commissions we pay to you.	AFC
Signage (3)	\$0 - \$500	Cash	Before opening	AFC
Coolers and Ice Packs (4)	\$0 - \$900	Cash	Before opening	Suppliers
Insurance (5)	\$500 - \$ 2,000	Cash	When incurred	Insurance company/AFC if we obtain the insurance on your behalf
Licenses & Permits (6)	\$300 - \$1,500	Cash or by deductions from commissions we pay you	Before or shortly after opening.	Government Agencies/ AFC if we assist in obtaining these for you
Additional Funds -3 months (7)	\$1,600 - \$9,000	As incurred	As incurred	employees, suppliers, utilities, AFC
Account Broker Fee (8)(first quarterly payment per location)	\$0 - \$500	Cash	When incurred.	AFC
Total for a self-service Food Service Counter	\$4,025- \$20,900			

Footnotes:

(1) This table provides estimates for a self-service Food Service Counter located inside a grocery store or similar location. We let you open a self-service Food Service Counter only if you already have an existing full-time or part-time Food Service Counter franchise. We do not charge an initial fee for you to enter into the Self-Service Location Addendum with us. This table estimates your initial investment from the period before your self-service Food Service Counter opens for business, until about 3 months of operations. We used our experience in operating and working with franchisees to make these estimates. These are only estimates. Unless indicated otherwise, all amounts payable are non-refundable. See item 10 for financing we provide.

(2) Estimated additional cost for opening food inventory. Food inventory is delivered to your full-time Food Service Counter for preparation. It is your responsibility to prepare the food and deliver it at least once daily to your self-service location.

(3) For a Food Service Counter in a grocery store, the store will usually purchase and own the display case(s), signage, storage racks and similar equipment. The high estimate of \$500 assumes you buy an optional decorative umbrella, sign or banner with words or slogans we approve.

(4) Estimated cost for you to purchase coolers and ice packs to allow you to transport the food products to your self-service location. The low estimate assumes you already own this equipment.

(5) Estimated one year premium for required insurance at your self-service location. Premium amounts may vary based on sales volume.

(6) Estimated costs for retail food license and business license which typically must be obtained from the City, County and/or State. At our election, we have the right, but no obligation, to obtain any required licenses and permits in your name. You grant us a power of attorney to apply for any required licenses, permits and any renewals of these for your Food Service Counter(s). You reimburse us for any costs and fees incurred by us in applying for these licenses and/or permits on your behalf.

(7) We recommend that you have some additional funds for opening cash and expenses to cover entity formation costs, three months of operation, employee salaries (including yourself), supplies, administrative costs and funds of on-going inventory purchases for the first 3 months of operations.

(8) The low estimate assumes you are in a facility or store where no account broker fee need be paid. The high estimate assumes you are in a location where an account broker fee must be paid.

ITEM 8 RESTRICTIONS ON SOURCES OF PRODUCTS AND SERVICES

Your Food Service Counter will be at a location you and we choose. It will be a grocery store or other location whose owner has an agreement with us or our parent for us to place a Food Service Counter there.

We develop some proprietary food products, sauces and spices. To protect our trade secrets and maintain quality control, we can require you to buy these proprietary items only from us or from suppliers we designate. Currently, we, our affiliates and our other approved suppliers are the only approved sources for seafood products, rice, vinegar, pre-prepared frozen salads, prepackaged condiments, prepackaged food items, other food products not including produce, utensils with our logo, and serving trays. Equipment like food preparation utensils (knives, rice scoopers) and plastic storage containers, can be purchased elsewhere provided they have been approved by the National Sanitation Foundation and bear the NSF logo. You must also comply with any source restrictions imposed by the facility owner to maintain quality control or an identifiable source for products in the event of product recalls.

We do not require you to buy or use electronic cash registers. All food purchases are normally handled through supermarket cash registers or the registers of the facility where your franchise is located. You are required to purchase a computer system with Internet connectivity to permit you to submit purchase orders online and to obtain information on new products, product specifications or other information.

We typically provide the initial inventory and equipment to the Food Service Counter before you arrive to start operating. As a result, you will obtain these items from us. This helps us get your Food Service Counter ready and lets you start operating sooner. You must keep all equipment in good repair.

We have a list of approved suppliers for food products and other items you need to operate the Food Service Counter. The list identifies manufacturers, brands, suppliers, transportation companies, and items and services we approve. We can revise the list from time to time. Other than our parent AFCC, our affiliate AFCDC and us, we do not have any suppliers in which any of our officers own an interest.

We have the sole right to develop new items for sale at your Food Service Counter. You must not develop, offer or sell sushi or other food items to the public without our prior written approval or sell any non-approved item from your Food Service Counter.

If you want to offer something we haven't approved, or buy from a supplier we haven't approved, you must tell us in writing and provide us samples and other information we need to check out the product or supplier. We expect to complete our review of a proposed new supplier within 60 days, however this could take longer depending on our and the supplier's availability, and the extent of inquiry needed. Our approval

may be conditioned on things like whether the supplier meets our standards, has a good reputation, has satisfactory financial condition, can provide service at a level we require, and is willing to agree to restrictions to protect our intellectual property rights. We can charge you or the supplier to investigate the supplier. Later, we can revoke any approval we've given. We permit franchisees to contract with suppliers who have been approved by us and who meet our criteria. We can issue written specifications and standards to franchisees and approved suppliers. We have the right to modify our specifications and standards on written notice.

You must purchase the insurance coverage we specify from carriers satisfactory to us, and containing terms we require. As of the effective date of this Disclosure Document, we require the following insurance:

(a) Commercial General Liability coverage covering the premises and your operations for bodily injury and property damage liability including contractual liability, personal injury and product liability coverage in amounts not less than \$1,000,000 per occurrence and \$2,000,000 aggregate;

(b) Worker's Compensation Insurance in statutory amounts as required in the state(s) where your operations are conducted, including a Voluntary Worker's Compensation endorsement extending coverage to all employees exempted from coverage due to numerical employment requirements of the state;

(c) Employer's Liability Insurance with limits of \$1,000,000 per occurrence;

(d) Unemployment Insurance covering your employees;

(e) Property Insurance in an amount adequate to replace contents in the event of an insured loss;

(f) Business Income Insurance with limits adequate to insure profits and continuing business expenses for one year;

(g) State disability insurance for your employees (as required by law); and

(h) Automobile liability insurance including coverage for autos owned, leased, hired or borrowed by you or your owners, with limits of at least five hundred thousand dollars (\$500,000) per occurrence of bodily injury and property damage combined, and any other or increased amounts of insurance that we may require from time to time for each vehicle used by you (whether principally or occasionally) in connection with the franchised business (for example, to drive to the franchised location(s), to deliver products to self service locations, or otherwise). See Franchise Agreement Section 12.1.

You must use only goods and services that comply with our standards. We don't have any other required specifications, designated suppliers or approved supplies. Except as disclosed in this Item, we do not currently have any arrangements to derive revenue from your purchases or leases from third parties. We could make such arrangements in the future.

We derive revenue from your purchases from us and/or our approved suppliers. The revenue equals the amount we charge you or the supplier for the items. Your purchases from us and/or our approved suppliers will be 85% or more of the purchases you will make to start the business; and nearly 95% or more of the purchases you will make on an ongoing basis to operate the business. The main item we expect that you will buy from others is produce. In the year ending March 31, 2025, the AFC franchise system generated approximately \$1.457 billion in gross receipts of which approximately \$694.7 million was revenue to AFC. From the revenue to AFC, approximately \$250.7million in the US was from required purchases by franchisees, which is 17.2% of the gross receipts and 36.1% of our total revenue. Because AFCDC does not make direct sales to franchisees, but rather sells to us and we then sell to franchisees, in the fiscal year ending March 2025, AFCDC did not derive revenue from required purchases by franchisees.

There aren't any purchase or distribution cooperatives and we do not negotiate terms from any suppliers to supply direct to franchisees. There are no material benefits to you based on buying from particular suppliers.

ITEM 9 FRANCHISEE'S OBLIGATIONS

This table lists your principal obligations under the franchise and other agreements. It will help you find more detailed information about your obligations in these agreements and in other items of this Disclosure Document.

Obligation	Sections In Agreement	Items In Disclosure Document
a. Site selection and acquisition/lease	Fran. Agmt. Secs. 1, 3.1-3.4 Full-Time/Part-Time/Self-Service Location Franchise Addendum Sec. A. Asset Purchase Agmt. Food Service Counter Transfer Agmt.	7, 8, 11, 17
b. Pre-opening purchases/ leases	Fran. Agmt. Secs. 11.5, 11.11, 11.12, 11.15, 11.18, 11.19, 11.20, 12.1 Full-Time Location Franchise Addendum Sec. D. Part Time/Self Service Location: Sec. C	5, 8
c. Site development and other pre-opening requirements	Fran. Agmt. Secs. 3.1-3.4	5, 8, 11, 12
d. Initial and ongoing training	Fran. Agmt. Secs. 11.26, 11.27, 11.28	11
e. Opening	Fran. Agmt. Secs. 2 Full-Time Location Franchise Addendum Sec. C. Part Time/Self Service Location Sec. B.	11
f. Fees	Fran. Agmt. Secs. 4.5, 9, 11.26-11.30, 13.2, 14.9; Full-Time Location Franchise Addendum Sec. B, E. Part Time/Self-Service Location Addendum: Sec. D	5, 6
g. Compliance with standards and policies/Operating Manual	Fran. Agmt. Secs. 1, 5, 6.1-6.7, 7.1-7.2, 11.1 - 11.28, 11.30 Full-Time Location Franchise Addendum Sec. F. Part Time/Self Service Location Addendum Sec. E.	11
h. Trademarks and proprietary information	Fran. Agmt. Secs. 4.1-4.5, 6.1-6.7, 16.9	13, 14
i. Restrictions on products/services offered	Fran. Agmt. Secs. 7.2, 11.1-11.25	16
j. Warranty and customer service requirements	Fran. Agmt. Secs. 9.2, 11.2, 11.6, 11.7, 11.22	11
k. Territorial development and sales quotas	Not Applicable	12
l. Ongoing product/service purchases	Fran. Agmt. Secs. 11.4-11.6, 11.8-11.13, 11.14, 11.15	8, 10
m. Maintenance, appearance, and remodeling requirements	Fran. Agmt. Secs. 7.1-7.2, 11.1-11.3	8, 17

Obligation	Sections In Agreement	Items In Disclosure Document
n. Insurance	Fran. Agmt. Secs. 12.1-12.5	7, 8
o. Advertising	Fran. Agmt. Sec. 8 and 9	11, 12
p. Indemnification	Fran. Agmt. Sec. 12.6 Asset Sale Agmt. Sec. 8.2 Food Service Counter Transfer Agmt. Sec. 5	6
q. Owner's participation/ management/staffing	Fran. Agmt. Sec. 11.17, 11.28 Full-Time Location Franchise Addendum: Sec. F. Part Time/Self-Service Location Franchise Addendum Sec. E	15
r. Records/reports	Fran. Agmt. Secs. 10.1-10.4, 11.1	6
s. Inspections/audits	Fran. Agmt. Secs. 4.5, 10.4	6
t. Transfer	Fran. Agmt. Secs. 14	6,17
u. Renewal	Fran. Agmt. Sec. 13	17
v. Post-termination obligations	Fran. Agmt. Secs. 15.6-15.7 Full-Time Location Franchise Addendum Sec. G.3-G.6 Part Time/Self Service Location Addendum: Sec. F.3-F.6	17
w. Non-competition covenants	Fran. Agmt. Secs. 6.3-6.7	17
x. Dispute resolution	Fran. Agmt. Sec. 16.8 General Release Sec. 9 Asset Sale and Purchase Agmt. Sec. 10.3 Food Service Counter Transfer Agmt. Sec. 10.	17
y. Risk Management	Fran. Agmt. Secs. 12.1-12.6	6
z. Nature of Business	Fran. Agmt. Sec. 12.7	1
aa. Restriction on Communication	Fran. Agmt. Sec. 16.5	15
bb. Personal Guaranty	Signature Page of Franchise Agreement, Full-Time/Part-Time/Self-Service Location Franchise Addendum	5, 6
cc. Tuberculosis, Drug Testing and Criminal Background Checks	Franchise Agmt. Sec. 11.30	5, 6, 7
dd. Cross Default	Franchise Agmt. Sec. 15.3 Full- Time Location Franchise Addendum Sec. G.2 Part Time/Self-Service Location Addendum: Sec. F.2	17

ITEM 10 FINANCING

We can finance certain expenses you incur in operating your Food Service Counter, at our discretion, in circumstances when the commission payable to you is less than the balance owed to us. You can pay us over a period of months by deductions from commissions we pay you. We do not offer other direct or indirect financing. We do not finance any debt to a third party. We do not guarantee your note, lease or obligation.

Summary of Financing Offered

Item Financed (Source)	Amount Financed	Down Payment	Term (MOS) (1)	APR%	Monthly Payment (1)	Prepay Penalty	Security Required (2)	Liability on Default	Loss of Legal Right on Default
Initial Inventory Purchase	\$10,400-\$31,200	None required	3-6(1)	No interest	Varies(1)	None	None	Individual liability	Not applicable
Ongoing Inventory	\$6,500 - \$23,400	None required	3-6(1)	No interest	Varies(1)	None	None	Individual liability	Not applicable
Opening Assistance	Up to \$1,800	None required	3-6(1)	No interest	Varies(1)	None	None	Individual liability	Not applicable
Labeling Machine and Warranty	Up to \$1,699	None required	3-6(1)	No interest	Varies(1)	None	None	Individual liability	Not applicable
Equipment and Small Wares	\$14,700-\$46,000	None required	3-6(1)	No interest	Varies(1)	None	None	Individual liability	Not applicable
Purchase Price Financing of Existing Location(3)	\$0 - \$50,000	Varies, but usually equals first installment due	0-12 months	No interest	Varies(3)	None	None(3)	Individual liability	Not applicable

Footnotes:

- (1) We may lump all expenses together. Our accounting manager makes a determination regarding the term of the financing and monthly payment, which is then deducted from commissions we pay you. The range financed will depend on which items are financed and ratio between store sales and amount owed. A shorter term would increase the monthly deduction.
- (2) We self-finance the above purchases. We do not require any security interest to obtain financing. Except when purchasing an existing location, you do not sign a promissory note, so there is no waiver of defenses. We do not have any practice or intent to sell, assign or discount the financing arrangements to any third party. We do not arrange financing from other sources and we do not guarantee your obligations to third parties.
- (3) If you purchase an existing business from us and ask us to finance part of your purchase price, you will sign a promissory note. If you fail to make payments, we can deduct payments from commissions due to you.

The Promissory Note provides a late payment penalty of the lower of 1% per month or highest rate allowed by law of the amount overdue and acceleration of the entire amount due if you are more than 10 days late making a payment. If you don't comply with the Promissory Note or any of the other agreements with us we can accelerate the entire amount remaining due without notice.

You waive all rights to presentment, protest and demand, diligence in collection and notice of protest, presentment, demand, dishonor and nonpayment of the Promissory Note and any release or discharge arising from any extension of time, discharge of any party liable for payment of the Promissory Note, or other cause of release or discharge other than actual payment in full of the Promissory Note.

We don't have any intent to sell, assign or discount to a third party all or part of the Promissory Note; however, we reserve the right to do so.

ITEM 11 FRANCHISOR'S ASSISTANCE, ADVERTISING, COMPUTER SYSTEMS AND TRAINING

Except as listed below, AFC is not required to provide you any assistance.

Pre-Opening Services. Before you open your Food Service Counter for business, we will provide you the following services:

1. We will provide you (or your principal owners) training described in the tables, below, unless you already received our training. The training provided will depend on the type of Food Service Counter you will operate--sushi, steam table or a combination of both and whether you already have food safety certification. We may exempt you from some or all of our training sessions if we determine, at our sole discretion, that you are already experienced in these subjects. You (or your principal owners) must complete this training to our satisfaction before starting operations. If you (or your principal owners) fail to complete training to our satisfaction, we may cancel the franchise agreement and keep all amounts paid to us. We may also exempt you from some or all training (at our sole discretion) if you or your affiliate currently owns or operates a Food Service Counter or the Franchise Agreement is executed as a renewal Franchise Agreement (Fran. Agmt Sec. 11.26).

TRAINING PROGRAM
Sushi Bar Training Table (if applicable to your Franchise) ^{1,2,3}

Subject	Hours of Classroom Training	Hours of on the Job Training	Location
Introduction, Legal Compliance and Label Machine Instruction	4 Hours	Not Applicable	Our corporate headquarters, online or other location we choose.
Sanitation and GMP	8 Hours	Not Applicable	Our corporate headquarters, online or other location we choose.
Sushi and Other Food Preparation and Evaluation	Not Applicable	48 Hours	Our corporate headquarters, online and/or at a company owned and operated Food Service Counter that we select, or other location we choose.
Sushi Related Products, Product Demonstration and Sampling Programs	4 Hours	4 Hours	Our corporate headquarters, online and/or at a company owned and operated Food Service Counter that we select, or other location we choose.
Franchise Management ⁴	16 Hours	Not Applicable	Our corporate headquarters, online or other location we choose.
TOTALS	32 Hours	52 Hours	

- (1) The sushi bar training course takes 10 days. This training is provided where the primary food offering is sushi and onsite cooking is not required.
- (2) We will offer the training program weekly or as needed.
- (3) We use the following Instructional Materials: Standard Operating Manual, Standard Sanitation Operating Procedure and Methods Manual and recipe guides applicable to your franchise.
- (4) Franchise Management includes basic accounting, operations, business insurance, inventory control, employee management, marketing, license and permitting requirements.

TRAINING PROGRAM
Steam Table Training Table (if applicable to your Franchise) ^{1,2,3}

Subject	Hours of Classroom Training	Hours of on the Job Training	Location
Kitchen Equipment, Sanitation and GMP	Not Applicable	6 Hours	Our corporate headquarters, online and/or at a company owned and operated Food Service Counter that we select, or other location we choose
Kitchen Set-Up and Ingredient and Material Preparation	Not Applicable	14 Hours	Our corporate headquarters, online and/or at a company owned and operated Food Service Counter that we select, or other location we choose
Steam Table Menu, Product Cooking and Evaluation	Not Applicable	44 Hours	Our corporate headquarters, online and/or at a company owned and operated Food Service Counter that we select, or other location we choose.
Demonstration and Sampling Programs	Not Applicable	4 Hours	Our corporate headquarters, online and/or at a company owned and operated Food Service Counter that we select, or other location we choose.
Franchise Management⁴	4 Hours	Not Applicable	Our corporate headquarters, online or other location we choose.
TOTALS	4 Hours	68 Hours	

- (1) The steam table training course takes 9 days. This training is provided where onsite cooking is offered.
- (2) We will offer the training program as needed.
- (3) We use the following Instructional Materials: Standard Operating Manual, Standard Sanitation Operating Procedure and Methods Manual, Steam Table Operating Manual and recipe guides applicable to your franchise.
- (4) Franchise Management includes basic accounting, operations, business insurance, inventory control, employee management, marketing, license and permitting requirements.

TRAINING PROGRAM
Food Protection Manager Certification Training

Subject	Hours of Classroom Training	Hours of on the Job Training	Location
ServSafe® Food Protection Manager Certification ^{1,2,3,4}	12 Hours	Not Applicable	Our corporate headquarters, online or other location we choose.
Allergen Awareness Training ⁵	1 - 3 Hours	Not Applicable	Online
TOTAL	13 -15 Hours		

- (1) You must enroll in the ServSafe® Food Protection Manager Certification program we offer and pass the certification exam before starting operations. ServSafe® Food Protection Manager Certification training takes 2 days.
- (2) We will offer the training program weekly or as needed.
- (3) The instructions material used is ServSafe® Essentials.
- (4) Every Food Service Counter must have one ServSafe® Food Protection Manager Certified person onsite during all operating hours.
- (5) You must enroll in the ServSafe® Allergen Awareness Training offered online by ServSafe® and pass the training exam before starting operations. ServSafe® Allergen Awareness Training takes 1-3 hours. We require proof that you completed the training and passed the exam prior to the last day of orientation training.

We charge \$1,000 for the sushi training, \$1,300 for the steam table training and up to \$275 per person for the ServSafe® Manager Examination and Certification. If we exempt you from all training, we will waive the training fee. You pay your own travel and living expenses during training. Classroom training is at our corporate headquarters in Torrance, California, online or other location we choose. We reserve the right to waive the training requirement in our absolute discretion where we are satisfied that you have sufficient skill, knowledge and experience with both the operational requirements and our prescribed and preferred procedures. On the job training is partly at a kitchen at our corporate headquarters and partly at a company owned and operated Food Service Counter that we select.

Our trainers are various individuals who work in various departments such as accounting, operations, marketing and compliance. Each individual provides instruction on the area of his or her experience. At the issuance date of this Disclosure Document these included: Gerardo Siordia Posada, who has 6 years' experience with us, is our Director of Corporate Training; Mike Hong, who has 9 years' experience with us, is our business development and product promotion and customer service instructor; San Yu, who has 6 years' experience with us, is our business development and product promotion and customer service instructor; Peter Han who has 29 years' experience with us, is our food preparation instructor; Aung Thu who has 9 years' experience with us, is our food preparation instructor; Ye Tun, who has 9 years' experience with us, is our franchise labeling equipment instructor; Tai-li Wang who has 12 years' experience with us, is our franchise documentation instructor; and Ben Wu, who has 8 years' experience with us, is our Hot Food Senior Manager.

To help compare the store's reported sales and reduce or avoid discrepancies, during training we instruct you on keeping a log of your sales; and comparing your log to the sales reports we send you, which are based on information reported to us by the facility owner. If there is a discrepancy, you must tell us within 30 days. We can then contact the facility owner to alert them and attempt to reconcile the discrepancy. (Fran. Agmt § 10.3).

2. We will identify a grocery store or other venue where your Food Service Counter will be located and we will have worked with them on the build-out of the Food Service Counter. (Fran. Agmt. Sec. 3.1). Locations are established based on our parent's or our written agreement with a grocery store chain or venue owner, to place Food Service Counters at their locations. We are not required to show you the agreement. Our agreement with the facility owner may be month-to-month and can be terminated by the facility owner on short notice. We consult with you on which of the available locations to assign to you before you sign the franchise agreement. If you purchase an existing location from us or our parent, we will charge you our estimate of the fair market value of the Food Service Counter, taking into account the revenue, assets, equipment and value of the established market of the Food Service Counter sold to you.

You must select a location before signing the franchise agreement. If you and we cannot agree on a location, then we will not enter into the franchise agreement. You are responsible to obtain all required licenses and permits to operate your location and to hire and train employees. You must provide copies of your licenses and permits to us. If the facility owner, due to labor contracts or otherwise, requires your Food Service Counter(s) employees to be employed directly by the facility owner, and we are asked to reimburse the facility owner for these employment costs, we will then deduct such payments from the amounts due to you under your Franchise Agreement. We can assist you obtain health permits on request. We will train those employees you select at our then standard rates.

3. We will loan you a copy of our Confidential Operating Manual, SSOP Manual and Steam Table Operating Manual (if applicable to your franchise). (Fran. Agmt. Sec. 5.1.). The table of contents of our operating manuals are Exhibit L to this Disclosure Document. As of March 2025 our Standard Operating Manual contained a total of 163 pages, our Standard Sanitation Operating Procedure and Methods Manual had a total of 29 pages, our Steam Table Manual had a total of 21 pages, our Sushi Recipe Guide had 125 pages, our Steam Table Recipe Guide had 62 pages and our Wild Blue Recipe Guide had 162 pages.

4. You must purchase from us and/or our approved suppliers any required equipment, signs, fixtures, opening inventory and supplies not provided by the owner of the facility where you will operate. We will provide written specifications to you about these requirements on written request. You are responsible to install these items, unless the installation will be done by the facility owner. We will deliver initial inventory and equipment to the Food Service Counter. You pay us for these. (Part Time and Self-Service Fran. Addendums Sec. C; Full Time Fran. Addendum Sec. D). You must keep all equipment, signs and fixtures in good repair.

If we agree to grant you a franchise, then typically you will start operating your Food Service Counter within 3-10 days after you complete training. The main factors to this timing are whether the location is already built out by the facility owner, equipped and ready to operate, time for you to return to where the franchise will be located, and your desire and readiness to start. If there is a delay by the facility owner in building the location, or delay by you and us in choosing a location, it could be 30-60 days or longer before you start operating the Food Service Counter.

Post-Opening Services. After your Food Service Counter opens, we will provide you the following services:

1. For your first location only, we will send our regional manager or other employee to assist you at your location for up to three days. If you ask, or we decide that additional on-site training is needed, we'll charge you \$450 per additional day. Our decision will be based on our evaluation of your need for additional assistance. We decide in consultation with you. (Fran. Agmt. Sec. 11.27.)

We will provide ongoing research and development seeking to identify new products that you may sell at your Food Service Counter. (Fran. Agmt. Sec. 11.6.) We will tell you about identified new products that you must offer or sell.

2. We will identify suggested and approved suppliers for products you will use in your Food Service Counter(s). For some items we may be the only approved supplier. We plan to identify any approved supplier in writing. (Fran. Agmt. Sec. 11.10)

3. We (or independent third party inspectors) will periodically inspect your Food Service Counter(s) and tell you of operations we think you need to address or improve. (Fran. Agmt. Secs. 4.5, 11.2)

4. We may periodically provide additional training on new products or operation. We can require you and your manager to attend. We can charge you our current training fees for each person for whom we provide such additional training. You are responsible for all travel and living expenses incurred to attend any training programs. (Fran. Agmt. Sec. 11.28.)

5. We may recommend resale prices or pricing schedules to you and may provide pricing labels conforming to these recommendations. You have the right to determine prices that you charge for products sold from your Food Service Counter(s). If you want to charge a price or prices that differ from a price or price schedule recommended by us, then you must pay or reimburse any additional reasonable costs that we incur to prepare price labels containing the pricing determined by you. When allowed by law, we can specify maximum and minimum prices for products sold at your Food Service Counter. (Fran. Agmt. Sec. 11.25.)

If you must stop operating at a location because the owner of the location no longer wants a Food Service Counter there, or objects to you as the operator there, without your fault, we will try to find another location in the area for you to relocate to. There could be delay in getting another location, relocation may not be possible before expiration of the term of your agreement, or at all and your new location may not be comparable to the old. Additionally, any relocation, will involve a substantial interruption in operating your Food Service Counter until a new location is identified and prepared. You do not have to pay another franchise fee but you could lose expenses incurred from the original location. Conditions and results of the new location may differ from the prior location. If we cannot get a new location there is still no refund of any fees. (Fran. Agmt. Sec. 3.2).

If you ask, we will give you a list of our franchises in an area to help you comply with the restriction on competing that continues in effect after you are no longer our franchisee. (Fran. Agmt. Sec. 6.4(E)). On request, we will also assist you with any operational problems you encounter.

Advertising

We encourage you to advertise your Food Service Counter. You must submit proposed advertising to us and use the materials only after you get our consent. You can't use any materials without first getting our written consent. We can restrict where you can advertise and how you advertise. You may not advertise on the Internet or use other electronic media without obtaining our prior written consent. Your advertising must include trademark, copyright and independent ownership notices that we request. (Fran. Agmt. Sec. 8.1 and 8.2). There is no franchisor sponsored or operated franchise advertising program or fund at this time. We have no obligation to spend any amount on advertising in the area or territory where your Food Service Counter is located.

We can designate a geographic area as an advertising cooperative that you must participate in. You'll participate and contribute to the cooperative according to its procedures. We can set the amount you and other franchisees contribute to any advertising fund operated by the cooperative. There is no requirement for franchisor owned outlets to contribute to the fund, although we anticipate that they will do so according to guidelines we establish. The cooperative will operate according to governing documents that we prepare or consent to. (Fran. Agmt. Sec. 8.4). If and when formed, these will be available to you for review. We can decide who administers the cooperative. There are no current requirements for cooperatives to prepare

financial statements. We have the power to form, change, dissolve or merge cooperatives, at our discretion. (Fran. Agmt Sec. 8.4).

There are no current advertising councils composed of franchisees that advise us on advertising policies.

We can conduct regional or national advertising campaigns, geotargeted marketing campaigns, or national news and weather campaigns (the “Advertising Campaigns”). We can bill you your pro-rata share of such advertising. We may absorb some of the cost for such advertising, but are not obligated to do so. We undertake no obligation, in administering such Advertising Campaigns, to make expenditures for your Food Service Counter(s) that are equivalent or proportionate to your contribution, or to ensure that any particular franchisee benefits directly or pro rata from marketing or promotion conducted with the Advertising Campaigns. Food Service Counters operated by us or our affiliates may, but are not required to, contribute to the Advertising Campaigns. If they do, they may not be required to contribute in the same percentage as you and may stop contributing at any time without notice to you. We will prepare an annual unaudited accounting of the expenditures of the Advertising Campaigns which will be provided to you upon your written request. (Fran. Agmt. Sec. 8.6 and 9.18).

Computer Equipment and Registers

We do not require you to buy or use electronic cash registers. All food purchases are normally handled through supermarket cash registers or the registers of the facility where your franchise is located.

We require you to purchase a computer system with Internet connectivity to permit you to submit purchase orders online and to obtain information on new products, product specifications and other information from us. We do not have specific brand or other computer system specifications. We estimate the cost of purchasing a computer system with Internet capabilities is about \$600. You are solely responsible for your computer system, including maintaining and repairing it when necessary. The Franchise Agreement does not impose any obligation on you to purchase maintenance, update, upgrade or support contracts for your computer system. We do not currently require you to provide us independent access to the information generated or stored on your computer system, but may require you to do so in the future on written notice. We do not impose any upgrade or update obligations for your computer, but you must keep your computer current. You are also required to obtain and provide us an email address to which we may send written communications and sales reports pertaining to your location(s).

We require you to purchase a Samsung Tablet (Galaxy Tab E or A), Dongle and printer (“Tablet System”) meeting our specifications (See Exhibit “Q”) to enable you to print labels for your products. We estimate the cost of purchasing the Tablet System and warranty will range between \$900 and \$1,699. You must also pay the monthly web and data fee (currently up to \$100 per month) for each Food Service Counter you operate. You are solely responsible for your Tablet System, including maintaining and repairing it when necessary. The Franchise Agreement does not impose any obligation on you to purchase maintenance, update, upgrade or support contracts for your Tablet. We can require you to provide us independent access to the information generated or stored on your tablet, including inventory tracking logs. You must keep the Tablet System current. We can require you to upgrade or update the Tablet System. We may, in the future, develop or designate computer application software for use with the Tablet System for performing various functions for your Food Service Counter(s). You must purchase, implement and use the software in operating the Food Service Counter(s) and comply with all standards we prescribe regarding the software, including upgrade and maintenance requirements.

ITEM 12 TERRITORY

We grant you a franchise for one or more specific location(s) in grocery stores or other venues. These

locations will be specified in one or more franchise addendums. You do not receive any minimum territory. If on signing the franchise agreement or thereafter we agree that you may operate more than one location, you will sign our then current location addendum for each additional location to be opened and pay the applicable fee. We assess whether to grant you the right to operate another location, based on the following factors: availability of another location; the additional location is in a non-competing store; the new location is relatively near your existing location(s); in our judgment, you are financially able to operate multiple locations; in our judgment you are capable of operating and managing another franchise location; and you have qualified managers to assist you operate multiple locations. Our form location addendums are attached as Exhibits D through F.

You will not receive an exclusive territory. You may face competition from other franchisees, from outlets that we own, or from other channels of distribution or competitive brands that we control. We can grant franchises or licenses to others to operate Food Service Counters anywhere, regardless of how close they are to your Food Service Counter(s). We can sell products and other items to anyone and anywhere (even in the facilities where you operate), including, but not limited to, pre-packaged products and central kitchen products identified by our marks or other marks, whether or not such marks are authorized for your use, as well as other products or services under the marks and other trademarks and service marks. We may also sell and distribute products through different distribution channels, such as via the Internet, telemarketing, catalog sales, other direct marketing sales and other means. We are not required to compensate you for any sales we make through these methods. You can operate only at your grocery store (or other type of facility) location and you must comply with the store's (or other type of facility's) rules, policies and guidelines. If required by the facility owner, you must sign any code of conduct or equivalent document required by the facility owner.

Our affiliates, JFE, BSFI, and Bento USA grant franchises or licenses to others to operate businesses similar to our Food Service Counters in the United States. There is no territorial restriction on their operations and they can compete with you even in the same facility where you operate.

Other franchisees and we can solicit and advertise anywhere, including in the area where your Food Service Counter is located.

We can impose geographic and/or other restrictions on advertising that you conduct or propose to conduct.

You must only sell products to end customers who are physically present at your Food Service Counter(s). You may not engage in the resale of any product or supply at wholesale, retail or through other means without our written consent. You are not permitted to sell any product using other channels of distribution (such as the Internet, catalog sales or telemarketing).

If the location where you operate closes or objects to you operating there or otherwise becomes unavailable without your fault, we will try to help arrange for you to operate a Food Service Counter at another location in the same general area. There is no assurance we will be able to do so. The facility you relocate to may be month-to-month and can be terminated by the facility owner on short notice. You release us from any loss of right or consent to operate at the location and agree not to hold us liable for any such event occurring during or after the term of the agreement.

Unless you sign an additional location addendum, you do not get any right to acquire additional Food Service Counters. If we are satisfied with how you operate your initial Food Service Counter, we can agree to add one or more locations to your existing franchise agreement. See our location addendums attached as Exhibits D through F.



We can grant franchises to others using our trademarks and system, at any location. We can also sell through company owned outlets.

Other than JFE, BSFI, BNI, and Bento USA neither we nor our affiliates have any current plans to operate or franchise a business under a different trademark that sells goods or services similar to those to be sold at your Food Service Counter, but reserve the right to do so.



ITEM 13 TRADEMARKS

We let you use the logo that includes the words Zenshi, AFC, or Wild Blue, as applicable to your franchise. The logos are on the cover of this Disclosure Document. We also claim rights in the trade dress used in our display cases.

We own the following trademark registrations on the Principal Register of the U.S. Trademark Office which we let you use:

Mark	Reg. No.	Goods/ Services	Registration Date
AFC FRANCHISE CORP.	4,163,336	Rice	June 26, 2012 (Renewed: November 29, 2021)
	4,166,625	Rice	July 3, 2012 (Renewed: November 30, 2021)
	6,172,908	Restaurant services; Restaurant and café services; Restaurant and catering services; Fast-food restaurant services; Take-out restaurant services; Sushi; combination meals consisting primarily of prepared pasta and rice specially prepared in an Asian style; Combination meals consisting primarily of meat, poultry, seafood and vegetables specially prepared in an Asian style.	October 13, 2020
WILD BLUE	6,172,901	Restaurant services; Restaurant and café services; Restaurant and catering services; Fast-food restaurant services; Take-out restaurant services	October 13, 2020

Our corporate parent, AFCC obtained the following trademark registrations on the Principal Register of the U.S. Trademark Office which we let you use:

Mark	Reg. No.	Goods/ Services	Registration Date
SOUTHERN TSUNAMI	2,782,535	Sushi and related products, namely, bottled sauces, seasonings, pickled ginger, wasabi, rice and tea.	November 11, 2003 (Renewed: November 2, 2013 and June 7, 2023)
	2,780,243	Sushi and related products, namely, bottled sauces, seasonings, pickled ginger, prepared wasabi, rice and tea.	November 4, 2003 (Renewed: November 2, 2013 and June 7, 2023)
HYBRID SUSHI	4,277,991	Sushi and related products, namely, bottled sauces, seasonings, pickled ginger, prepared wasabi, rice and tea.	January 22, 2013 (Renewed: March 27, 2023)
	4,277,992	Sushi and related products, namely, bottled sauces, seasonings, pickled ginger, prepared wasabi, rice and tea.	January 22, 2013 (Renewed: April 3, 2023)

Our corporate parent, AFCC has applied to register the following trademark on the Principal Register of the U.S. Trademark Office which we let you use:

Mark	Serial No.	Goods/ Services	Application Date
ZENSHI	97/806,598	Prepared, packaged and ready to eat Asian and Asian inspired meals, entrees, appetizers and beverages consisting primarily of beef, fish, seafood, poultry, pork, vegetables, and dairy, including sushi, sashimi and raw seafood, for consumption off the premises; retail and wholesale store advertising, management and administration services, including franchise system services, operation, sales and administration, for Asian and Asian	February 22, 2023

Mark	Serial No.	Goods/ Services	Application Date
		inspired fish, sea food, sushi, sashimi, beef, chicken, pork, vegetables, miso, rice, pasta, noodles, beverages, carbonated drinks, fruit juices, teas, and processed foods; retail packaging, arranging and delivering of goods and/or assortments of goods, namely, prepared and prepackaged Asian and Asian inspired meals, entrees, appetizers and beverages, including, fish, seafood, sushi, sashimi, beef, poultry, pork, vegetables, miso, rice, pasta, noodles, carbonated drinks, fruit juices, teas, and processed foods; retail and wholesale food preparation services for immediate consumption that features Asian and Asian inspired meals, entrees, appetizers, and beverages, including, fish, seafood, sushi, sashimi, beef, poultry, pork, vegetables, miso, rice, pasta, noodles, carbonated drinks, fruit juices, teas, and processed foods.	

The trademark in the table immediately above is not yet registered. Therefore, this trademark does not have as many legal benefits and rights as a federally registered trademark would have. If our right to use the trademark is challenged, you may have to change to an alternative trademark, which may increase your expenses.

You may only use the trademarks associated with the franchise concept you operate. We claim common law rights to all trade and service marks we license to you.

As of the issuance date of this Disclosure Document, we either filed or planned to file all required affidavits to maintain these registrations.

We use the trademark AFC. Some other food companies and restaurant franchise systems also use the initials AFC or logos that include these letters. We have found that some started before us, and some started after. The other uses of “AFC” include franchising or on food products. AFC is also used as a trademark for

many other goods and services having nothing to do with food or restaurants. Because our parent and we have used “AFC” continuously since at least 1989 without any known instance of confusion, we believe the marketplace has shown there is no material issue or risk of infringement or confusion.

We have a license from AFCC that lets us use and franchise you to use the marks “Zenshi,” “Southern Tsunami,” and “Hybrid Sushi” . The agreement does not have a specific term; however, AFCC can terminate the license at any time. Termination forces us to stop granting new franchises under these brands, but does not affect franchises granted before termination. Because AFCC is our owner we do not expect the agreement to be terminated at any time that would be disruptive to us. Other than AFCC’s right to terminate the license agreement as stated above, no agreement limits our right to use or license the use of the marks that are material to the franchise.

There are no currently effective material determinations of the Patent and Trademark Office, Trademark Trial and Appeal Board, trademark administrator of any state or any court regarding our principal trademarks. In some locations, your use of our trademarks will be limited by our agreement with the store.

You must tell us in writing if someone claims you are infringing a trademark, if you find out anyone else may be infringing our trademarks or claims rights to our marks or to a confusingly similar mark.

If you used our trademarks according to the Franchise Agreement, then we’ll do what we think is appropriate to defend and indemnify you against someone else’s claim that you infringed. We can defend or settle the claim using counsel we choose. You must cooperate with us. If someone else is infringing, then we will decide what we want to do about it. You can’t make any claim on them. We have the right to control all administrative proceedings or litigation involving our marks.

If we say so, you must change or stop using our marks, or switch to a different mark, or use different marks. You must use the marks in the way we say to. We don’t have to pay your expenses and you can’t make any claim against us for changing or stopping your use of the marks.

ITEM 14 PATENTS, COPYRIGHTS AND PROPRIETARY INFORMATION

No patents are material to the franchise. You will learn information that we consider confidential and trade secret. This includes recipes, operating procedures and contents of training, and information on how we operate. The Franchise Agreement has provisions requiring you to keep all of this confidential.

We claim copyrights in our Standard Sanitation Operating Procedure and Methods Manual, Steam Table Manual and other written materials we provide to you. You will receive one set of manuals for each location you operate, except, no manuals are provided for self-service locations and the Steam Table Manual is only provided to locations with an operating steam table. You must return the manuals and other confidential information to us when your franchise agreement ends. (Fran. Agmt. Sec. 5.2.) When you return the manuals within 30 days of expiration or termination of the franchise agreement or an applicable addendum, we will refund to you the manual lease fees you paid (Fran. Agmt. Sec. 5.1).

There are no current determinations by the U.S. Copyright Office or any court regarding the copyright(s). We are not aware of any infringement of our copyrights.

You must tell us in writing if someone claims you are infringing our copyright(s), or if you find out anyone else may be infringing the copyright(s). The agreement does not specifically require us to defend and indemnify you against claims of copyright infringement. However, as our policy, if you use the manuals and other copyrights according to the Franchise Agreement, then we’ll generally do what we think is appropriate to defend and indemnify you against someone else’s claim that you infringed. If we choose to provide a defense, we will defend or settle the claim using counsel we choose. You must cooperate with us. If someone else is infringing, then we will decide what we want to do about it. You can’t make any claim on them. We have the right to control all litigation involving our copyrights.

If we say so, you must stop using our copyrights, or use other copyrighted works we prepare. You must use our copyrights in the way we say to. We don't have to pay your expenses and you can't make any claim against us for changing or stopping use of the subject matter covered by our copyrights.

We also claim proprietary rights in our product recipes, methods of product preparation and operating procedures (Fran. Agmt. Sec. 6.1.) You must keep our secrets confidential while you are a franchisee and afterward, and you must not make any copies of them. You cannot use our secrets in any activity other than operating your franchise. You must use reasonable procedures that we request to help protect our secrets. (Fran. Agmt. Sec. 6.2.)

ITEM 15 OBLIGATION TO PARTICIPATE IN THE ACTUAL OPERATION OF THE FRANCHISE BUSINESS

For a full-time location, you or your principal owner (if you are an entity) must either directly or through a manager, devote your full time to managing the Food Service Counter and your employees.

For a part-time location, you or your principal owner (if you are an entity) must either directly or through a manager operate the Food Service Counter on a part-time basis each day that the location where the Food Service Counter is located is open for business. As a part-time Food Service Counter, you are not required to be personally present or have a manager personally present at the Food Service Counter more than four hours per day.

For a self-service location, to assure food safety compliance, you must perform all food preparation only at your already existing full-time or part-time Food Service Counter. To promote a consistent customer experience, the self-service Food Service Counter must be inspected and the display case restocked at least once daily with sufficient amount of sushi and/or other food products before trading hours each day as directed by the facility owner. We can revise these requirements.

If a location is operated by a manager, you are still required to be personally and actively involved in operations and remain fully responsible for each location including supervising your employees.

If you operate more than one location, then at least one trained employee with ServSafe Manager Certification must act as manager under your supervision for those other locations. To assure we are aware of whom to contact at the location in the event of your absence, you must provide to us a written list of every manager you employ. You must update and provide a revised manager list to us in writing within 24 hours of any new manager being hired and any manager leaving your employment. You must abide by lawful requests of the business owner or manager of the premises regarding any employee or prospective employee. To protect the franchise system, before hiring a manager, you must require the manager to sign a confidentiality and non-disclosure agreement in a form satisfactory to us requiring the manager to protect our trade secrets and any other item we specify in writing from time to time. You must also provide adequate training to the manager before start of employment. There is no requirement for the manager to own any equity interest in you (if you are an entity, such as a corporation or limited liability company).

Your Food Service Counter(s) must be staffed by a sushi chef (if applicable to your location) before and during what we consider to be peak hours. To promote a consistent customer experience with the franchise system, you must also ensure that each Food Service Counter you operate is adequately staffed and that your display cases are adequately stocked during business hours.

You must not interfere with our relationship with the store where you are located. You must at all times act professionally and respectfully in dealing with customers, clients, the facility's personnel and our employees.

If you are an entity, we can require each of your owners and officers to sign a guaranty (the last pages of the Franchise Agreement and Location Addendums) in which he/she/they assume and agree to discharge all obligations of the “Franchisee” under the Agreements. In certain states we may require you to enter into your Franchise Agreement as an entity.

ITEM 16 RESTRICTIONS ON WHAT THE FRANCHISEE MAY SELL

You must offer and sell only items that we approve for sale at your Food Service Counter(s). If you want to offer other items, you must first get our written consent. We don’t have to consent.

You must offer the full range of menu items that we designate. If you wish to remove any item from your menu, you must first get our approval in writing. We can add additional items to the menu from time to time and remove items from our menu. There is no limit on our right to make changes. We have the sole right to develop new items for sale at your Food Service Counter(s). You must not develop, offer or sell any non-approved item from your Food Service Counter(s).

You are not restricted with regard to customers you may sell products to. However, you must conduct your business only from the grocery store or other location where you are located. We can restrict where and how you advertise.

You must only sell products to customers who are physically present at your Zenshi Counter(s)/AFC Food Service Counter(s)/Wild Blue Location(s). You must not engage in the resale of any product or supply at wholesale, retail or through other means without our written consent. You may not use any other channels of distribution such as the Internet, catalog sales or telemarketing to conduct sales.

ITEM 17 RENEWAL, TERMINATION, TRANSFER AND DISPUTE RESOLUTION

THE FRANCHISE RELATIONSHIP

This table lists certain important provisions of the franchise and related agreements. You should read these provisions in the agreements attached to this Disclosure Document.

Provision	Sections In Franchise Agreement	Summary
a. Length of Franchise Term	Franchise Agmt. Section 2 Part-Time/Self-Service Location Franchise Addendums Section B Full Time Location Franchise Addendum Section C	Term of your agreement with us is five years. It could end earlier if the store or facility where you are located ends their agreement that permits our franchise to be there. If not terminated earlier, and if you meet all conditions, the term is renewable for an additional five years.
b. Renewal or extension of the term	Franchise Agmt. Sections 13.1-13.3	If you meet conditions, you can renew for an additional 5 years, as we determine. This is subject to our agreement with the store or facility owner where you are located.
c. Requirements for you to renew or extend	Franchise Agmt. Sections 13.1-13.3	Conditions to renew for an additional term are: (a) compliance with all agreements with us; (b) ability to keep all your location(s); (c) provide 180 to 360 days written notice of desire to renew; (d) sign our then current form of Agreement and applicable addendums at

Provision	Sections In Franchise Agreement	Summary
		<p>least 30 days before the expiration date; (e) compliance with our then current qualifications and training; (f) bring Food Service Counter(s) into updated full compliance; and (g) pay our then current initial fee for each location you operate.</p> <p>You may be asked to sign agreements that contain materially different terms and conditions than your current agreements.</p>
d. Termination by you	Franchise Agmt. Section 2	You can apply to us to terminate the Franchise Agreement early if you want, effective 90 days after written notice, or any earlier time that we agree in writing. We will accept or reject your request to terminate early within 30 days of your written request. If we fail to respond within the 30 day period, your request to terminate early will be deemed rejected (subject to state law).
e. Termination by us without cause	Franchise Agmt. Section 3.3 Self-Service Addendum Section F.1	<p>We cannot terminate without cause, except that we can terminate any time if the facility where you are located ends their agreement with us.</p> <p>We can terminate the self-service addendum at any time, for any reason or no reason on 30 days written notice to you.</p>
f. Termination by us with cause	Franchise Agmt. Sections 15.1-15.3 Part-Time/Self-Service Location Franchise Addendum Sec. F Full Time Location Franchise Addendum Section G	We may terminate if you default on any of your obligations. A default of one agreement/addendum with us, will at our election also constitute a default of every other agreement/addendum between you and us (subject to state law).
g. “Cause” defined – defaults which can be cured	Franchise Agmt. Section 15.2	You have 15 days to cure any curable defaults except where law requires longer. If you fail to cure in 15 days, we may terminate your franchise. Curable defaults are defaults not listed below in box h (subject to state law).
h. “Cause” defined – defaults which cannot be cured:	Franchise Agmt. Section 15.1	Except as prevented by law, non-curable defaults include: bankruptcy or insolvency ¹ ; voluntary or involuntary dissolution; levy against your assets; abandonment; loss of location; any complaint or dissatisfaction by owner or store manager of facility where franchise is located or objection by the facility owner or store manager to the continued operation of the Food Service Counter; conviction of felony or criminal misconduct; threat to public health or safety and/or failure to cure health and safety violations within 24 hours of notice; unlawful act, harassment or discrimination; unapproved transfer/assignment; breach of confidentiality or transfer restriction provisions of the franchise agreement; false statements in franchise

Provision	Sections In Franchise Agreement	Summary
		application or conduct which reflects materially and unfavorably on the operation and reputation of the franchise or franchise system; maintaining false books or records; submitting a false report; failure to discharge employee for embezzlement; interference with our other contractual relations; repeated failure to comply with Franchise Agreement; failure to cure misuse of Marks within 48 hours of notice; failure to satisfactorily complete our initial training program or to pass any required criminal background check and/or drug, tuberculosis or other chemical and disease testing; acts of dishonesty and/or moral turpitude (subject to state law).
i. Your obligations on termination/non-renewal	Franchise Agmt. Section 15.6	Obligations include: pay all amounts due to us and third parties including any expenses incurred because of your default; de-identification, no use of Marks; assign location to us and vacate premises; cancel assumed names; return manuals, customer lists, items showing our Marks and any other property of ours; return all property of the facility owner; pay expenses we incur; assign phone numbers; revise all websites and social media pages under your control to remove references to the Food Service Counter(s) and our Marks and system; at our request, assign to us all domains and social media accounts owned by you relating to the Food Service Counter(s); cooperate with us; and sign all documents we request to terminate your franchise; not destroy, damage, hide or take any equipment or inventory from the Food Service Counter without our written consent.
j. Assignment of contract by AFC	Franchise Agmt. Section 14.1	There is no restriction on our right to assign.
k. "Transfer" by you – defined	Franchise Agmt. Sections 14.2, 14.5	Includes transfer or assignment of Agreement or assets or ownership change, but excluding transfer of ownership from you individually to your entity.
l. AFC's approval of your transfer	Franchise Agmt. Sections 14.2, 14.5 and 14.9	We have the right to approve all transfers but will not unreasonably withhold approval. We have the right to withhold consent and probably will withhold consent to any transfer proposed to be entered into within 2 years of the date of the addendum for the location proposed to be transferred. We can also withhold approval if you plan on selling some but not all of your locations, if such locations are operated under one franchise agreement.

Provision	Sections In Franchise Agreement	Summary
m. Conditions for AFC's approval of transfer	Franchise Agmt. Section 14.9	You offer us right of first refusal, pay all amounts owing to us and any of our affiliates, pay transfer fee, sign general release and not take any security interest in assets of the business; terms of sale are not unduly burdensome to the new franchisee; new franchisee qualifies and cooperates with us, undergoes training, and signs current franchise agreement; owner of location where Food Service Counter is located consents; transaction closes within 90 days of us not exercising right of first refusal.
n. AFC's right of first refusal to buy your business	Franchise Agmt. Sections 14.6-14.7	We can match any offer for your business or offer of any sale.
o. AFC's option to buy your business	Franchise Agmt. Sections 14.6-14.7, 15.7 Part-Time/Self-Service Location Franchise Addendums Sections F.3-F.6. Full Time Location Franchise Addendum Section G.3-G.6.	We have option to buy your business under our right of first refusal and on expiration or termination of your agreement or any addendum. We also have the option to purchase any non-expired approved perishable inventory at your Food Service Counter(s) at the time of expiration or termination of your agreement or any addendum.
p. Your death or disability	Franchise Agmt. Sections 14.10, 14.11 and 14.12	Surviving heirs may operate the business if they can qualify within 180 days, or they may assign to an approved buyer. If we operate the business, we get reimbursed for our expenses and we get a management fee of \$450 per day.
q. Non-competition covenants during term of franchise	Franchise Agmt. Section 6.4	You must deal exclusively with us. No involvement with competing business (subject to state law).
r. Non-competition covenants after franchise is terminated or expires	Franchise Agmt. Sections 6.4	No competing business for 2 years within 5 miles in a major city, 10 miles in a metropolitan area other than a major city, and 15 miles in a rural area, of any Food Service Counters associated with us. A "major city" means any of the top 25 cities in the U.S. measured by population; a "metropolitan city" means any city other than a major city where the population density is greater than 1,000 people per square mile; and a "rural area" means an area whose population density is 1,000 people per square miles or less. (subject to state law).
s. Modification of the agreement	Franchise Agmt. Section 16.4	No modification except in writing signed by you and us. Manuals may change, including Operating Manuals.
t. Integration/merger clause	Franchise Agmt. Section 16.3	Only the terms of the Franchise Agreement or other applicable agreement are binding (subject to state law). Other promises and representations are not enforceable. Nothing in the agreement is intended to disclaim our representations made in the franchise disclosure document.

Provision	Sections In Franchise Agreement	Summary
u. Dispute resolution by arbitration or mediation	Franchise Agmt. Section 16.8	Except for certain claims, all disputes must be arbitrated in Los Angeles, California, according to the rules of the American Arbitration Association (subject to state law). Failure to appear may cause a judgment of money to be awarded.
v. Choice of forum	Franchise Agmt. Sections 16.8	An action for a restraining order, injunctive or equitable relief described in box x below may be brought in any court. All other claims must be arbitrated in Los Angeles, California, subject to state law.
w. Choice of law	Franchise Agmt. Section 16.7	California law applies, except that if any provision of the Agreement would not be enforceable under California law, and if the Food Service Counter is located outside of California and such provision would be enforceable under the laws of the state in which the Food Service Counter is located, then such provision will be interpreted and construed under the laws of the state where the Food Service Counter(s) is/are located.

See also state specific addenda attached to this Disclosure Document as Exhibit O.

This table lists certain important provisions of the General Release. You should read these provisions in the agreement attached to this Disclosure Document.

Provision	Sections In General Release	Summary
a. Length of Franchise Term	Not Applicable	Not Applicable
b. Renewal or extension of the term	Not Applicable	Not Applicable
c. Requirements for you to renew or extend	Not Applicable	Not Applicable
d. Termination by you	Not Applicable	Not Applicable (subject to state law)
e. Termination by us without cause	Not Applicable	Not Applicable
f. Termination by us with cause	Not Applicable	Not Applicable (subject to state law)
g. "Cause" defined – defaults which can be cured	Not Applicable	Not Applicable (subject to state law)
h. "Cause" defined – defaults which cannot be cured:	Not Applicable	Not Applicable (subject to state law)
i. Your obligations on termination/non-renewal	Not Applicable	Not Applicable
j. Assignment of contract by AFC	Not Applicable	Not Applicable
k. "Transfer" by you – defined	Not Applicable	Not Applicable
l. AFC's approval of your transfer	Not Applicable	Not Applicable
m. Conditions for AFC's approval of transfer	Not Applicable	Not Applicable
n. AFC's right of first refusal to buy your business	Not Applicable	Not Applicable

Provision	Sections In General Release	Summary
o. AFC's option to buy your business	Not Applicable	Not Applicable
p. Your death or disability	General Release Section 8.4	The General Release is binding on and inures to the benefit of the parties and their respective heirs, successors and permitted assigns.
q. Non-competition covenants during term of franchise	Not Applicable	Not Applicable (subject to state law)
r. Non-competition covenants after franchise is terminated or expires	Not Applicable	Not Applicable (subject to state law)
s. Modification of the agreement	General Release Section 8.1	The General Release cannot be modified, altered or otherwise amended except by an agreement in writing.
t. Integration/merger clause	General Release Section 8.2	Only the terms of the Release Agreement is binding (subject to state law). Other promises and representations are not enforceable. Nothing in the agreement is intended to disclaim our representations made in the franchise disclosure document.
u. Dispute resolution by arbitration or mediation	General Release Sections 6 and 8.8	All disputes must be arbitrated in Los Angeles, California, according to the rules of the American Arbitration Association (subject to state law). Failure to appear may cause a judgment of money to be awarded.
v. Choice of forum	General Release Sections 8.7 and 8.8	All claims, except as precluded by applicable law, must be arbitrated in Los Angeles, California and are subject to state law.
w. Choice of law	General Release Section 8.7	California law applies, except that if any provision of the Agreement would not be enforceable under California law, and if the Food Service Counter is located outside of California and such provision would be enforceable under the laws of the state in which the Food Service Counter is located, then such provision will be interpreted and construed under the laws of the state where the Food Service Counter is located.

This table lists certain important provisions of the Asset Sale and Purchase Agreement. You should read these provisions in the agreement attached to this Disclosure Document.

Provision	Sections In Asset Sale and Purchase Agreement	Summary
a. Length of Franchise Term	Not Applicable	Not Applicable
b. Renewal or extension of the term	Not Applicable	Not Applicable
c. Requirements for you to renew or extend	Not Applicable	Not Applicable
d. Termination by you	Secs. 6 & 9.1	You can terminate the Asset Purchase Agreement if the parties do not comply with the Bulk Sales Laws and this requirement has not been waived by you (subject to state law).

Provision	Sections In Asset Sale and Purchase Agreement	Summary
e. Termination by us without cause	Sec. 2.1	If the parties are not able to close the sale by the agreed on date we can terminate the Agreement.
f. Termination by us with cause	Secs. 7 & 9.1	We can terminate the Asset Purchase Agreement if your representations and warranties in the Agreement are incorrect, if you have not complied with all requirements and conditions of the Agreement, if you fail to provide information we require prior to closing, or if there are any actions or proceedings pertaining to the transactions contemplated by the agreement, and not waived by us (subject to state law).
g. "Cause" defined – defaults which can be cured	Not Applicable	Not Applicable (subject to state law)
h. "Cause" defined – defaults which cannot be cured:	Not Applicable	Not Applicable (subject to state law)
i. Your obligations on termination/non-renewal	Not Applicable	Not Applicable
j. Assignment of contract by AFC	Not Applicable	Not Applicable
k. "Transfer" by you – defined	Not Applicable	Not Applicable
l. AFC's approval of your transfer	Not Applicable	Not Applicable
m. Conditions for AFC's approval of transfer	Not Applicable	Not Applicable
n. AFC's right of first refusal to buy your business	Not Applicable	Not Applicable
o. AFC's option to buy your business	Not Applicable	Not Applicable
p. Your death or disability	Not Applicable	Not Applicable
q. Non-competition covenants during term of franchise	Not Applicable	Not Applicable (subject to state law)
r. Non-competition covenants after franchise is terminated or expires	Not Applicable	Not Applicable (subject to state law)
s. Modification of the agreement	Sec. 10.9	No modification except in writing signed by you and us.
t. Integration/merger clause	Sec. 10.5	Only terms of the Agreement and Exhibits are binding, subject to state law. Other promises and representations are not enforceable. Nothing in the agreement is intended to disclaim our representations made in the franchise disclosure document.
u. Dispute resolution by arbitration or mediation	Sec. 10.3	All disputes must be arbitrated in Los Angeles, California, according to the rules of the American Arbitration Association (subject to state law).
v. Choice of forum	Sec. 10.3	Arbitration to be held in Los Angeles, California, subject to state law
w. Choice of law	Sec. 10.4	California law applies, subject to state law.

This table lists certain important provisions of the Food Service Counter Transfer Agreement. You should read these provisions in the agreement attached to this Disclosure Document.

Provision	Sections In Food Service Counter Transfer Agreement	Summary
a. Length of Franchise Term	Not Applicable	Not Applicable
b. Renewal or extension of the term	Not Applicable	Not Applicable
c. Requirements for you to renew or extend	Not Applicable	Not Applicable
d. Termination by you	Not Applicable	Not Applicable (subject to state law)
e. Termination by us without cause	Not Applicable	Not Applicable
f. Termination by us with cause	Not Applicable	Not Applicable (subject to state law)
g. "Cause" defined – defaults which can be cured	Not Applicable	Not Applicable (subject to state law)
h. "Cause" defined – defaults which cannot be cured:	Not Applicable	Not Applicable (subject to state law)
i. Your obligations on termination/non-renewal	Not Applicable	Not Applicable
j. Assignment of contract by AFC	Not Applicable	Not Applicable
k. "Transfer" by you – defined	Not Applicable	Not Applicable
l. AFC's approval of your transfer	Not Applicable	Not Applicable
m. Conditions for AFC's approval of transfer	Not Applicable	Not Applicable
n. AFC's right of first refusal to buy your business	Not Applicable	Not Applicable
o. AFC's option to buy your business	Not Applicable	Not Applicable
p. Your death or disability	Not Applicable	Not Applicable
q. Non-competition covenants during term of franchise	Not Applicable	Not Applicable (subject to state law)
r. Non-competition covenants after franchise is terminated or expires	Not Applicable	Not Applicable (subject to state law)
s. Modification of the agreement	Sec. 13	No modification except in writing signed by you and us.
t. Integration/merger clause	Sec. 13	Only terms of the Agreement are binding. Other promises and representations are not enforceable (subject to state law). Nothing in the agreement is intended to disclaim our representations made in the franchise disclosure document.
u. Dispute resolution by arbitration or mediation	Sec. 10	All disputes must be arbitrated in Los Angeles, California, according to the rules of the American Arbitration Association (subject to state law).
v. Choice of forum	Sec. 10	Arbitration to be held in Los Angeles, California (subject to state law).
w. Choice of law	Sec. 9	California law applies (subject to state law).

This table lists certain important provisions of the Promissory Note. You should read these provisions in the agreement attached to this Disclosure Document.

Provision	Sections In Promissory Note	Summary
a. Length of Note Term	Sec. 1	The repayment term varies. You may pay off the Note earlier than its term.
b. Renewal or extension of the term	Not Applicable	Not Applicable
c. Requirements for you to renew or extend	Not Applicable	Not Applicable
d. Termination by you	Sec. 2	The Note is pre-payable on 30 days' notice(subject to state law).
e. Termination by us without cause	Not Applicable	Not Applicable
f. Termination by us with cause	Not Applicable	Not Applicable (subject to state law)
g. "Cause" defined – defaults which can be cured	Sec. 4	Failure to make any payment within 10 days after due date (subject to state law).
h. "Cause" defined – defaults which cannot be cured:	Sec. 4	Non-curable defaults are listed in the Franchise Agreement and in the Franchise Agreement chart above (subject to state law).
i. Your obligations on termination/non-renewal	Sec. 4	You must immediately pay remaining balance.
j. Assignment of contract by AFC	Sec. 13	No restrictions on our right to assign.
k. "Transfer" by you – defined	Sec. 13	You may not transfer or assign your obligations under the Note.
l. AFC's approval of your transfer	Sec. 13	You may not transfer or assign your obligations under the Note.
m. Conditions for AFC's approval of transfer	Sec. 13	You may not transfer or assign your obligations under the Note.
n. AFC's right of first refusal to buy your business	Not Applicable	Not Applicable
o. AFC's option to buy your business	Not Applicable	Not Applicable
p. Your death or disability	Not Applicable	Not Applicable
q. Non-competition covenants during term of franchise	Not Applicable	Not Applicable (subject to state law)
r. Non-competition covenants after franchise is terminated or expires	Not Applicable	Not Applicable (subject to state law)
s. Modification of the Note	Sec. 14	The Note cannot be modified or amended unless both parties agree in writing.
t. Integration/merger clause	Sec. 15	Only the terms of the Note are binding (subject to state law). Other promises and representations are not enforceable. Nothing in the Note is intended to disclaim our representations made in the franchise disclosure document.
u. Dispute resolution by arbitration or mediation	Not Applicable	Not Applicable (subject to state law).
v. Choice of forum	Sec. 12	Litigation may be brought in Los Angeles, California (subject to state law). We are not precluded from bringing an action in another court.
w. Choice of law	Sec. 9	California law applies (subject to state law).

Provision	Sections In Promissory Note	Summary
x. Acceleration	Sec. 4	If you fail to pay any installment within 10 days after its due date, or if you are in default under any of your other agreements or addendums with us, we can accelerate the Note and require you to pay entire unpaid balance and interest.

ITEM 18 PUBLIC FIGURES

We do not use any public figure to promote the franchise.

ITEM 19 FINANCIAL PERFORMANCE REPRESENTATIONS

The FTC’s Franchise Rule permits a franchisor to provide information about the actual or potential financial performance of its franchised and/or franchisor-owned outlets, if there is a reasonable basis for the information, and if the information is included in the disclosure document. Financial performance information that differs from that included in Item 19 may be given only if: (1) a franchisor provides the actual records of an existing outlet you are considering buying; or (2) a franchisor supplements the information provided in this Item 19, for example, by providing information about possible performance at a particular location or under particular circumstances.

We do not make any representations about a franchisee’s future financial performance or the past financial performance of company-owned or franchised outlets. We also do not authorize our employees or representatives to make any such representations either orally or in writing. If you are purchasing an existing outlet, however, we may provide you with the actual records of that outlet. If you receive any other financial performance information or projections of your future income, you should report it to the franchisor’s management by contacting Vincenzo Calcagni, 19700 Mariner Avenue, Torrance, California 90503, Telephone: (310) 604-3200, the Federal Trade Commission, and the appropriate state regulatory agencies.

ITEM 20 OUTLETS AND FRANCHISEE INFORMATION

**Table No. 1
Systemwide Outlet Summary
Zenshi Counters
for the years ended March 31 2023, 2024, and 2025¹**

Outlet Type	Year	Outlets at the Start of the Year	Outlets and the End of the Year	Net Change
Franchised	2023	0	0	0
	2024	0	2,217	+2,217
	2025	2,217	3,572	+1,355
Company Owned	2023	0	0	0
	2024	0	57	+57
	2025	57	190	+133
Total Outlets	2023	0	0	0
	2024	0	2,274	+2,274
	2025	2,274	3,762	+1,488

1. We rebranded many of our AFC Counters to “Zenshi” in fiscal year ending March 31, 2024. As a result, the number of outlets listed as open as of March 31, 2024 was abnormally high.

Table No. 2
Transfers of Outlets from Franchisees to New Owners (other than the franchisor)
Zenshi Counters
For the years ended March 31 2023, 2024, and 2025

State	Year	Number of Transfers
Alaska	2023	0
	2024	0
	2025	3
Alabama	2023	0
	2024	1
	2025	3
California	2023	0
	2024	1
	2025	47
Colorado	2023	0
	2024	1
	2025	10
Connecticut	2023	0
	2024	0
	2025	3
Florida	2023	0
	2024	3
	2025	48
Georgia	2023	0
	2024	11
	2025	31
Hawaii	2023	0
	2024	0
	2025	2
Idaho	2023	0
	2024	0
	2025	3
Illinois	2023	0
	2024	0
	2025	9
Indiana	2023	0
	2024	1
	2025	10
Kansas	2023	0
	2024	2
	2025	5
Kentucky	2023	0
	2024	0
	2025	8
Louisiana	2023	0
	2024	0
	2025	3

State	Year	Number of Transfers
Massachusetts	2023	0
	2024	0
	2025	5
Michigan	2023	0
	2024	0
	2025	1
Minnesota	2023	0
	2024	0
	2025	4
Mississippi	2023	0
	2024	0
	2025	3
North Carolina	2023	0
	2024	0
	2025	17
Nebraska	2023	0
	2024	0
	2025	4
New Mexico	2023	0
	2024	0
	2025	3
New York	2023	0
	2024	0
	2025	2
Oregon	2023	0
	2024	0
	2025	7
South Carolina	2023	0
	2024	0
	2025	5
Tennessee	2023	0
	2024	0
	2025	13
Texas	2023	0
	2024	0
	2025	10
Utah	2023	0
	2024	0
	2025	1
Virginia	2023	0
	2024	0
	2025	1
Vermont	2023	0
	2024	0
	2025	1
Washington	2023	0
	2024	1
	2025	7

State	Year	Number of Transfers
Wisconsin	2023	0
	2024	0
	2025	1
TOTALS:	2023	0
	2024	21
	2025	274

Table No. 3
Status of Franchised Outlets
Zenshi Counters
For years ended March 31 2023, 2024, and 2025 ^{1,2}

State	Year	Outlets at Start of Year	Outlets Opened ³	Terminations ³	Non – Renewals ³	Reacquired by Franchisor	Ceased Operations / Other Reasons ³	Outlets at End of Year ³
Alabama	2023	0	0	0	0	0	0	0
	2024	0	90	0	0	0	0	90
	2025	90	17	4	2	1	0	100
Alaska	2023	0	0	0	0	0	0	0
	2024	0	18	1	0	0	0	17
	2025	17	9	1	2	1	0	22
Arizona	2023	0	0	0	0	0	0	0
	2024	0	12	0	0	0	0	12
	2025	12	72	6	4	5	0	69
Arkansas	2023	0	0	0	0	0	0	0
	2024	0	0	0	0	0	0	0
	2025	0	1	0	0	0	0	1
California	2023	0	0	0	0	0	0	0
	2024	0	255	0	0	0	0	255
	2025	255	280	35	4	23	4	469
Colorado	2023	0	0	0	0	0	0	0
	2024	0	33	0	0	0	0	33
	2025	33	52	9	0	9	0	67
Connecticut	2023	0	0	0	0	0	0	0
	2024	0	0	0	0	0	0	0
	2025	0	40	0	0	0	1	39
Delaware	2023	0	0	0	0	0	0	0
	2024	0	0	0	0	0	0	0
	2025	0	2	0	0	0	0	2
District Of Columbia Washington, D.C.	2023	0	0	0	0	0	0	0
	2024	0	0	0	0	0	0	0
	2025	0	1	0	0	0	0	1
Florida	2023	0	0	0	0	0	0	0
	2024	0	549	0	0	0	1	548
	2025	548	368	15	1	12	9	879
Georgia	2023	0	0	0	0	0	0	0
	2024	0	343	0	0	0	1	342
	2025	342	59	18	1	11	2	369

State	Year	Outlets at Start of Year	Outlets Opened ³	Terminations ³	Non – Renewals ³	Reacquired by Franchisor	Ceased Operations / Other Reasons ³	Outlets at End of Year ³
Hawaii	2023	0	0	0	0	0	0	0
	2024	0	24	0	0	0	0	24
	2025	24	4	0	0	0	1	27
Idaho	2023	0	0	0	0	0	0	0
	2024	0	25	0	0	0	0	25
	2025	25	8	2	0	2	2	27
Illinois	2023	0	0	0	0	0	0	0
	2024	0	142	3	1	0	0	138
	2025	138	67	19	2	15	2	167
Indiana	2023	0	0	0	0	0	0	0
	2024	0	78	0	0	0	0	78
	2025	78	52	4	0	2	1	123
Kansas	2023	0	0	0	0	0	0	0
	2024	0	8	0	0	0	0	8
	2025	8	36	0	0	0	0	44
Kentucky	2023	0	0	0	0	0	0	0
	2024	0	69	0	0	0	0	69
	2025	69	8	2	0	1	0	74
Louisiana	2023	0	0	0	0	0	0	0
	2024	0	0	0	0	0	0	0
	2025	0	38	0	1	0	26	11
Maine	2023	0	0	0	0	0	0	0
	2024	0	0	0	0	0	0	0
	2025	0	6	2	0	2	0	2
Maryland	2023	0	0	0	0	0	0	0
	2024	0	9	0	0	0	0	9
	2025	9	7	2	1	1	0	12
Massachusetts	2023	0	0	0	0	0	0	0
	2024	0	18	0	0	0	0	18
	2025	18	67	11	0	10	0	64
Michigan	2023	0	0	0	0	0	0	0
	2024	0	1	0	0	0	0	1
	2025	1	2	0	0	0	0	3
Minnesota	2023	0	0	0	0	0	0	0
	2024	0	0	0	0	0	0	0
	2025	0	13	0	1	0	0	12
Mississippi	2023	0	0	0	0	0	0	0
	2024	0	0	0	0	0	0	0
	2025	0	4	0	1	0	0	3
Missouri	2023	0	0	0	0	0	0	0
	2024	0	4	0	0	0	0	4
	2025	4	41	4	0	3	1	37
Montana	2023	0	0	0	0	0	0	0
	2024	0	20	0	0	0	0	20
	2025	20	5	3	0	3	0	19

State	Year	Outlets at Start of Year	Outlets Opened ³	Terminations ³	Non – Renewals ³	Reacquired by Franchisor	Ceased Operations / Other Reasons ³	Outlets at End of Year ³
Nebraska	2023	0	0	0	0	0	0	0
	2024	0	0	0	0	0	0	0
	2025	0	11	0	0	0	0	11
Nevada	2023	0	0	0	0	0	0	0
	2024	0	4	0	0	0	0	4
	2025	4	15	3	0	3	0	13
New Hampshire	2023	0	0	0	0	0	0	0
	2024	0	0	0	0	0	0	0
	2025	0	2	0	0	0	0	2
New Jersey	2023	0	0	0	0	0	0	0
	2024	0	0	0	0	0	0	0
	2025	0	2	0	0	0	0	2
New Mexico	2023	0	0	0	0	0	0	0
	2024	0	3	0	0	0	0	3
	2025	3	29	2	0	0	0	30
New York	2023	0	0	0	0	0	0	0
	2024	0	0	0	0	0	0	0
	2025	0	52	17	2	17	1	15
North Carolina	2023	0	0	0	0	0	0	0
	2024	0	126	0	0	0	0	126
	2025	126	71	10	0	7	0	180
North Dakota	2023	0	0	0	0	0	0	0
	2024	0	0	0	0	0	0	0
	2025	0	2	0	0	0	0	2
Ohio	2023	0	0	0	0	0	0	0
	2024	0	2	0	0	0	0	2
	2025	2	1	0	0	0	0	3
Oklahoma	2023	0	0	0	0	0	0	0
	2024	0	0	0	0	0	0	0
	2025	0	4	0	1	0	0	3
Oregon	2023	0	0	0	0	0	0	0
	2024	0	41	0	0	0	0	41
	2025	41	40	11	0	10	0	60
Puerto Rico	2023	0	0	0	0	0	0	0
	2024	0	0	0	0	0	0	0
	2025	0	1	0	0	0	0	1
Rhode Island	2023	0	0	0	0	0	0	0
	2024	0	0	0	0	0	0	0
	2025	0	3	0	0	0	0	3
South Carolina	2023	0	0	0	0	0	0	0
	2024	0	79	0	0	0	0	79
	2025	79	36	4	1	4	1	105
South Dakota	2023	0	0	0	0	0	0	0
	2024	0	3	0	0	0	0	3
	2025	3	0	0	0	0	0	3

State	Year	Outlets at Start of Year	Outlets Opened ³	Terminations ³	Non – Renewals ³	Reacquired by Franchisor	Ceased Operations / Other Reasons ³	Outlets at End of Year ³
Tennessee	2023	0	0	0	0	0	0	0
	2024	0	102	0	0	0	0	102
	2025	102	7	4	0	2	1	102
Texas	2023	0	0	0	0	0	0	0
	2024	0	39	0	0	0	0	39
	2025	39	104	5	2	5	0	131
Utah	2023	0	0	0	0	0	0	0
	2024	0	0	0	0	0	0	0
	2025	0	5	0	1	0	0	4
Vermont	2023	0	0	0	0	0	0	0
	2024	0	0	0	0	0	0	0
	2025	0	6	0	0	0	0	6
Virginia	2023	0	0	0	0	0	0	0
	2024	0	55	0	0	0	0	55
	2025	55	21	5	0	2	1	68
Washington	2023	0	0	0	0	0	0	0
	2024	0	52	2	0	0	0	50
	2025	50	120	10	3	8	1	148
West Virginia	2023	0	0	0	0	0	0	0
	2024	0	22	0	0	0	0	22
	2025	22	2	0	0	0	0	24
Wisconsin	2023	0	0	0	0	0	0	0
	2024	0	0	0	0	0	0	0
	2025	0	1	0	0	0	0	1
Wyoming	2023	0	0	0	0	0	0	0
	2024	0	0	0	0	0	0	0
	2025	0	12	0	0	0	0	12
TOTALS:	2023	0	0	0	0	0	0	0
	2024	0	2,226	6	1	0	2	2,217
	2025	2,217	1,806	208	30	159	54	3,572

1. Our fiscal year end is March 31.

2. For some entries in the above chart, after a franchisee stopped operating a location due to termination, nonrenewal or other reason, and without AFC taking over operation, another franchisee was granted a franchise for the location. The location may have operated continuously, without interruption, or only a brief closure. In the table, these are counted as “Outlets Opened.” See Exhibit M for more detailed information on the number of new outlets (outlets not previously in existence) opened in our last fiscal year.

3. We rebranded many of our AFC Counters to “Zenshi” in fiscal year ending March 31, 2024. As a result, the number of outlets listed as open as of March 31, 2024 was abnormally high.

Table No. 4
Status of Company-Owned Outlets
Zenshi Counters
For the years ended March 31 2023, 2024, and 2025

State	Year	Outlets at Start of Year	Outlets Opened ¹	Outlets Reacquired From Franchisees	Outlets Closed ²	Outlets Sold To Franchisee	Outlets at End of the Year
Alabama	2023	0	0	0	0	0	0
	2024	0	1	3	0	0	4
	2025	4	1	1	0	2	4
Alaska	2023	0	0	0	0	0	0
	2024	0	0	1	0	0	1
	2025	1	0	1	0	1	1
Arizona	2023	0	0	0	0	0	0
	2024	0	0	0	0	0	0
	2025	0	1	5	0	0	6
California	2023	0	0	0	0	0	0
	2024	0	0	1	0	0	1
	2025	1	0	23	10	0	14
Colorado	2023	0	0	0	0	0	0
	2024	0	0	2	0	0	2
	2025	2	0	9	3	2	6
Delaware	2023	0	0	0	0	0	0
	2024	0	0	2	0	0	2
	2025	2	0	0	0	1	1
Florida	2023	0	0	0	0	0	0
	2024	0	0	0	0	0	0
	2025	0	0	12	8	0	4
Georgia	2023	0	0	0	0	0	0
	2024	0	1	0	0	0	1
	2025	1	0	11	9	1	2
Idaho	2023	0	0	0	0	0	0
	2024	0	1	1	0	0	2
	2025	2	0	2	0	1	3
Illinois	2023	0	0	0	0	0	0
	2024	0	1	11	0	0	12
	2025	12	3	15	0	1	29
Indiana	2023	0	0	0	0	0	0
	2024	0	1	0	0	0	1
	2025	1	0	2	1	1	1
Kentucky	2023	0	0	0	0	0	0
	2024	0	0	0	0	0	0
	2025	0	1	1	0	0	2
Louisiana	2023	0	0	0	0	0	0
	2024	0	0	0	0	0	0
	2025	0	4	0	4	0	0

State	Year	Outlets at Start of Year	Outlets Opened ¹	Outlets Reacquired From Franchisees	Outlets Closed ²	Outlets Sold To Franchisee	Outlets at End of the Year
Maine	2023	0	0	0	0	0	0
	2024	0	0	0	0	0	0
	2025	0	3	2	0	0	5
Maryland	2023	0	0	0	0	0	0
	2024	0	0	2	0	0	2
	2025	2	2	1	0	1	4
Massachusetts	2023	0	0	0	0	0	0
	2024	0	2	3	0	0	5
	2025	5	0	10	6	0	9
Missouri	2023	0	0	0	0	0	0
	2024	0	0	0	0	0	0
	2025	0	2	3	0	0	5
Montana	2023	0	0	0	0	0	0
	2024	0	1	0	0	0	1
	2025	1	0	3	0	1	3
Nevada	2023	0	0	0	0	0	0
	2024	0	0	0	0	0	0
	2025	0	0	3	3	0	0
New Hampshire	2023	0	0	0	0	0	0
	2024	0	0	0	0	0	0
	2025	0	4	0	1	0	3
New York	2023	0	0	0	0	0	0
	2024	0	0	0	0	0	0
	2025	0	1	17	0	0	18
North Carolina	2023	0	0	0	0	0	0
	2024	0	0	0	0	0	0
	2025	0	0	7	3	0	4
Oregon	2023	0	0	0	0	0	0
	2024	0	3	2	0	0	5
	2025	5	4	10	0	3	16
Pennsylvania	2023	0	0	0	0	0	0
	2024	0	0	0	0	0	0
	2025	0	3	0	0	0	3
Rhode Island	2023	0	0	0	0	0	0
	2024	0	0	0	0	0	0
	2025	0	1	0	0	0	1
South Carolina	2023	0	0	0	0	0	0
	2024	0	1	0	0	0	1
	2025	1	0	4	2	0	3
South Dakota	2023	0	0	0	0	0	0
	2024	0	0	0	0	0	0
	2025	0	2	0	1	0	1
Tennessee	2023	0	0	0	0	0	0
	2024	0	0	0	0	0	0
	2025	0	0	2	0	0	2

State	Year	Outlets at Start of Year	Outlets Opened ¹	Outlets Reacquired From Franchisees	Outlets Closed ²	Outlets Sold To Franchisee	Outlets at End of the Year
Texas	2023	0	0	0	0	0	0
	2024	0	0	0	0	0	0
	2025	0	0	5	4	0	1
Virginia	2023	0	0	0	0	0	0
	2024	0	0	1	0	0	1
	2025	1	0	2	0	1	2
Washington	2023	0	0	0	0	0	0
	2024	0	8	8	0	0	16
	2025	16	16	8	0	4	36
Wisconsin	2023	0	0	0	0	0	0
	2024	0	0	0	0	0	0
	2025	0	1	0	0	0	1
TOTALS:	2023	0	0	0	0	0	0
	2024	0	20	37*	0	0	57
	2025	57	49	159	55	20	190

* In fiscal year ending March 31, 2024, all 37 “Zenshi” outlets listed as required from franchisees are former AFC Food Service Counters we required from franchisees and rebranded as company-owned Zenshi Counters.

**Table No. 5
Zenshi Counters
Projected Openings as of March 31, 2025**

State	Franchise Agreements Signed But Outlet Not Opened	Projected New Franchised Outlet in the Next Fiscal Year	Projected New Company-Owned Outlets in the Next Fiscal Year
Alabama	0	2	0
Arizona	0	3	0
California	0	14	0
Florida	0	19	0
Georgia	0	10	0
Idaho	0	1	0
Illinois	0	2	0
Indiana	0	4	0
Kentucky	0	5	0
Massachusetts	0	2	0
New Mexico	0	1	0
New York	0	1	0
North Carolina	0	5	0
Oregon	0	1	0
South Carolina	0	5	0
Tennessee	0	3	0
Texas	0	1	0
Vermont	0	1	0
Virginia	0	1	0

State	Franchise Agreements Signed But Outlet Not Opened	Projected New Franchised Outlet in the Next Fiscal Year	Projected New Company-Owned Outlets in the Next Fiscal Year
Washington	0	5	0
West Virginia	0	1	0
TOTALS	0	87	0

Table No. 1
Systemwide Outlet Summary
AFC Food Service Counters
for the years ended March 31 2023, 2024, and 2025¹

Outlet Type	Year	Outlets at the Start of the Year	Outlets and the End of the Year	Net Change
Franchised	2023	4,019	4,069	+50
	2024	4,069	1,857	-2,212
	2025	1,857	434	-1,423
Company Owned	2023	151	205	+54
	2024	205	140	-65
	2025	140	52	-88
Total Outlets	2023	4,171	4,275	+104
	2024	4,275	1,997	-2,278
	2025	1,997	486	-1,511

1. We rebranded many of our AFC Counters to “Zenshi” in fiscal year ending March 31, 2024. As a result, the number of AFC outlets that ceased operations in the above table increased exponentially as of March 31, 2024. While many outlets ceased operating as AFC Counters, the majority are continuing to operate as Zenshi Counters.

Table No. 2
Transfers of Outlets from Franchisees to New Owners (other than the franchisor)
AFC Food Service Counters
For the years ended March 31 2023, 2024, and 2025

State	Year	Number of Transfers
Alabama	2023	3
	2024	7
	2025	0
Alaska	2023	1
	2024	2
	2025	1
Arizona	2023	5
	2024	8
	2025	0
California	2023	55
	2024	48
	2025	4

State	Year	Number of Transfers
Colorado	2023	9
	2024	14
	2025	1
Connecticut	2023	4
	2024	2
	2025	3
Florida	2023	74
	2024	52
	2025	0
Georgia	2023	32
	2024	38
	2025	0
Hawaii	2023	4
	2024	4
	2025	0
Idaho	2023	4
	2024	4
	2025	2
Iowa	2023	0
	2024	1
	2025	1
Illinois	2023	5
	2024	10
	2025	0
Indiana	2023	20
	2024	10
	2025	1
Iowa	2023	0
	2024	1
	2025	1
Kansas	2023	4
	2024	7
	2025	2
Kentucky	2023	2
	2024	9
	2025	1
Louisiana	2023	10
	2024	4
	2025	0
Maryland	2023	2
	2024	4
	2025	0
Massachusetts	2023	2
	2024	1
	2025	2
Michigan	2023	1
	2024	0
	2025	0

State	Year	Number of Transfers
Minnesota	2023	2
	2024	2
	2025	2
Missouri	2023	3
	2024	4
	2025	0
Montana	2023	3
	2024	1
	2025	0
Nebraska	2023	2
	2024	4
	2025	3
Nevada	2023	2
	2024	1
	2025	0
New Mexico	2023	6
	2024	3
	2025	3
New York	2023	6
	2024	5
	2025	0
North Carolina	2023	34
	2024	31
	2025	0
Ohio	2023	1
	2024	0
	2025	0
Oklahoma	2023	0
	2024	1
	2025	0
Oregon	2023	10
	2024	4
	2025	0
Rhode Island	2023	1
	2024	0
	2025	0
South Carolina	2023	6
	2024	7
	2025	0
Tennessee	2023	4
	2024	12
	2025	0
Texas	2023	17
	2024	10
	2025	1
Virginia	2023	8
	2024	7
	2025	0

State	Year	Number of Transfers
Washington	2023	11
	2024	14
	2025	1
West Virginia	2023	1
	2024	1
	2025	0
Wyoming	2023	0
	2024	1
	2025	0
TOTALS:	2023	354
	2024	333
	2025	28

Table No. 3
Status of Franchised Outlets
AFC Food Service Counters
For years ended March 31 2023, 2024, and 2025^{1,3}

State	Year	Outlets at Start of Year	Outlets Opened ²	Terminations ²	Non – Renewals ²	Reacquired by Franchisor	Ceased Operations / Other Reasons ²	Outlets at End of Year ²
Alaska	2023	30	3	1	0	0	10	22
	2024	22	3	2	0	0	17	6
	2025	6	0	0	1	0	4	1
Alabama	2023	104	23	11	2	3	2	109
	2024	109	14	5	2	3	90	23
	2025	23	0	3	0	3	9	8
Arkansas	2023	1	1	0	0	0	0	2
	2024	2	1	1	0	0	0	2
	2025	2	0	0	0	0	1	1
Arizona	2023	107	20	17	0	4	0	106
	2024	106	21	13	1	5	12	96
	2025	96	0	3	1	3	52	37
California	2023	587	80	47	3	5	18	594
	2024	594	26	16	3	5	275	321
	2025	321	0	4	3	2	217	95
Colorado	2023	72	3	2	0	0	0	73
	2024	73	11	6	4	2	33	39
	2025	39	0	0	0	0	37	2
Connecticut	2023	47	4	3	1	1	1	45
	2024	45	10	6	1	2	0	46
	2025	46	1	0	0	0	37	10
District Of Columbia (Wash, D.C.)	2023	9	1	1	0	2	0	7
	2024	7	1	0	0	0	0	8
	2025	8	1	0	0	0	3	6

State	Year	Outlets at Start of Year	Outlets Opened ²	Terminations ²	Non – Renewals ²	Reacquired by Franchisor	Ceased Operations / Other Reasons ²	Outlets at End of Year ²
Delaware	2023	3	0	0	0	0	0	3
	2024	3	0	0	2	0	0	1
	2025	1	0	0	0	0	1	0
Florida	2023	852	43	13	0	0	14	868
	2024	868	37	13	0	0	555	337
	2025	337	0	1	0	1	323	12
Georgia	2023	326	43	18	0	0	4	347
	2024	347	19	4	0	0	342	20
	2025	20	0	1	0	1	16	2
Hawaii	2023	36	2	0	0	0	0	38
	2024	38	3	0	0	0	24	17
	2025	17	0	0	0	0	6	11
Idaho	2023	28	2	2	0	5	0	23
	2024	23	9	3	0	1	25	3
	2025	3	0	0	0	0	2	1
Iowa	2023	1	0	0	0	0	0	1
	2024	1	0	0	0	0	0	1
	2025	1	0	0	0	0	0	1
Illinois	2023	192	19	15	0	6	5	185
	2024	185	10	7	3	2	139	44
	2025	44	0	0	2	0	35	7
Indiana	2023	117	4	2	0	0	2	117
	2024	117	13	9	0	0	80	41
	2025	41	0	0	0	0	40	1
Kansas	2023	44	2	2	0	2	0	42
	2024	42	1	0	0	0	8	35
	2025	35	0	0	0	0	35	0
Kentucky	2023	72	1	0	0	0	0	73
	2024	73	3	1	0	0	69	6
	2025	6	1	1	0	1	3	2
Louisiana	2023	73	6	6	0	4	1	68
	2024	68	8	4	0	4	22	46
	2025	46	0	1	0	0	44	1
Massachusetts	2023	81	12	7	1	0	1	84
	2024	84	12	11	0	0	19	66
	2025	66	0	0	0	0	49	17
Maryland	2023	27	2	0	0	0	2	27
	2024	27	5	5	0	2	9	16
	2025	16	0	0	1	0	4	11
Maine	2023	5	1	1	0	1	0	4
	2024	4	0	0	0	0	0	4
	2025	4	0	0	0	0	4	0
Michigan	2023	5	0	0	0	0	1	4
	2024	4	0	0	0	0	1	3
	2025	3	0	0	1	0	2	0

State	Year	Outlets at Start of Year	Outlets Opened ²	Terminations ²	Non – Renewals ²	Reacquired by Franchisor	Ceased Operations / Other Reasons ²	Outlets at End of Year ²
Minnesota	2023	19	1	1	0	3	0	16
	2024	16	3	1	0	1	1	16
	2025	16	0	2	0	0	9	5
Missouri	2023	38	7	1	0	0	0	44
	2024	44	2	3	0	2	4	37
	2025	37	0	0	0	0	37	0
Mississippi	2023	7	1	0	1	0	0	7
	2024	7	1	0	0	0	1	7
	2025	7	0	1	0	1	4	1
Montana	2023	21	4	4	0	1	0	20
	2024	20	4	3	0	0	20	1
	2025	1	0	0	0	0	1	0
North Carolina	2023	212	8	4	1	3	2	210
	2024	210	2	3	0	1	126	82
	2025	82	2	0	2	0	53	29
North Dakota	2023	2	0	0	0	0	0	2
	2024	2	1	1	0	1	0	1
	2025	1	0	0	0	0	1	0
Nebraska	2023	11	1	1	0	0	0	11
	2024	11	1	1	0	0	0	11
	2025	11	0	0	0	0	11	0
New Hampshire	2023	5	5	1	4	1	1	3
	2024	3	1	0	0	0	0	4
	2025	4	0	0	0	0	0	4
New Jersey	2023	3	0	0	0	0	0	3
	2024	3	0	0	0	0	2	1
	2025	1	0	0	0	0	1	0
New Mexico	2023	29	1	1	0	0	0	29
	2024	29	3	2	0	0	3	27
	2025	27	0	0	0	0	27	0
Nevada	2023	18	3	0	0	0	10	11
	2024	11	0	0	0	0	4	7
	2025	7	0	0	0	0	5	2
New York	2023	62	18	4	0	0	5	71
	2024	71	22	9	2	2	4	76
	2025	76	3	1	1	0	23	54
Ohio	2023	17	2	2	0	3	1	13
	2024	13	0	1	0	0	7	5
	2025	5	0	0	0	0	1	4
Oklahoma	2023	7	0	0	0	0	0	7
	2024	7	1	0	0	0	2	6
	2025	6	1	1	1	0	2	3
Oregon	2023	79	7	5	0	0	13	68
	2024	68	15	9	1	3	41	29
	2025	29	0	0	1	0	25	3

State	Year	Outlets at Start of Year	Outlets Opened ²	Terminations ²	Non – Renewals ²	Reacquired by Franchisor	Ceased Operations / Other Reasons ²	Outlets at End of Year ²
Pennsylvania	2023	14	6	1	0	0	1	18
	2024	18	0	1	1	1	5	10
	2025	10	0	1	0	1	2	6
Puerto Rico	2023	1	0	0	0	0	0	1
	2024	1	0	0	0	0	0	1
	2025	1	0	0	0	0	1	0
Rhode Island	2023	14	0	0	0	2	0	12
	2024	12	1	0	0	0	0	13
	2025	13	0	0	0	0	3	10
South Carolina	2023	107	11	6	1	0	1	110
	2024	110	13	5	3	0	80	35
	2025	35	2	0	0	0	28	9
South Dakota	2023	6	0	0	0	0	0	6
	2024	6	2	2	0	0	3	3
	2025	3	0	0	0	0	1	2
Tennessee	2023	104	12	5	0	2	1	108
	2024	108	11	5	0	0	102	12
	2025	12	1	2	0	2	0	9
Texas	2023	154	11	6	0	0	2	157
	2024	157	9	4	0	3	40	119
	2025	119	2	0	0	0	101	20
Utah	2023	4	2	0	0	0	0	6
	2024	6	0	1	0	0	1	4
	2025	4	0	0	0	0	4	0
Virginia	2023	90	6	6	0	2	0	88
	2024	88	15	11	0	4	56	32
	2025	32	3	0	0	0	11	24
Vermont	2023	12	3	2	0	0	0	13
	2024	13	0	0	0	0	1	12
	2025	12	1	0	0	0	4	9
Washington	2023	129	42	11	1	0	0	159
	2024	159	27	11	4	9	51	111
	2025	111	0	0	0	0	97	14
Wisconsin	2023	3	0	0	0	0	0	3
	2024	3	0	0	0	0	2	1
	2025	1	0	0	0	0	1	0
West Virginia	2023	21	2	1	0	3	0	19
	2024	19	4	0	0	0	22	1
	2025	1	0	0	0	0	1	0
Wyoming	2023	11	2	1	0	0	0	12
	2024	12	5	0	0	0	5	12
	2025	12	0	0	0	0	12	0
TOTALS:	2023	4,019	427	211	15	53	98	4,069
	2024	4,069	350	179	27	53	2,303	1,857
	2025	1,857	18	22	14	15	1390	434

1. Our fiscal year end is March 31.

2. For some entries in the above chart, after a franchisee stopped operating a location due to termination, nonrenewal or other reason, and without AFC taking over operation, another franchisee was granted a franchise for the location. The location may have operated continuously, without interruption, or only a brief closure. In the table, these are counted as “Outlets Opened.” See Exhibit M for more detailed information on the number of new outlets (outlets not previously in existence) opened in our last fiscal year.

3. We rebranded many of our AFC Counters to “Zenshi” in fiscal year ending March 31, 2024. As a result, the number of AFC outlets that ceased operations in the above table increased exponentially as of March 31, 2024. While many outlets ceased operating as AFC Counters, the majority are continuing to operate as Zenshi Counters. As of March 31, 2025, (i) 56 of the 1,390 outlets operating as AFC Counters listed in the above table ceased operations; (ii) none of the 1,390 outlets operating as AFC Counters listed in the above table rebranded to Wild Blue Counters; and (iii) 1,334 of the 1,390 outlets operating as AFC Counters listed in the above table rebranded to Zenshi Counters. As of March 31, 2024, (i) 65 of the 2,303 outlets operating as AFC Counters listed in the above table ceased operations; (ii) 12 of the 2,303 outlets operating as AFC Counters listed in the above table rebranded to Wild Blue Counters; and (iii) 2,226 of the 2,303 outlets operating as AFC Counters listed in the above table rebranded to Zenshi Counters.

Table No. 4
Status of Company-Owned Outlets
AFC Food Service Counters
For the years ended March 31 2023, 2024, and 2025

State	Year	Outlets at Start of Year	Outlets Opened ¹	Outlets Reacquired From Franchisees	Outlets Closed ²	Outlets Sold To Franchisee	Outlets at End of the Year
Alabama	2023	2	1	3	0	0	6
	2024	6	1	3	0	8	2
	2025	2	1	3	1	1	4
Alaska	2023	2	1	0	0	2	1
	2024	1	0	0	0	1	0
	2025	0	1	0	0	0	1
Arizona	2023	6	2	4	0	0	12
	2024	12	1	5	0	5	13
	2025	13	0	3	5	1	10
Arkansas	2023	1	0	0	0	1	0
	2024	0	0	0	0	0	0
	2025	0	0	0	0	0	0
California	2023	24	13	5	6	0	36
	2024	36	8	5	9	22	18
	2025	18	1	2	9	4	8
Colorado	2023	3	1	0	0	2	2
	2024	2	1	2	0	3	2
	2025	2	0	0	2	0	0
Connecticut	2023	1	1	1	1	0	2
	2024	2	1	2	0	3	2
	2025	2	0	0	2	0	0

State	Year	Outlets at Start of Year	Outlets Opened ¹	Outlets Reacquired From Franchisees	Outlets Closed ²	Outlets Sold To Franchisee	Outlets at End of the Year
District Of Columbia (Wash, D.C.)	2023	0	2	2	0	0	4
	2024	4	0	0	1	2	1
	2025	1	1	0	0	0	2
Florida	2023	2	1	0	1	1	1
	2024	1	0	0	0	1	0
	2025	0	0	1	0	0	1
Georgia	2023	5	1	0	0	5	1
	2024	1	0	0	0	1	0
	2025	0	0	1	0	0	1
Idaho	2023	0	0	5	0	0	5
	2024	5	3	1	0	6	3
	2025	3	0	0	3	0	0
Illinois	2023	9	10	6	2	0	23
	2024	23	0	2	0	18	7
	2025	7	2	0	7	0	2
Indiana	2023	1	0	0	0	1	0
	2024	0	0	0	0	0	0
	2025	0	0	0	0	0	0
Kansas	2023	0	0	2	0	0	2
	2024	2	0	0	0	1	1
	2025	1	0	0	1	0	0
Kentucky	2023	1	0	0	0	1	0
	2024	0	0	0	0	0	0
	2025	0	1	1	1	0	1
Louisiana	2023	1	0	4	1	1	3
	2024	3	0	4	0	3	4
	2025	4	0	0	4	0	0
Maine	2023	1	0	1	0	0	2
	2024	2	0	0	0	0	2
	2025	2	0	0	2	0	0
Maryland	2023	1	0	0	1	0	0
	2024	0	1	2	0	2	1
	2025	1	0	0	0	1	0
Massachusetts	2023	15	2	0	0	2	15
	2024	15	0	0	1	10	4
	2025	4	0	0	4	0	0
Minnesota	2023	3	0	3	1	1	4
	2024	4	1	1	1	2	3
	2025	3	0	0	1	1	1
Missouri	2023	7	0	0	0	7	0
	2024	0	2	0	0	0	2
	2025	2	0	0	1	1	0
Mississippi	2023	0	2	0	0	0	2
	2024	2	0	0	0	1	1
	2025	1	0	1	1	1	0

State	Year	Outlets at Start of Year	Outlets Opened ¹	Outlets Reacquired From Franchisees	Outlets Closed ²	Outlets Sold To Franchisee	Outlets at End of the Year
Montana	2023	1	0	1	0	0	2
	2024	2	0	2	0	4	0
	2025	0	0	0	0	0	0
Nevada	2023	3	0	0	3	0	0
	2024	0	0	0	0	0	0
	2025	0	0	0	0	0	0
New Hampshire	2023	5	1	1	0	0	7
	2024	7	0	0	1	0	6
	2025	6	0	0	6	0	0
New Jersey	2023	0	0	0	0	0	0
	2024	0	0	0	0	0	0
	2025	0	0	0	0	0	0
New Mexico	2023	0	0	0	0	0	0
	2024	0	2	0	0	2	0
	2025	0	0	0	0	0	0
New York	2023	2	13	0	0	1	14
	2024	14	11	2	0	11	16
	2025	16	2	0	11	1	6
North Carolina	2023	1	0	3	0	2	2
	2024	2	0	1	0	2	1
	2025	1	0	0	1	0	0
North Dakota	2023	0	0	0	0	0	0
	2024	0	0	1	0	0	1
	2025	1	0	0	1	0	0
Ohio	2023	1	0	3	2	0	2
	2024	2	0	0	2	0	0
	2025	0	1	0	0	0	1
Oregon	2023	5	3	0	0	0	8
	2024	8	1	3	0	8	4
	2025	4	0	0	4	0	0
Pennsylvania	2023	3	2	0	0	3	2
	2024	2	1	1	0	0	4
	2025	4	0	1	0	0	5
Rhode Island	2023	0	0	2	0	0	2
	2024	2	0	0	0	1	1
	2025	1	0	0	1	0	0
South Carolina	2023	1	1	0	0	0	2
	2024	2	0	0	0	2	0
	2025	0	0	0	0	0	0
Tennessee	2023	1	1	2	0	0	4
	2024	4	1	0	0	3	2
	2025	2	0	2	1	0	3
Texas	2023	5	0	0	1	1	3
	2024	3	14	3	0	3	17
	2025	17	1	0	15	0	3

State	Year	Outlets at Start of Year	Outlets Opened ¹	Outlets Reacquired From Franchisees	Outlets Closed ²	Outlets Sold To Franchisee	Outlets at End of the Year
Utah	2023	3	0	0	0	2	1
	2024	1	0	0	1	0	0
	2025	0	0	0	0	0	0
Virginia	2023	1	0	2	0	1	2
	2024	2	3	4	0	9	0
	2025	0	0	0	0	0	0
Vermont	2023	1	0	0	0	0	1
	2024	1	1	0	0	0	2
	2025	2	1	0	0	2	1
Washington	2023	31	9	0	0	12	28
	2024	28	7	9	1	23	20
	2025	20	0	0	19	0	1
West Virginia	2023	1	0	3	0	0	4
	2024	4	0	0	0	4	0
	2025	0	0	0	0	0	0
Wyoming	2023	1	0	0	0	1	0
	2024	0	0	0	0	0	0
	2025	0	0	0	0	0	0
TOTALS	2023	151	67	53	19	47	205
	2024	205	60	53	17	161	140
	2025	140	13	15	103	13	52

Table No. 5
AFC Food Service Counters
Projected Openings as of March 31, 2025

State	Franchise Agreements Signed But Outlet Not Opened	Projected New Franchised Outlet in the Next Fiscal Year	Projected New Company-Owned Outlets in the Next Fiscal Year
All States	0	0	0
TOTALS	0	0	0

Table No. 1
Systemwide Outlet Summary
Wild Blue Counters
for the years ended March 31 2023, 2024, and 2025

Outlet Type	Year	Outlets at the Start of the Year	Outlets and the End of the Year	Net Change
Franchised	2023	38	66	+28
	2024	66	126	+60
	2025	126	122	-4

Outlet Type	Year	Outlets at the Start of the Year	Outlets and the End of the Year	Net Change
Company Owned	2023	26	9	-17
	2024	9	41	+32
	2025	41	57	16
Total Outlets	2023	64	75	+11
	2024	75	167	+92
	2025	167	179	12

Table No. 2
Transfers of Outlets from Franchisees to New Owners (other than the franchisor)
Wild Blue Counters
For the years ended March 31 2023, 2024 and 2025

State	Year	Number of Transfers
California	2023	0
	2024	3
	2025	2
Florida	2023	1
	2024	0
	2025	0
Georgia	2023	0
	2024	0
	2025	1
Iowa	2023	0
	2024	0
	2025	1
Massachusetts	2023	0
	2024	0
	2025	1
New York	2023	1
	2024	1
	2025	0
North Carolina	2023	1
	2024	1
	2025	3
Ohio	2023	0
	2024	0
	2025	1
Vermont	2023	0
	2024	0
	2025	1
Virginia	2023	1
	2024	0
	2025	0
Texas	2023	1
	2024	3
	2025	0

State	Year	Number of Transfers
Utah	2023	0
	2024	1
	2025	0
TOTALS:	2023	5
	2024	9
	2025	10

Table No. 3
Status of Franchised Outlets
Wild Blue Counters
For years ended March 31 2023, 2024 and 2025 ¹

State	Year	Outlets at Start of Year	Outlets Opened	Terminations	Non – Renewals	Reacquired by Franchisor	Ceased Operations / Other Reasons	Outlets at End of Year
Alabama	2023	1	0	0	0	0	0	1
	2024	1	0	0	0	0	0	1
	2025	1	0	0	0	0	0	1
Arizona	2023	3	0	0	0	0	0	3
	2024	3	2	0	0	0	0	5
	2025	5	0	0	0	0	0	5
California	2023	10	8	0	0	0	1	17
	2024	17	13	2	0	2	0	26
	2025	26	8	0	0	0	0	34
Colorado	2023	0	0	0	0	0	0	0
	2024	0	1	0	0	0	0	1
	2025	1	0	0	0	0	0	1
Connecticut	2023	0	0	0	0	0	0	0
	2024	0	1	0	0	0	0	1
	2025	1	1	0	0	0	1	1
District Of Columbia (Wash, D.C.)	2023	1	0	0	0	0	0	1
	2024	1	2	1	0	1	0	1
	2025	1	0	0	0	0	0	1
Florida	2023	2	0	0	0	0	0	2
	2024	2	3	0	0	0	0	5
	2025	5	0	0	0	0	2	3
Georgia	2023	1	0	0	0	0	1	0
	2024	0	1	0	0	0	0	1
	2025	1	0	0	0	0	0	1
Illinois	2023	2	3	1	0	0	0	4
	2024	4	4	1	0	1	0	6
	2025	6	2	1	0	1	0	6
Indiana	2023	0	2	1	0	0	0	1
	2024	1	1	0	0	0	1	1
	2025	1	0	0	0	0	0	1
Kentucky	2023	1	0	0	0	0	0	1
	2024	1	0	0	0	0	0	1
	2025	1	0	0	0	0	1	0

State	Year	Outlets at Start of Year	Outlets Opened	Terminations	Non – Renewals	Reacquired by Franchisor	Ceased Operations / Other Reasons	Outlets at End of Year
Louisiana	2023	0	0	0	0	0	0	0
	2024	0	3	0	0	0	0	3
	2025	3	0	0	0	0	0	3
Maryland	2023	1	4	2	0	0	0	3
	2024	3	2	2	0	1	1	1
	2025	1	1	1	0	1	0	0
Massachusetts	2023	0	3	0	0	0	0	3
	2024	3	7	0	0	0	0	10
	2025	10	1	0	0	0	4	7
Michigan	2023	1	0	0	0	0	0	1
	2024	1	1	0	0	0	0	2
	2025	2	2	0	1	0	1	2
Minnesota	2023	0	3	1	0	0	0	2
	2024	2	0	0	0	0	0	2
	2025	2	1	0	0	0	1	2
Missouri	2023	0	1	0	0	0	0	1
	2024	1	1	0	0	0	0	2
	2025	2	0	0	0	0	0	2
New Hampshire	2023	1	0	0	0	0	1	0
	2024	0	0	0	0	0	0	0
	2025	0	0	0	0	0	0	0
New Jersey	2023	0	1	0	0	0	0	1
	2024	1	2	0	0	0	0	3
	2025	3	0	0	0	1	1	1
New Mexico	2023	0	0	0	0	0	0	0
	2024	0	1	0	0	0	0	1
	2025	1	1	1	0	1	0	0
New York	2023	1	2	0	0	0	0	3
	2024	3	5	1	0	1	0	6
	2025	6	1	0	1	0	0	6
North Carolina	2023	1	3	0	0	0	0	3
	2024	3	5	0	0	0	1	7
	2025	7	0	0	0	0	0	7
Ohio	2023	0	0	0	0	0	0	0
	2024	0	4	0	0	0	0	4
	2025	4	0	0	0	0	0	4
Oklahoma	2023	0	0	0	0	0	0	0
	2024	0	1	0	0	0	0	1
	2025	1	0	0	0	0	0	1
Oregon	2023	1	1	0	0	0	0	2
	2024	2	0	0	0	0	1	1
	2025	1	1	1	0	1	0	0
Pennsylvania	2023	6	2	1	0	0	1	6
	2024	6	8	0	0	0	2	12
	2025	12	2	1	0	1	1	11

State	Year	Outlets at Start of Year	Outlets Opened	Terminations	Non – Renewals	Reacquired by Franchisor	Ceased Operations / Other Reasons	Outlets at End of Year
Rhode Island	2023	0	0	0	0	0	0	0
	2024	0	1	0	0	0	0	1
	2025	1	0	0	0	0	0	1
South Carolina	2023	1	0	0	0	0	1	0
	2024	0	0	0	0	0	0	0
	2025	0	0	0	0	0	0	0
Tennessee	2023	0	0	0	0	0	0	0
	2024	0	1	0	0	0	0	1
	2025	1	0	0	0	0	0	1
Texas	2023	3	1	0	0	0	0	4
	2024	4	5	0	0	0	0	9
	2025	9	1	0	0	0	1	9
Utah	2023	0	0	0	0	0	0	0
	2024	0	2	0	0	0	0	2
	2025	2	0	0	0	0	0	2
Vermont	2023	0	0	0	0	0	0	0
	2024	0	1	0	0	0	0	1
	2025	1	0	0	0	0	0	1
Virginia	2023	1	6	2	0	0	0	5
	2024	5	2	0	0	2	0	5
	2025	5	3	2	0	2	0	4
Washington	2023	0	2	0	0	0	0	2
	2024	2	2	0	1	1	0	2
	2025	2	0	0	0	0	0	2
Wisconsin	2023	0	0	0	0	0	0	0
	2024	0	1	0	0	0	0	1
	2025	1	1	0	0	0	0	2
TOTALS:	2023	38	41	8	0	0	5	66
	2024	66	83	7	1	9	6	126
	2025	126	26	7	2	8	13	122

1. Our fiscal year end is March 31.
2. For some entries in the above chart, after a franchisee stopped operating a location due to termination, nonrenewal or other reason, and without AFC taking over operation, another franchisee was granted a franchise for the location. The location may have operated continuously, without interruption, or only a brief closure. In the table, these are counted as “Outlets Opened.” See Exhibit M for more detailed information on the number of new outlets (outlets not previously in existence) opened in our last fiscal year.

Table No. 4
Status of Company-Owned Outlets
Wild Blue Counters
For the years ended March 31 2023, 2024 and 2025

State	Year	Outlets at Start of Year	Outlets Opened	Outlets Reacquired From Franchisees	Outlets Closed	Outlets Sold To Franchisee	Outlets at End of the Year
Alaska	2023	0	1	0	0	0	1
	2024	1	0	0	0	0	1
	2025	1	0	0	1	0	0
California	2023	4	0	0	0	3	1
	2024	1	5	2	0	0	8
	2025	8	2	0	0	1	9
Colorado	2023	0	0	0	0	0	0
	2024	0	0	0	0	0	0
	2025	0	1	0	0	0	1
District of Columbia (Wash, D.C.)	2023	0	0	0	0	0	0
	2024	0	0	1	0	0	1
	2025	1	0	0	1	0	0
Illinois	2023	5	0	0	0	4	1
	2024	1	7	1	0	0	9
	2025	9	2	1	1	0	11
Louisiana	2023	0	1	0	0	0	1
	2024	1	0	0	0	1	0
	2025	0	0	0	0	0	0
Massachusetts	2023	1	0	0	0	1	0
	2024	0	0	0	0	0	0
	2025	0	0	0	0	0	0
Maryland	2023	1	0	0	0	1	0
	2024	0	0	1	0	0	1
	2025	1	3	1	0	0	5
Michigan	2023	0	0	0	0	0	0
	2024	0	1	0	0	0	1
	2025	1	1	0	0	1	1
Missouri	2023	0	0	0	0	0	0
	2024	0	0	0	0	0	0
	2025	0	1	0	0	0	1
New Jersey	2023	1	0	0	0	0	1
	2024	1	0	0	0	0	1
	2025	1	3	1	0	0	5
New Mexico	2023	0	0	0	0	0	0
	2024	0	0	0	0	0	0
	2025	0	0	1	0	0	1
New York	2023	1	1	0	0	0	2
	2024	2	0	1	0	0	3
	2025	3	3	0	1	1	4

State	Year	Outlets at Start of Year	Outlets Opened	Outlets Reacquired From Franchisees	Outlets Closed	Outlets Sold To Franchisee	Outlets at End of the Year
Oregon	2023	1	0	0	0	1	0
	2024	0	0	0	0	0	0
	2025	0	0	1	1	0	0
Pennsylvania	2023	2	1	0	0	2	1
	2024	1	1	0	0	0	2
	2025	2	1	1	0	0	4
Virginia	2023	0	1	0	0	0	1
	2024	1	0	2	0	0	3
	2025	3	0	2	2	0	3
Washington	2023	10	0	0	0	10	0
	2024	0	10	1	0	0	11
	2025	11	2	0	1	0	12
Wisconsin	2023	0	0	0	0	0	0
	2024	0	0	0	0	0	0
	2025	0	0	0	0	0	0
TOTALS	2023	26	5	0	0	22	9
	2024	9	24	9	0	1	41
	2025	41	19	8	8	3	57

Table No. 5
Wild Blue Counters
Projected Openings as of March 31, 2025

State	Franchise Agreements Signed But Outlet Not Opened	Projected New Franchised Outlet in the Next Fiscal Year	Projected New Company-Owned Outlets in the Next Fiscal Year
California	0	6	0
Florida	0	1	0
Illinois	0	1	0
Massachusetts	0	3	0
Michigan	0	2	0
New Jersey	0	1	0
Pennsylvania	0	2	0
Virginia	0	1	0
TOTALS	0	17	0

Attached to this Disclosure Document as Exhibit M is a list of the names, addresses and phone numbers of all our existing U.S. franchisees as of March 31, 2025. Also enclosed as Exhibit M is a list of U.S. franchisees terminated, cancelled or not renewed or who otherwise voluntarily or involuntarily ceased to do business in the year ending March 31, 2025 or who have not communicated with us in the 10 weeks preceding the issuance date. If you buy this franchise, your contact information may be disclosed to other buyers when you leave the franchise system.

During the last three fiscal years, we have signed one confidentiality agreement with the estate of a former franchisee. In some instances, current, and former franchisees sign provisions restricting their ability to speak openly about their experience with us. You may wish to speak with current and former franchisees, but be aware that not all such franchisees will be able to communicate with you.

There are no trademark-specific franchisee organizations associated with the franchise system being offered which we have created, sponsored or endorsed. There are no independent franchisee organizations that have asked to be included in this disclosure document.

ITEM 21 FINANCIAL STATEMENTS

Attached to this Disclosure Document as Exhibit A are our audited financial statements for fiscal years ending March 31, 2025, March 31, 2024 and March 31, 2023. Our fiscal year end is March 31st.

ITEM 22 CONTRACTS

Attached as Exhibits B, C, D, E, F, G, H, I, J, K and P is our Franchise Application, Franchise Agreement, Full-Time Location Franchise Addendum, Part-Time Location Addendum, Self-Service Location Addendum, General Release, Assignment of Franchise Agreement and Franchisor Consent, Asset Sale and Purchase Agreement, Food Service Counter Transfer Agreement, Promissory Note and Confidentiality Agreement. Attached as Exhibit O are the State Specific Addenda which you may need to sign.

ITEM 23 RECEIPTS

The Receipts to this Disclosure Document are attached as the last pages under Exhibit R, as separate and detachable pages (one to be signed by you and returned to us and the other to be kept by you).

EXHIBIT A
FINANCIAL STATEMENTS

**AUDITED FINANCIAL STATEMENTS
FOR THE YEARS ENDED MARCH 31,
2025, MARCH 31, 2024, AND MARCH 31,
2023**

ADVANCED FRESH CONCEPTS FRANCHISE CORP.
FINANCIAL REPORT
MARCH 31, 2025

ADVANCED FRESH CONCEPTS FRANCHISE CORP.
CONTENTS

	Page
INDEPENDENT AUDITOR'S REPORT	1 – 2
FINANCIAL STATEMENTS	
Balance Sheets	3 – 4
Statements of Comprehensive Income	5
Statements of Changes in Stockholder's Equity	6
Statements of Cash Flows	7 – 8
Notes to Financial Statements	9 – 22

INDEPENDENT AUDITOR'S REPORT

Board of Directors
Advanced Fresh Concepts Franchise Corp.

Opinion

We have audited the financial statements of Advanced Fresh Concepts Franchise Corp. (the "Company"), which comprise the balance sheets as of March 31, 2025 and 2024, the related statements of comprehensive income, changes in stockholder's equity, and cash flows for each of the three years in the period ended March 31, 2025, and the related notes to the financial statements.

In our opinion, the accompanying financial statements present fairly, in all material respects, the financial position of the Company as of March 31, 2025 and 2024, and the results of its operations and its cash flows for each of the three years in the period ended March 31, 2025 in accordance with accounting principles generally accepted in the United States of America.

Basis for Opinion

We conducted our audits in accordance with auditing standards generally accepted in the United States of America (GAAS). Our responsibilities under those standards are further described in the Auditor's Responsibilities for the Audit of the Financial Statements section of our report. We are required to be independent of the Company and to meet our other ethical responsibilities, in accordance with the relevant ethical requirements relating to our audits. We believe that the audit evidence we have obtained is sufficient and appropriate to provide a basis for our audit opinion.

Emphasis of Matter

As disclosed in Notes 2, 5 and 8 to the financial statements, the Company and the results of its operations are dependent on transactions with the parent company and affiliates. Accordingly, the accompanying financial statements may not be indicative of the financial position or results of operations that would have occurred had the Company operated without such affiliation. Our opinion is not modified with respect to this matter.

Responsibilities of Management for the Financial Statements

Management is responsible for the preparation and fair presentation of the financial statements in accordance with accounting principles generally accepted in the United States of America, and for the design, implementation, and maintenance of internal control relevant to the preparation and fair presentation of financial statements that are free from material misstatement, whether due to fraud or error.

In preparing the financial statements, management is required to evaluate whether there are conditions or events, considered in the aggregate, that raise substantial doubt about the Company's ability to continue as a going concern within one year after the date that the financial statements are issued or available to be issued.

Auditor's Responsibilities for the Audit of the Financial Statements

Our objectives are to obtain reasonable assurance about whether the financial statements as a whole are free from material misstatement, whether due to fraud or error, and to issue an auditor's report that includes our opinion. Reasonable assurance is a high level of assurance but is not absolute assurance and therefore is not a guarantee that an audit conducted in accordance with GAAS will always detect a material misstatement when it exists. The risk of not detecting a material misstatement resulting from fraud is higher than for one resulting from error, as fraud may involve collusion, forgery, intentional omissions, misrepresentations, or the override of internal control. Misstatements are considered material if there is a substantial likelihood that, individually or in the aggregate, they would influence the judgment made by a reasonable user based on the financial statements.

In performing an audit in accordance with GAAS, we:

- Exercise professional judgment and maintain professional skepticism throughout the audit.
- Identify and assess the risks of material misstatement of the financial statements, whether due to fraud or error, and design and perform audit procedures responsive to those risks. Such procedures include examining, on a test basis, evidence regarding the amounts and disclosures in the financial statements.
- Obtain an understanding of internal control relevant to the audit in order to design audit procedures that are appropriate in the circumstances, but not for the purpose of expressing an opinion on the effectiveness of the Company's internal control. Accordingly, no such opinion is expressed.
- Evaluate the appropriateness of accounting policies used and the reasonableness of significant accounting estimates made by management, as well as evaluate the overall presentation of the financial statements.
- Conclude whether, in our judgment, there are conditions or events, considered in the aggregate, that raise substantial doubt about the Company's ability to continue as a going concern for a reasonable period of time.

We are required to communicate with those charged with governance regarding, among other matters, the planned scope and timing of the audit, significant audit findings, and certain internal control-related matters that we identified during the audit.

Singer Lewak LLP

July 10, 2025

ADVANCED FRESH CONCEPTS FRANCHISE CORP.

BALANCE SHEETS

March 31, 2025 and 2024

	ASSETS	
	2025	2024
Current assets		
Cash and cash equivalents	\$ 20,077,954	\$ 8,594,494
Accounts receivable, net of allowance for credit losses of \$437,870 and \$320,362, respectively	77,796,423	73,555,878
Due from related parties	9,161,337	38,867,212
Inventory	2,401,630	1,579,277
Prepaid expenses and other assets	1,362,314	1,570,012
Loans receivable – franchisees	481,923	424,984
Prepaid income taxes	1,588,626	1,502,136
Total current assets	112,870,207	126,093,993
Equipment, net	4,427,185	4,559,272
Operating lease right-of-use assets	92,813	150,631
Deposits and other asset	70,291	68,203
Deferred taxes	4,521,279	4,397,348
Total assets	\$ 121,981,775	\$ 135,269,447

(Continued)

See notes to financial statements.

ADVANCED FRESH CONCEPTS FRANCHISE CORP.

BALANCE SHEETS

March 31, 2025 and 2024

LIABILITIES AND STOCKHOLDER'S EQUITY

	2025	2024
Current liabilities		
Accounts payable	\$ 45,283,375	\$ 44,181,823
Due to related party	8,962,550	19,299,097
Accrued expenses and other liabilities	5,106,455	4,457,895
Income taxes payable	2,738,133	3,491,089
Operating lease liabilities, current portion	45,464	57,818
Current portion of deferred revenue	4,159,193	3,868,534
	<u>66,295,170</u>	<u>75,356,256</u>
Operating lease liabilities, noncurrent portion	47,349	92,813
Deferred revenue, net of current portion	8,679,118	8,530,460
	<u>75,021,637</u>	<u>83,979,529</u>
Stockholder's equity		
Common stock, no par value, authorized 100,000 shares, issued and outstanding 5,000 shares	500,000	500,000
Retained earnings	47,395,476	51,425,672
Accumulated other comprehensive loss	(935,338)	(635,754)
	<u>46,960,138</u>	<u>51,289,918</u>
Total liabilities and stockholder's equity	<u>\$ 121,981,775</u>	<u>\$ 135,269,447</u>

(Concluded)

See notes to financial statements.

ADVANCED FRESH CONCEPTS FRANCHISE CORP.

STATEMENTS OF COMPREHENSIVE INCOME Years Ended March 31, 2025, 2024 and 2023

	2025	2024	2023
Revenues			
Franchise revenue	\$ 408,637,052	\$ 410,865,584	\$ 405,225,599
Product revenue	250,728,389	240,193,646	219,136,610
Retail revenue	35,442,056	26,501,503	23,894,287
Total revenues	694,807,497	677,560,733	648,256,496
Costs and expenses			
Direct contract costs	266,105,960	250,609,777	228,685,015
Operating expenses	415,230,839	409,950,618	402,034,468
Total costs and expenses	681,336,799	660,560,395	630,719,483
Income from operations	13,470,698	17,000,338	17,537,013
Financial income (expense)			
Interest income	1,141,054	1,249,392	1,736,974
Interest expense	-	(3,561)	(596)
Net financial income	1,141,054	1,245,831	1,736,378
Income before provision for income taxes	14,611,752	18,246,169	19,273,391
Provision for income taxes	3,641,948	4,550,885	4,410,321
Net income	10,969,804	13,695,284	14,863,070
Other comprehensive loss			
Foreign currency translation adjustment	(299,584)	(5,950)	(366,744)
Total comprehensive income	\$ 10,670,220	\$ 13,689,334	\$ 14,496,326

See notes to financial statements.

ADVANCED FRESH CONCEPTS FRANCHISE CORP.
STATEMENTS OF CHANGES IN STOCKHOLDER'S EQUITY
Years Ended March 31, 2025, 2024 and 2023

	Common Stock		Retained Earnings	Accumulated Other Comprehensive Loss	Total
	Shares	Amount			
Balance at March 31, 2022	5,000	\$ 500,000	\$ 37,867,318	\$ (263,060)	\$ 38,104,258
Net income	-	-	14,863,070	-	14,863,070
Other comprehensive loss	-	-	-	(366,744)	(366,744)
Dividend paid	-	-	(10,000,000)	-	(10,000,000)
Balance at March 31, 2023	5,000	500,000	42,730,388	(629,804)	42,600,584
Net income	-	-	13,695,284	-	13,695,284
Other comprehensive loss	-	-	-	(5,950)	(5,950)
Dividend paid	-	-	(5,000,000)	-	(5,000,000)
Balance at March 31, 2024	5,000	500,000	51,425,672	(635,754)	51,289,918
Net income	-	-	10,969,804	-	10,969,804
Other comprehensive loss	-	-	-	(299,584)	(299,584)
Dividend paid	-	-	(15,000,000)	-	(15,000,000)
Balance at March 31, 2025	5,000	\$ 500,000	\$ 47,395,476	\$ (935,338)	\$ 46,960,138

See notes to financial statements.

ADVANCED FRESH CONCEPTS FRANCHISE CORP.

STATEMENTS OF CASH FLOWS

Years Ended March 31, 2025, 2024 and 2023

	2025	2024	2023
Cash flows from operating activities			
Net income	\$ 10,969,804	\$ 13,695,284	\$ 14,863,070
Adjustments to reconcile net income to net cash from operating activities:			
Deferred taxes	(12,668)	(451,070)	(447,775)
Depreciation expense	935,405	830,411	633,067
Bad debt expense	610,422	437,481	233,100
Noncash lease expense	57,818	56,723	50,189
Gain on disposition of equipment	(112,718)	(169,932)	(61,632)
Changes in operating assets and liabilities:			
Accounts receivable	(4,945,860)	(11,813,102)	(1,958,997)
Due from related parties	29,742,761	309,943	4,511,313
Inventory	(823,476)	(32,206)	(360,722)
Prepaid expenses and other assets	149,662	(108,835)	(129,245)
Prepaid income taxes	(88,564)	84,166	(212,681)
Deposits and other asset	(2,088)	(953)	(43,445)
Accounts payable	1,162,306	3,032,703	(6,998,380)
Due to related party	(10,334,374)	716,320	1,375,047
Accrued expenses and other liabilities	650,855	363,939	1,115,912
Income taxes payable	(752,956)	28,982	(108,801)
Operating lease liabilities	(57,818)	(56,723)	(50,189)
Deferred revenue	444,068	1,158,890	994,586
Net cash provided by operating activities	27,592,579	8,082,021	13,404,417
Cash flows from investing activities			
Purchases of equipment and for construction in progress	(895,856)	(2,462,809)	(1,748,785)
Proceeds from sales of equipment	202,187	182,355	175,883
Net cash used in investing activities	(693,669)	(2,280,454)	(1,572,902)
Cash flows from financing activities			
Principal payments on finance lease	-	(1,746)	(3,941)
Dividends paid	(15,000,000)	(5,000,000)	(10,000,000)
Net cash used in financing activities	(15,000,000)	(5,001,746)	(10,003,941)
Effect of exchange rate changes on cash and cash equivalents	(415,450)	(4,130)	(505,866)
Net increase in cash and cash equivalents	11,483,460	795,691	1,321,708
Cash and cash equivalents – beginning of year	8,594,494	7,798,803	6,477,095
Cash and cash equivalents – end of year	\$ 20,077,954	\$ 8,594,494	\$ 7,798,803

(Continued)

See notes to financial statements.

ADVANCED FRESH CONCEPTS FRANCHISE CORP.

STATEMENTS OF CASH FLOWS

Years Ended March 31, 2025, 2024 and 2023

	<u>2025</u>	<u>2024</u>	<u>2023</u>
Supplemental disclosure of cash flow information:			
Cash paid for interest	<u>\$ -</u>	<u>\$ 3,561</u>	<u>\$ 596</u>
Cash paid for income taxes	<u>\$ 4,938,168</u>	<u>\$ 5,270,688</u>	<u>\$ 5,244,059</u>

(Concluded)

See notes to financial statements.

ADVANCED FRESH CONCEPTS FRANCHISE CORP.

NOTES TO FINANCIAL STATEMENTS

NOTE 1 – ORGANIZATION AND SUMMARY OF SIGNIFICANT ACCOUNTING POLICIES

Organization

Advanced Fresh Concepts Franchise Corp. (the “Company”) was incorporated on April 30, 2002 in California. The Company is a wholly owned subsidiary of Advanced Fresh Concepts Corp. (the “Parent Company”). The principal business of the Company is to authorize and manage franchises for the operation of food service counters, primarily offering sushi, within supermarkets and other locations (collectively, the “facility owners”) pursuant to a certain system that was developed by the Parent Company. The food service counters began as outlets serving sushi and expanded into offering other Asian cuisine. While the Company primarily operates in the United States, beginning in September 2009, the Company initiated operations in Canada. In November 2018, the Parent Company was acquired by Zensho Holdings Co., Ltd. (“Zensho Holdings”) to become the ultimate parent of the Company. In April 2019, Zensho Holdings transferred its ownership in the Parent Company to Zensho USA Corporation, a wholly owned subsidiary of Zensho Holdings.

Basis of Accounting

The accompanying financial statements have been prepared in accordance with accounting principles generally accepted in the United States of America (U.S. GAAP).

Use of Estimates

The preparation of financial statements in conformity with U.S. GAAP requires management to make estimates and assumptions that affect the reported amounts of assets and liabilities and disclosure of contingent assets and liabilities at the date of the financial statements and the reported amounts of revenues and expenses during the reporting period. Actual results may differ from those estimates.

Cash and Cash Equivalents

Cash and cash equivalents include all cash balances and highly liquid investments with purchased maturities of three months or less.

Accounts Receivable

Accounts receivable represents the Company’s unconditional rights to considerations in exchange of goods and services transferred from franchise operations, sales of food and related products at the food service counter and product sales made to franchisees. Receivables are collectible from the facility owners and franchisees based on agreed payment terms. Amounts due from facility owners are dependent on the payment cycle which is generally on a weekly or monthly basis while payments on franchisee accounts are generally received on a monthly basis. Accounts receivable, net, opening balance at April 1, 2023 amounted to \$62,185,623.

The Company records accounts receivable at amortized cost less an allowance for credit losses. The Company measures its allowance for credit losses using an expected credit loss model utilizing a loss rate methodology which considers historical loss rates on its trade accounts receivable balances, adjusted for current economic and business conditions, and anticipated future economic events that may affect a customer’s ability to pay.

ADVANCED FRESH CONCEPTS FRANCHISE CORP.
NOTES TO FINANCIAL STATEMENTS

NOTE 1 – ORGANIZATION AND SUMMARY OF SIGNIFICANT ACCOUNTING POLICIES (Continued)

Accounts Receivable (Continued)

Accounts receivable are written off when deemed uncollectible. Recoveries of accounts receivable previously written off are recorded when received.

Inventory

Inventory is stated at the lower of cost (first-in, first-out basis) or net realizable value.

Equipment

Equipment is stated at cost. Depreciation of equipment is calculated by using the straight-line method over the estimated useful lives of the respective assets, as follows:

Vehicles	5 to 6 years
Computer equipment	3 to 5 years
Furniture and fixtures	5 to 7 years

Impairment of Long-lived Assets

Impairment losses are recorded on long-lived assets when events or changes in circumstances indicate that the carrying amount of the asset may not be recoverable. When required, impairment losses on assets to be held and used are recognized based on the excess of each asset's carrying amount over the estimated fair value of the asset.

Revenue Recognition

Revenue is measured based on a transaction price specified in a contract with a customer. The transaction price is the amount of consideration to which the Company expects to be entitled in exchange for transferring products and services to the customer. The Company excludes sales, use, and similar taxes from the measurement of the transaction price. The Company does not have significant variable consideration in its contracts.

The Company recognizes revenue when it satisfies a performance obligation by transferring control over a product or service to a customer either at a point in time or over time. Total approximate revenue recognized over time and at a point in time was as follows for the years ended March 31, 2025, 2024 and 2023:

	<u>2025</u>	<u>2024</u>	<u>2023</u>
Revenue recognized at a point in time	\$ 689,037,687	\$ 672,532,519	\$ 643,583,805
Revenue recognized over time	<u>5,769,810</u>	<u>5,028,214</u>	<u>4,672,691</u>
Total	<u>\$ 694,807,497</u>	<u>\$ 677,560,733</u>	<u>\$ 648,256,496</u>

ADVANCED FRESH CONCEPTS FRANCHISE CORP.

NOTES TO FINANCIAL STATEMENTS

NOTE 1 – ORGANIZATION AND SUMMARY OF SIGNIFICANT ACCOUNTING POLICIES (Continued)

Revenue Recognition (Continued)

The following is a description of the principal activities from which the Company generates its revenue, and the nature and timing of satisfaction of each performance obligation.

Franchise Revenue

The Company enters into a franchise agreement with franchisees and assesses the contract term as the period in which the parties to the contract have presently enforceable rights and obligations. The contract term is in line with the stated term in the contract at all times.

The specified promises that are licensed to the franchisee are the franchise rights, which include use of the name, trademarks, and proprietary methods. The franchisee is granted the right to operate at the facility pursuant to the Company's license agreements with the facility owners.

The Company also provides certain pre-opening services to franchisees such as training and orientation, systems implementation, and the design of a quality control program. These services are highly interrelated and not considered distinct from the franchise right.

Upfront payments related to franchise fees and pre-opening services are initially recorded in deferred revenue and revenue is recognized over the contract term. The Company believes that the impact of the financing component on upfront payment related to initial franchise fee is not significant at the contract level.

Related to the grant of a franchise right, the Company receives a sales-based royalty which is determined by the gross sales from franchised stores, less any commissions attributable to the franchisees. Revenue from sales-based royalties is recognized as the related sales occur at the franchised stores.

Revenue from services related to the franchise operations after the contract commencement such as laboratory, inspection, and web/data services, is recognized when the service is performed based on a stand-alone selling price.

Product Revenue

The Company sells food and supplies to franchisees through the online purchase order system that dictates the price, quantity of goods, payment terms, delivery terms, and other terms and conditions of the transaction.

Product revenue is recognized when food and supplies are shipped (for shipments from a related party's warehouse) or when products are delivered (for shipments from a third-party vendor) which indicates the transfer of control from the Company to the franchisee.

As a practical expedient, shipping and handling costs associated with outbound freight after control over a product has transferred to a customer are accounted for as a fulfillment cost and are included under direct contract costs in the statement of comprehensive income.

ADVANCED FRESH CONCEPTS FRANCHISE CORP.
NOTES TO FINANCIAL STATEMENTS

NOTE 1 – ORGANIZATION AND SUMMARY OF SIGNIFICANT ACCOUNTING POLICIES (Continued)

Revenue Recognition (Continued)

Retail Revenue

The Company generates revenue from the sale of food and related products to end customers, at its company-managed stores.

Company-managed store revenue is recognized when the sale is consummated, and control is transferred at the food service counter.

Costs and Expenses

Direct costs of sales and servicing of contracts with customers are recorded as direct contract costs as they are incurred. Direct costs also include costs incurred for shipping and handling of food and related products to franchisees. Operating expenses such as selling, general and administrative costs are charged in the statement of comprehensive income when incurred.

Advertising Costs

Advertising costs included in operating expenses are expensed as incurred. Advertising expense amounted to \$4,746,188, \$3,736,836, and \$2,712,419 for the years ended March 31, 2025, 2024 and 2023, respectively.

Leases

The Company determines if an arrangement is or contains a lease at inception, which is the date on which the terms of the contract are agreed to, and the agreement creates enforceable rights and obligations. A contract is or contains a lease when (i) explicitly or implicitly identified assets have been deployed in the contract and (ii) the Company obtains substantially all of the economic benefits from the use of that underlying asset and directs how and for what purpose the asset is used during the term of the contract. The Company also considers whether its service arrangements include the right to control the use of an asset.

The Company recognizes leases on its balance sheet as a right-of-use asset representing the right to use an underlying asset and a lease liability representing the obligation to make lease payments over the lease term, measured on a discounted basis. Leases are classified as either finance leases or operating leases based on certain criteria. Classification of the lease affects the pattern of expense recognition in the statement of comprehensive income.

ADVANCED FRESH CONCEPTS FRANCHISE CORP.

NOTES TO FINANCIAL STATEMENTS

NOTE 1 – ORGANIZATION AND SUMMARY OF SIGNIFICANT ACCOUNTING POLICIES (Continued)

Leases (Continued)

The Company made an accounting policy election available under Topic 842 not to recognize right-of-use assets and lease liabilities for leases with a term of 12 months or less. For all other leases, right-of-use assets and lease liabilities are measured based on the present value of future lease payments over the lease term at the commencement date of the lease. The right-of-use assets also include any initial direct costs incurred and lease payments made at or before the commencement date and are reduced by any lease incentives. To determine the present value of lease payments, the Company made an accounting policy election available to non-public companies to utilize a risk-free borrowing rate, which is aligned with the lease term at the lease commencement date.

The Company has made an accounting policy election to account for lease and non-lease components in their contracts as a single lease component for all asset classes.

Income Taxes

The Company is treated as a C corporation for federal and state income tax purposes. Income taxes are provided for the tax effects of transactions reported in the financial statements and consist of taxes currently due plus deferred taxes which relate to the temporary differences between financial and tax reporting.

The deferred tax assets and liabilities represent the future tax return consequences of those differences, which will either be taxable or deductible when the assets and liabilities are recovered and settled, respectively. Management records a valuation allowance to reduce its deferred taxes to the amount it believes is more likely than not to be realized. The amount of the deferred tax assets considered realizable, however, could be reduced in the near term if estimates of future income are reduced.

The Company recognizes the effect of income tax positions only if those positions are more likely than not of being sustained. The Company classifies interest and penalties related to unrecognized tax benefits, if incurred, as a component of income tax expense. To date, there have been no unrecognized tax positions.

Foreign Currency Transactions/Translation

The functional currency for the Company's Canadian operations is the applicable local currency which is the Canadian dollar. The translation of the applicable foreign currency into U.S. dollars is performed for balance sheet accounts using the current exchange rate in effect at the balance sheet date and for revenue and expense accounts using a weighted-average exchange rate during the period. The gains or losses, net of applicable income taxes, resulting from such translation are included as a component of stockholder's equity and classified as other comprehensive income or loss. Gains and losses resulting from foreign currency transactions are recorded in the statement of comprehensive income.

ADVANCED FRESH CONCEPTS FRANCHISE CORP.
NOTES TO FINANCIAL STATEMENTS

NOTE 1 – ORGANIZATION AND SUMMARY OF SIGNIFICANT ACCOUNTING POLICIES (Continued)

Recently Adopted Accounting Pronouncements

In March 2023, the FASB issued ASU 2023-01, *Leases (Topic 842): Common-Control Arrangements*, related to the accounting for leases between entities under common control. This ASU provides a practical expedient for private companies to consider only the written terms and conditions of a common-control arrangement for determination of whether a lease exists and the subsequent accounting for the lease. In addition, the ASU amends the accounting for leasehold improvements in common-control arrangements by requiring a lessee in a common-control lease arrangement to amortize leasehold improvements that it owns over the improvements' useful life to the common control group, regardless of the lease term, if the lessee continues to control the use of the underlying asset through a lease. The amendments in this ASU are effective for fiscal years beginning after December 15, 2023, including interim periods within those fiscal years. The Company adopted ASU 2023-01 on April 1, 2024. The adoption of this standard did not have a significant impact on the Company's financial statements.

Recent Accounting Pronouncements

In December 2023, the FASB issued ASU No. 2023-09, *Income Taxes (Topic 740): Improvements to Income Tax Disclosures*, which requires that an entity, on an annual basis, discloses additional income tax information, primarily related to the rate reconciliation and income taxes paid. The amendment in the ASU is intended to enhance the transparency and decision usefulness of income tax disclosures. The provisions of this standard are effective for annual periods beginning after December 15, 2025. The Company is currently evaluating the impact of this new guidance on its financial statements.

ADVANCED FRESH CONCEPTS FRANCHISE CORP.
NOTES TO FINANCIAL STATEMENTS

NOTE 2 – RELATED PARTY TRANSACTIONS

In recognition of certain benefits and services the Parent Company has provided the Company, the Company paid the Parent Company amounts totaling \$14,611,753, \$18,246,168, and \$19,273,390 for the years ended March 31, 2025, 2024, and 2023, respectively. On July 1, 2024, the Company, declared dividends of \$3,000 per share of outstanding stock of 5,000 shares to the Parent Company; dividends paid amounted to \$15,000,000. On June 29, 2023, the Company, declared dividends of \$1,000 per share of outstanding common stock of 5,000 shares to the Parent Company; dividends paid amounted to \$5,000,000. On September 15, 2022, the Company declared dividends of \$2,000 per share of outstanding common stock of 5,000 shares to the Parent Company; dividends paid amounted to \$10,000,000.

On July 1, 2016, the Company entered into an “Agreement for Franchise Operations” with Advanced Fresh Concepts Pty Ltd (“AFCPL”), a wholly owned Australian subsidiary of the Parent Company. Pursuant to the agreement, the Company granted AFCPL certain rights and privileges related to the franchising of food service counter operations in Australia and New Zealand. In recognition of the rights and privileges conveyed and administrative expenses not directly reimbursed, the Company will receive an annual service fee from AFCPL as stipulated in the agreement. The initial term is for five years, absent notification by either party, will renew for an additional five-year period. Service fee income related to this agreement amounted to \$2,012,829, \$2,376,942, and \$2,887,446 for the years ended March 31, 2025, 2024, and 2023, respectively.

Effective July 1, 2016, the Company began purchasing substantially all of their products from AFC Distribution Corp., a wholly owned subsidiary of the Parent Company. Prior to this, the Company had purchased most of their products from the Parent Company.

ADVANCED FRESH CONCEPTS FRANCHISE CORP.
NOTES TO FINANCIAL STATEMENTS

NOTE 2 – RELATED PARTY TRANSACTIONS (Continued)

The following is a summary of significant transactions and balances with the Parent Company and affiliates as of and for the years ended March 31, 2025, 2024, and 2023:

	2025	2024	2023
Due from Parent Company (see Note 5)	\$ 7,148,508	\$ 36,490,270	\$ 36,289,288
Due from affiliates	2,012,829	2,376,942	2,887,446
Due to affiliate	8,962,550	19,299,097	18,582,630
Purchases	242,834,229	229,046,919	206,428,162
Service fee expense	14,611,753	18,246,168	19,273,390
Service fee/management fee income	2,012,829	2,376,942	2,887,446
Dividend	15,000,000	5,000,000	10,000,000

NOTE 3 – CONCENTRATION OF CREDIT RISK AND OTHER RISKS

Risks

The Company maintains its cash accounts in two banks located in California and two banks in Canada. Management believes that the Company is not exposed to any significant risk related to cash and cash equivalents because of the high quality of the financial institutions where cash and cash equivalents are deposited.

For the year ended March 31, 2025, sales processed by the top two supermarket chains represented approximately 44% of total facility owner gross sales; as of March 31, 2025, approximately 31% of the accounts receivable from facility owners are associated with two supermarket chains.

For the year ended March 31, 2024, sales processed by the top two supermarket chains represented approximately 43% of total facility owner gross sales; as of March 31, 2024, approximately 37% of the accounts receivable from facility owners are associated with three supermarket chains.

For the year ended March 31, 2023, sales processed by the top two supermarket chains represented approximately 42% of total facility owner gross sales; as of March 31, 2023, approximately 30% of the accounts receivable from facility owners are associated with these two supermarket chains.

ADVANCED FRESH CONCEPTS FRANCHISE CORP.
NOTES TO FINANCIAL STATEMENTS

NOTE 4 – EQUIPMENT

At March 31, 2025 and 2024, equipment is summarized by major classifications as follows:

	2025	2024
Vehicles	\$ 3,055,402	\$ 3,376,436
Computer equipment	1,773,660	1,662,574
Furniture and fixtures	628,485	797,339
	5,457,547	5,836,349
Accumulated depreciation	(2,620,379)	(2,564,023)
	2,837,168	3,272,326
Construction in progress	1,590,017	1,286,946
	\$ 4,427,185	\$ 4,559,272

NOTE 5 – INCOME TAXES

The Company is included in the consolidated income tax returns of the Parent Company as a member of an affiliate group for U.S. federal and certain state income taxes. For financial reporting purposes, the provision for income taxes is computed as if the Company were filing on a separate return basis. The Parent Company pays federal and certain state income taxes on behalf of the Company. Federal income tax payable is determined based on the consolidated taxable income and allocated based on the individual taxable income of the members of the group. State income tax payable is calculated based on standalone taxable income for each state that the Company files a separate income tax return and combined taxable income of the group for each state a consolidated income tax return is filed with the payable amount allocated according to the filing requirement of each member of the group.

Outstanding income tax balances related to the Company's share in income tax liability that have been offset against due from Parent Company as of March 31, 2025 and 2024 amounted to \$3,100,968 and \$3,287,547, respectively. The components of the provision for income taxes for the years ended March 31, 2025, 2024, and 2023 are as follows:

	2025	2024	2023
Current taxes:			
Federal	\$ 2,715,944	\$ 3,556,076	\$ 3,316,665
State	760,033	1,321,642	1,356,769
Foreign	178,639	124,237	184,662
	3,654,616	5,001,955	4,858,096
Deferred taxes:			
Federal	(125,465)	(253,801)	(267,895)
State	112,797	(197,269)	(179,880)
	(12,668)	(451,070)	(447,775)
	\$ 3,641,948	\$ 4,550,885	\$ 4,410,321

ADVANCED FRESH CONCEPTS FRANCHISE CORP.
NOTES TO FINANCIAL STATEMENTS

NOTE 5 – INCOME TAXES (Continued)

The provisions for income taxes for the years ended March 31, 2025, 2024, and 2023 are different from the amounts computed by applying the statutory U.S. federal income tax rate to net income before income taxes primarily due to state/foreign income taxes, foreign-derived intangible income deduction, foreign tax credits and certain non-deductible items.

The components of the Company's deferred tax assets and liabilities at March 31, 2025 and 2024 are stated below:

	2025	2024
Deferred tax assets:		
Accrued vacation	\$ 277,000	\$ 264,000
Accrued bonus	218,000	297,000
Allowance for doubtful accounts	126,000	95,000
State taxes	-	36,348
Deferred revenue	3,684,000	3,669,000
Lease liabilities	27,000	45,000
Foreign tax credits	240,000	188,000
Translation adjustments	368,000	258,000
Total deferred tax assets	4,940,000	4,852,348
Deferred tax liabilities:		
Right-of-use assets	(27,000)	(45,000)
Research and development	(41,000)	(24,000)
State taxes	(36,721)	-
Equipment basis	(314,000)	(386,000)
Total deferred tax liabilities	(418,721)	(455,000)
Net deferred tax assets	\$ 4,521,279	\$ 4,397,348

As of March 31, 2025, the Company had foreign tax credit carryforwards for U.S. federal tax purposes of \$240,000 which expire in tax years 2033 to 2034.

The Company believes that its deferred tax assets are more likely than not to be realizable based on estimates of future taxable income.

NOTE 6 – FACILITY LICENSING CHARGES

The Company enters into license agreements with facility owners which allow the Company or franchisees to operate food service counters as separate departments within supermarkets and other venues. As provided in the license agreements, the facility owners are entitled to receive consideration equivalent to a certain percentage of gross sales collected at franchised stores and company-managed stores. Facility licensing charges constitute a cost of the Company in granting the franchise rights to franchisees and the cost of selling food and related products at the company-managed stores.

ADVANCED FRESH CONCEPTS FRANCHISE CORP.
NOTES TO FINANCIAL STATEMENTS

NOTE 6 – FACILITY LICENSING CHARGES (Continued)

Total gross sales at franchised stores and company-managed stores collected by facility owners amounted to \$1,196,589,998, \$1,207,837,708, and \$1,213,324,433 for the years ended March 31, 2025, 2024, and 2023, respectively.

The facility licensing charges presented under operating expenses in the statement of comprehensive income amounted to \$314,732,074, \$318,498,056, and \$320,391,751 for the years ended March 31, 2025, 2024, and 2023, respectively.

NOTE 7 – FRANCHISE OPERATIONS

The Company executes franchise agreements that set the terms of its arrangement with each franchisee for five years. If fully compliant with all requirements, a franchisee may generally renew their agreement upon the expiration of the agreement, which is usually for another period of five years.

Franchise revenue for the years ended March 31, 2025, 2024 and 2023 is as follows:

	2025	2024	2023
Sales-based royalty	\$ 398,436,714	\$ 400,795,516	\$ 396,642,891
Franchise fees	5,939,521	5,351,042	4,863,067
Others	4,260,817	4,719,026	3,719,641
	\$ 408,637,052	\$ 410,865,584	\$ 405,225,599

Others consist of mainly training fee and additional services that are being provided to franchisees.

As of March 31, 2025, the number of franchisees in the United States and Canada amounted to approximately 3,146 and 60, respectively. The number of franchisee-operated locations in the United States and Canada approximated 4,128 and 64, respectively.

As of March 31, 2024, the number of franchisees in the United States and Canada amounted to approximately 3,206 and 70, respectively. The number of franchisee-operated locations in the United States and Canada approximated 4,200 and 81, respectively.

In certain instances, the Company may temporarily operate a food service counter until a franchisee is found. The number of company-managed locations as of March 31, 2025 and 2024, is approximately 302 (United States – 299; Canada – 3) and 241 (United States – 238; Canada – 3), respectively.

ADVANCED FRESH CONCEPTS FRANCHISE CORP.
NOTES TO FINANCIAL STATEMENTS

NOTE 7 – FRANCHISE OPERATIONS (Continued)

As provided in the franchise agreement, franchisees are entitled to receive commissions based on a certain percentage of gross sales from franchised stores as agreed by the Company and the franchisee. These franchisee commissions amounted to \$762,711,228, \$780,540,690, and \$792,787,254 for the years ended March 31, 2025, 2024, and 2023, respectively. Amounts owed by the franchisees for food purchases, related products, and other charges are deducted from their commission.

NOTE 8 – 401(K) SAVINGS PLAN

The Company belongs to the AFC 401(k) Retirement Plan (the “Plan”) in which eligible employees of the Company can participate. The Plan is currently sponsored by the Parent Company. Under the Plan, eligible participants can elect to defer up to 90% of their wages, subject to statutory limitations. The Plan allowed for a matching contribution equal to 50% (25% prior to July 1, 2022) of the first 6% contributed by the employees. Employees are eligible to participate if the employee has one year of service with 1,000 hours of service completed. The Company’s contributions totaled \$320,509, \$222,222, and \$172,656 for the years ended March 31, 2025, 2024, and 2023, respectively.

NOTE 9 – LEASES

The Company leases central kitchen space and copy machines under operating lease agreements that expire in August 2025 to February 2028. The central kitchen space leases include an option to extend the lease term. The Company considers such an extension option in determining the lease term, when it is reasonably certain to exercise the extension option. As of March 31, 2025, all central kitchen space leases are considered short-term leases.

The Company had a vehicle lease classified as a finance lease with an interest rate of 0.73% which expired in August 2023. At March 31, 2023, this finance lease was included in other assets and amounted to \$1,692.

Operating lease cost is recognized on a straight-line basis over the lease term. The components of lease expense are as follows for the years ended March 31, 2025, 2024 and 2023:

	2025	2024	2023
Operating lease cost	\$ 63,170	\$ 62,633	\$ 52,848
Variable lease cost	29,946	18,865	-
Finance lease cost – amortization of right of use assets	-	423	5,075
Finance lease cost – interest on lease liabilities	-	34	596
Short-term lease cost	333,810	368,964	205,146
	<u>\$ 426,926</u>	<u>\$ 450,919</u>	<u>\$ 263,665</u>

ADVANCED FRESH CONCEPTS FRANCHISE CORP.
NOTES TO FINANCIAL STATEMENTS

NOTE 9 – LEASES (Continued)

Supplemental cash flow information related to leases is as follows for the years ended March 31, 2025, 2024 and 2023:

	<u>2025</u>	<u>2024</u>	<u>2023</u>
Cash paid for amounts included in measurement of lease liabilities:			
Operating cash outflows – payments on operating leases	\$ 57,818	\$ 56,723	\$ 50,189
Operating cash outflows – payments on finance leases	-	34	596
Financing cash outflows – payments on finance leases	-	1,746	3,941
Right-of-use assets obtained in exchange for lease obligations:			
Operating lease	-	127,292	-

As of March 31, 2025, 2024 and 2023, the lease term and discount rate for leases are as follows:

	<u>2025</u>	<u>2024</u>	<u>2023</u>
Weighted-average remaining lease term:			
Operating lease	2.19 years	2.95 years	2.26 years
Finance lease	-	-	0.37 years
Weighted-average discount rate:			
Operating lease	4.15%	3.93%	2.52%
Finance lease	-	-	0.73%

Future undiscounted cash flows for each of the next five years and thereafter and a reconciliation to the operating lease liabilities recognized on the balance sheet are as follows as of March 31, 2025:

Years Ending	
<u>March 31,</u>	
2026	\$ 48,428
2027	34,764
2028	<u>14,174</u>
Total lease payments	97,366
Less imputed interest	<u>(4,553)</u>
Total present value of lease liabilities	<u>\$ 92,813</u>

ADVANCED FRESH CONCEPTS FRANCHISE CORP.
NOTES TO FINANCIAL STATEMENTS

NOTE 10 – CONTINGENCIES

The Company is exposed to various asserted and unasserted legal claims, actions and complaints in the ordinary course of business including disputes regarding franchise agreement provisions or terminations, unfair business practices, product quality and trademark infringement. It is the opinion of management that the resolution of such claims will not have a material adverse effect on the financial position or results of operations of the Company.

NOTE 11 – SUBSEQUENT EVENTS

The Company has evaluated subsequent events through July 10, 2025, the date on which the financial statements were available to be issued.

EXHIBIT B

FRANCHISE APPLICATION



Advanced Fresh Concepts Franchise Corp.

Fax: 310-604-6449 Franchise Application Form Attn: _____

AFCFC welcomes and considers applicants for franchises without regard to race, color, religion, ancestry, national origin, age, disability, medical condition, genetic information, marital status, sexual orientation or other protected characteristics. AFCFC is an Equal Opportunity Franchisor.

Application # _____ Date of Application: _____

Applicant Information

Name _____
(Print) Last First Middle Other name SSN or any other identifying number

Current Address _____

City State Zip Code

Physical U.S. Residence, if different from above _____

City State Zip Code

Home Phone () _____ Work Phone () _____

Mobile () _____ E Mail _____

Where did you hear about us? _____

Location

Potential Franchisee

Location Preference _____

Anywhere Location 1 Location 2 Location 3

Education			
	Print the name and city of each school	Graduated Yes or No	Degree Awarded
High School			
College			
Vocational			

Employment Record

Are you currently working as a sushi chef or helper at an AFC Food Service Counter? Yes No
 If yes, where and who is your employer? _____

Have you ever worked at an AFC Food Service Counter before? Yes No
 If yes, when and where? _____

Have you ever worked at any Sushi Bar before? Yes No
 If yes, when and where? _____

Have you ever worked at a food service establishment before? Yes No
 If yes, when and where? _____
 (Continued on other side)

Are you now employed? Yes No

Can we contact your **present** employers for references? Yes No _____
 (Sign Here)

If you checked no, please explain _____

Can we contact your **former** employer(s) for references? Yes No _____
 (Sign Here)

If you checked no, please explain _____

List present and all former Employers or Personal Business (use additional sheets if necessary)

Dates Employed	Employer Name, Address and Phone #		Position	Reason for leaving

Other Information

Have you ever been convicted of a criminal offense (felony or misdemeanor)? Yes No
 (Convictions for marijuana-related offenses that are more than two years old need not be listed.)

If yes, state nature of the crime(s), when and where convicted, and disposition of the case? _____

A conviction does not automatically disqualify you from consideration for an AFC franchise.

Are you legally eligible to work in the United States? Yes No

Proof of Eligibility documentation must be provided before signing a franchise agreement as required by law.

Are you at least 18 years of age? Yes No

Are you now or have you been subject to any judgments, liens or garnishments within the last 5 years? Yes No

Real Estate Investments (list all real estate held)

Description or street address of property _____

Date of purchase _____ Cost _____

Monthly/Mortgage Payment _____ Balance _____

Emergency Contact

	Name	Address & Phone Number	Relationship
I			
II			

Name of friends and relatives who are employed by or are franchisees for AFC or AFCFC.

	Name	Relationship	Address & Phone No.
I			
II			

Name of family or friends who are currently operating other Sushi or Food Service Businesses.

	Name	Relationship	Address & Phone numbers
I			
II			

Personal, and Professional References

	Name	Phone	Address
I			
II			

Please read carefully and sign:

By signing below, I certify, represent and warrant that:

- 1. The undersigned personally completed this application;
- 2. The information provided in this application and any accompanying resume or documentation, is all true and correct;
- 3. I understand that any omission or false or misleading information on this application or in any document produced by me in connection with this application may disqualify me from further consideration and may lead to immediate termination of my franchise when discovered later, regardless of the time elapsed before discovery;
- 4. I authorize the investigation of all information, references, work records, education and all other matters related to my suitability to be a franchise owner. I further authorize the references listed above to disclose to AFCFC any and all letters, reports, and other information related to my work records, without providing me prior notice of such disclosure. I hereby release AFCFC, my former employers, and all other persons, corporations, partnerships, and associations from any and all claims, demands and/or liabilities arising out of or in any way related to such investigation or disclosure. I authorize AFCFC to conduct a background check on me and have signed the Disclosure and Authorization for Business Relationship form.
- 5. No representative of AFCFC has any authority to enter into any agreement for any specified period of time, or to make any agreement contrary to the foregoing, unless it is in writing and signed by an authorized company representative. No representative of AFCFC is authorized to provide me information or make any representation to me about actual or potential sales, profits or earnings. However, we may provide actual sales information for a specific outlet being offered to you for sale.
- 6. The information contained in this application is not confidential. I authorize AFCFC to provide this Application or any of its contents to the owner or management of any location(s) where it is possible I may operate an AFC food service counter.
- 7. I understand this is an Application, not an agreement. There is no promise to consider this Application or to grant me a franchise.

Applicant's Signature _____ **Date** _____

For Office use only

Interviewer	Action Taken	Position/Dept.	Starting Date	Store
Location				

--	--	--	--	--

EXHIBIT C

FRANCHISE AGREEMENT

FRANCHISE AGREEMENT

This Franchise Agreement (this "Agreement") is made and entered into on _____, 20__ between Advanced Fresh Concepts Franchise Corp. a California corporation whose address is 19700 Mariner Avenue, Torrance, California 90503 ("Franchisor"), and _____ whose address is _____ ("Franchisee"), with reference to the following facts:

RECITALS

Franchisor is the owner of certain intellectual property comprised of trademarks, know-how, trade secrets and other intangible property and a licensee of other marks, all comprising a system (the "AFC System") for developing and operating food service counters in grocery stores, retail stores and other locations. Franchisee desires to be granted a franchise to establish and operate food service counter(s) using the AFC System. Franchisor is willing to grant a franchise to Franchisee on the terms in this Agreement. Accordingly, the parties now agree as follows:

AGREEMENT

1. Appointment.

Franchisor grants to Franchisee, and Franchisee accepts, the right to operate one or more Zenshi Counter(s), AFC Food Service Counter(s), or Wild Blue Counter(s) (the "Food Service Counter(s)") as indicated in and at the location(s) identified in the Franchise Addendum(s) attached to this Agreement (the "Franchise Addendum(s)") using the AFC System as it may be modified or further developed by Franchisor, all according to the terms in this Agreement. Franchisee acknowledges that the Franchise Addendum(s) may be comprised of one or more of the following: Full-Time Location Franchise Addendum, Part-Time Location Franchise Addendum and/or Self-Service Location Addendum. Franchisee shall use Franchisee's best efforts to develop and expand the market for the goods and services offered by the Food Service Counter(s) and shall cooperate with Franchisor in accomplishing the purposes of this Agreement.

2. Term.

The term of this Agreement shall be five years starting on the date stated in the introductory paragraph of this Agreement and ending on the fifth anniversary of that date, notwithstanding any start date stated in any Franchise Addendum between Franchisee and Franchisor. Regardless of the term, this Agreement shall terminate earlier on the date this Agreement is terminated as provided in Sections 15.1 through 15.5. Further, at any time during the five year term, Franchisee may apply to Franchisor in writing to terminate this Agreement early, with the termination to be effective on the 90th day following delivery of written notice, or such earlier time as the parties mutually agree in writing. Franchisor shall have 30 days to accept Franchisee's early termination request. Franchisor's failure to accept Franchisee's request within such 30 day period shall be deemed Franchisor's election to reject Franchisee's early termination request.

3. Location(s).

3.1. Initial Location(s). Franchisee shall operate the Food Service Counter(s) only at the location(s) identified in the Franchise Addendum(s).

3.2. Relocation. In the event of the loss of the right or consent to operate at any of Franchisee's location(s), or the location owner's or manager's objection to Franchisee, without fault of Franchisee,

Franchisor shall attempt to identify a new location for Franchisee, and shall consent to relocation of the affected Food Service Counter to an alternate location and site acceptable to Franchisor. Any such relocation shall be at Franchisee's sole expense. Franchisee acknowledges that relocation may not be possible before expiration of the term of this Agreement, or at all; that any new location may not be comparable to the old; and that relocation, if possible, could involve a substantial interruption in operating the Food Service Counter until a new location is identified and prepared. Franchisee releases Franchisor and its affiliates, and each of their respective officers, directors, agents and employees from any loss of right or consent to operate at the location, and further agrees not to hold Franchisor liable for any such event during the term of this Agreement or thereafter.

3.3. Acknowledgment. Franchisee acknowledges that the right to locate any Food Service Counter at a particular location, may be derived from an agreement between Franchisor (or an entity affiliated with Franchisor, such as Advanced Fresh Concepts Corp.) and the owner or lessee of the location where the Food Service Counter is located; that the agreement may be modified or terminable by the owner and/or manager of the location at any time and on short notice; and/or the owner or facility manager may object to Franchisee operating there; and that modification, termination or objection by the owner or facility manager may therefore result in the need for relocation and resulting disruption and interruption to Franchisee or adjustment to the franchise operations (such as if the facility owner requests that the operations be converted from a full time location to a self-service, or part time location, and vice versa). Franchisee also acknowledges that the owner or facility manager may require changes to the type of food products offered at the Food Service Counter and other changes. Franchisee acknowledges that the choice of location (identified in the Franchise Addendum(s)), types of food offered at the location, types of operations (full time, part time or self-service) and right to continue operating at the location is subject to the location owner's and/or manager's consent.

3.4. No Exclusivity. This Agreement does not include any territory or marketing exclusivity. Franchisor shall have the right to operate or grant franchises or licenses to others to operate food service counters under the marks "Zenshi," "AFC," "Wild Blue," or any other mark anywhere, regardless of how close they are to the Food Service Counter(s) that Franchisee operates; to sell products and other items to anyone and anywhere (even in the facilities where Franchisee operates), including, but not limited to pre-packaged products and central kitchen products identified by the Marks (as defined below) or other marks, whether or not such marks are authorized for use by Franchisee, as well as other products or services under the Marks and other trademarks and service marks. Furthermore, Franchisor shall have the right to use other channels of distribution, such as the Internet, telemarketing, catalog sales, other direct marketing sales and other means to advertise, sell and distribute products to anyone and anywhere; and other Zenshi/AFC/Wild Blue Food Service Counters (regardless of who owns or operates them) may advertise to and solicit prospective customers regardless of geographic location. Franchisor shall have no obligation to compensate Franchisee for any sales made through these methods or any other methods.

3.5. Restrictions on Distribution Methods. Franchisee shall only sell products to end customers who are physically present at Franchisee's Food Service Counter(s). Franchisee shall not engage in the resale of any product or supply at wholesale, retail or otherwise without Franchisor's express written consent. Franchisee shall not use any other channels of distribution such as the Internet, catalog sales, telemarketing or otherwise to conduct sales.

4. Trademarks.

4.1. Ownership. Franchisee acknowledges that Franchisee owns no right, title, interest or goodwill in the trademarks “Zenshi,” “Advanced Fresh,” the oval AFC logo, “Wild Blue,” “Hybrid Sushi,” “Southern Tsunami,” the Southern Tsunami logo, or any other marks or trade dress that Franchisor adopts and permits Franchisee to use from time to time (collectively, the “Marks”); that as between Franchisee and Franchisor all right, title and interest in and to the Marks shall be deemed to be owned by Franchisor; that all usage of the Marks and goodwill established by that use is exclusively for Franchisor’s benefit; and that this Agreement does not confer any goodwill or other interests in the Marks on Franchisee.

4.2. Use. Franchisee shall not use any Mark or portion of any Mark as part of the name of any business entity. Franchisee shall not use any Mark in selling any unauthorized product or service or in any manner not expressly authorized in writing by Franchisor. Franchisee shall not establish an email address or an Internet web site or the like using any domain name containing the words “Zenshi,” “Advanced Fresh,” “AFC,” “Wild Blue,” “Hybrid Sushi,” “Southern Tsunami,” or any variation without Franchisor’s prior written consent. Franchisee shall only use the Marks associated with the Food Service Counter concept Franchisee is permitted to operate. Franchisee shall give notices of trademark and service mark registration that Franchisor specifies and obtain fictitious or assumed name registrations as may be required by applicable law. Franchisee shall restrict use of the Marks as may be required by each owner of the facility where the Food Service Counter(s) is/are located.

4.3. Notice. Franchisee shall notify Franchisor immediately of any claim or demand arising from any attempt by any other person or entity to use the Marks or any similar marks or if Franchisee discovers anyone else is infringing the Marks. Franchisor shall have the sole right and obligation to decide what action, if any, to take with regard to any such matter and Franchisee shall cooperate with Franchisor and execute any and all documents and take all actions that Franchisor requests with regard to the matter.

4.4. Change. If it becomes advisable at any time, in Franchisor’s sole discretion, for Franchisor to modify or discontinue use of any Mark, and/or use one or more additional or substitute trade names, trademarks, service marks or other commercial symbols, Franchisee shall comply with Franchisor’s directions to do so at Franchisee’s cost and expense.

4.5. Inspection. To preserve the validity and integrity of the Marks and to assist Franchisor in steps seeking to assure that Franchisee operates according to this Agreement and uses the Marks properly in operating the Food Service Counter(s), Franchisor or its agents shall have the right to enter and inspect the Food Service Counter(s), and to interview customers, suppliers or others, at all reasonable times. Franchisee shall fully cooperate with Franchisor in any inspection or visit Franchisor conducts and shall provide Franchisor’s personnel full access to the Food Service Counter(s) for this purpose. Any obstruction, interference or prohibition by Franchisee of Franchisor’s right to inspect the Food Service Counter(s), including, without limitation, to investigate threats or dangers to public health and safety, shall constitute a material breach of this Agreement. If Franchisor, in its sole discretion, determines that a lab test is required to test the quality, safety and freshness of the foods sold at any Food Service Counter operated by Franchisee, Franchisor shall have the right to assess Franchisee a lab fee of up to \$500 for each sample tested.

4.6 Location Exceptions. Franchisee acknowledges that at certain locations, Franchisee may not be able to use the Marks due to agreements with the facility owner. Franchisee shall abide by such requirements.

5. Confidential Operations Manuals.

5.1. Loan of Operations Manuals. Franchisor shall loan to Franchisee during the term of this Agreement one copy of Franchisor's confidential Operations Manual, one copy of Franchisor's Standard Sanitation Operating Procedure and Methods Manual, Recipe Manual(s) applicable to the franchise and one Steam Table Operating Manual, if applicable to Franchisee's business (collectively the "Manuals") for each Food Service Counter operated by Franchisee, except, no Manuals shall be provided for a Self Service location. The Manuals shall contain mandatory and suggested specifications, standards, operating procedures and rules prescribed from time to time by Franchisor for Food Service Counters. Franchisor shall have the right to modify the Manuals from time to time. Franchisee shall comply with the Manuals, as modified by Franchisor. Franchisee shall pay Franchisor's then current manual lease fee for each Manual received from Franchisor. The manual lease fee paid by Franchisee shall be refunded to Franchisee when Franchisee returns the Manuals to Franchisor within 30 days of the termination or expiration of this Agreement or any applicable addendum. For purpose of clarification, there shall be no refund if Franchisee fails to return the Manual(s) or returns any manual more than 30 days after expiration or termination of this Agreement or any applicable addendum.

5.2. Ownership. The Manuals shall be at all times the sole property of Franchisor. Franchisee shall return the Manuals immediately on expiration or termination of this Agreement. Franchisee shall not make and shall not let Franchisee's personnel make any copy of all or part of the Manuals.

5.3. Confidentiality. Franchisee acknowledges that the Manuals contains confidential information and that its loss or disclosure would cause substantial damage to Franchisor. Franchisee shall protect the Manuals as a trade secret of Franchisor.

6. Confidential Information.

6.1. Secrets. Franchisee acknowledges that Franchisor's product recipes, methods of preparing the products, and operating procedures for a Food Service Counter are valuable and secret in the sense that they are not generally known to competitors of Franchisor. Other information that Franchisor designates as confidential shall be deemed confidential for this Agreement, except information that Franchisee proves he or it knew before disclosure from Franchisor; or lawfully entered the public domain, through publication by others.

6.2. Protection. Franchisee shall maintain the confidentiality of all trade secrets during and after the term of this Agreement. Franchisee shall not use this information in any other business or in any manner not specifically authorized or approved in writing by Franchisor. Franchisee shall reveal the trade secrets to employees only to the extent they need the information to perform their jobs. Franchisee shall use reasonable precautions to require employees to keep the information confidential; and shall take any additional steps to protect confidentiality that Franchisor requests from time to time.

6.3. Acknowledgments. Franchisee acknowledges that (a) the trade secrets also include information that cannot be removed from Franchisee's knowledge and memory and that would inevitably be used and disclosed if Franchisee held interests in any competitive business; (b) Franchisor could not protect the trade secrets against unauthorized use or disclosure, could not readily assure compliance with Sections 6.1 through 6.2 if Franchisee held interests in any competitive business; and that (c) involvement by Franchisee in any competitive business would create a high level of temptation and opportunity to use Franchisor's trade secrets.

6.4. Exclusive Dealing. Franchisee acknowledges that Franchisor enters into this Agreement in consideration of, and reliance on Franchisee's agreement to deal exclusively with Franchisor and to refrain

from using any of Franchisor's trade secrets in any activity competitive with Franchisor, and to refrain from transferring the goodwill associated with the Marks to any other business. Therefore, during the term of this Agreement, Franchisee and, collectively and individually all directors, officers and holders of any direct or indirect beneficial ownership interest of five percent (5%) or more of the securities or other equity interests of Franchisee, or of any corporation, limited liability company, partnership or other form of entity affiliated with or directly or indirectly controlling or controlled by Franchisee, and each relative of each such person who is an individual, including each such person's mother, father, husband, wife, brother, sister, son or daughter (collectively "Covered Persons"), shall not have any interest as an owner, investor, partner, lender, director, officer, member, manager, employee, consultant, representative or agent or in any other capacity in any business selling Asian style foods, sushi or fresh fish products, steamed foods or any other retail food business without Franchisor's prior written consent. For 2 years after this Agreement expires without renewal or terminates, Franchisee and all Covered Persons shall not have any interest as an owner, investor, partner, lender, director, officer, member, manager, employee, consultant, representative or agent or in any other capacity in any business selling Asian style foods, sushi or fresh fish products, steamed foods or other food items developed or sold in the AFC System without Franchisor's prior written consent within:

A. 5 miles of any food service counter operated by Franchisor or by any franchisee or licensee or other affiliate of Franchisor in a major city (as defined below);

B. 10 miles of any food service counter operated by Franchisor or by any franchisee or licensee or other affiliate of Franchisor in a metropolitan area (as defined below);

C. 15 miles of any food service counter operated by Franchisor or by any franchisee or licensee or other affiliate of Franchisor in a rural area (as defined below).

D. For this Agreement, a "major city" means any of the top 25 cities in the U.S. measured by population; a "metropolitan city" means any city other than a major city where the population density is greater than 1,000 people per square mile; and a "rural area" means an area whose population density is 1,000 people per square miles or less. These figures shall be measured at the time of expiration or termination.

E. On written request from Franchisee, Franchisor will provide Franchisee a list of locations within a reasonable geographic area, to assist Franchisee in complying with this obligation.

6.5. Exceptions. The restrictions in Section 6.1 through 6.4 shall not apply to ownership of (a) securities listed on a stock exchange or traded on the over the counter market that represent two percent (2%) or less of the number of shares of the class of securities issued and outstanding; or (b) other food service counters that Franchisee has an interest in pursuant to a written agreement with Franchisor.

6.6. Separate Covenants. Each of the covenants in Sections 6.1 through 6.4 and each portion thereof, shall be construed as independent of any other covenant or provision. If all or any portion of a covenant is unenforceable due to its scope in terms of geography, duration, or activity covered or otherwise, but could be enforced if reduced in scope, then the parties agree to be bound by any lesser covenant subsumed within the terms of such covenant imposing the maximum duty permitted by law, as if the resulting covenant were separately stated in and made a part of the applicable provision within Sections 6.1 through 6.4.

7. System Changes.

7.1. Changes by Franchisor. Franchisee acknowledges that periodically Franchisor may modify any aspect of the AFC System, including, but not limited to, as required by law. Franchisor reserves the right to expand food offerings available at Food Service Counter(s), including hot foods and other food types. Franchisor shall communicate modifications through the Manuals or other ways. Franchisee shall comply with all modifications that Franchisor makes from time to time, at Franchisee's expense.

7.2. No Changes by Franchisee; Improvements to the AFC System. Franchisee shall not modify or deviate from any aspect of the AFC System without Franchisor's prior written consent. Franchisee shall notify Franchisor in writing of any proposed improvement to the AFC System ("Improvement") and provide to Franchisor such information as Franchisor requests regarding the Improvement. Any Improvement to the AFC System made by Franchisee for any purpose will be deemed to be a "work made for hire" under U.S. copyright law for the benefit of Franchisor, and therefore, Franchisor shall own the intellectual property rights in and to the improvements and may use the same for any and all purposes. To the extent any Improvement does not qualify as a work made for hire, Franchisee hereby assigns those Improvements to Franchisor for no additional consideration and with no further action required. Franchisee shall sign all further assignments or instruments, as Franchisor may request to effectuate the parties' agreement hereunder. If Franchisee should fail to do so, Franchisee hereby appoints Franchisor as Franchisee's attorney-in-fact with full power and authority for the sole purpose of executing and filing all assignments and other instruments necessary to obtain title to the Improvements in the name of Franchisor. This appointment shall be deemed to be coupled with an interest and shall continue in full force and effect following the termination or expiration of this Agreement. Franchisor shall have the right to incorporate the Improvements into the AFC System and into any other businesses in which Franchisor or its Affiliates have an interest without compensation to Franchisee. If the foregoing provisions of this Section 7.2 are found to be invalid or otherwise unenforceable, Franchisee hereby grants Franchisor a worldwide, perpetual, non-exclusive, fully paid license to use and sublicense the use of the Improvement to the extent Franchisor's use or sublicense would, absent this Agreement, directly or indirectly infringe Franchisee's rights therein.

8. Advertising.

8.1. Approval. Franchisee shall submit to Franchisor for prior approval, all advertising and promotion that Franchisee proposes to use, whether for print, broadcast, electronic or other media (including on the Internet), as well as novelty items, signs and containers. Franchisee shall use those materials only after receiving Franchisor's written consent, and shall not use any material without first obtaining Franchisor's written consent. Franchisor may withhold or later revoke consent, or may condition consent on modifications or other restrictions. Delay by Franchisor to require compliance or cure does not waive Franchisor's rights under this Section 8.1.

8.2. Advertising Restrictions. Franchisor shall have the right to impose geographic and/or other restrictions on advertising that Franchisee conducts or proposes to conduct. Franchisee shall include trademark and copyright notices and notices of independent ownership in advertising as Franchisor requests from time to time.

8.3. Phone Directory. Franchisor shall have the right to require Franchisee to maintain a listing in local telephone directories, according to standards set by Franchisor.

8.4. Cooperative Advertising. Franchisor reserves the right, in the future, to designate a geographic region that includes Franchisee's Food Service Counter(s) and at least one other Zenshi/AFC/Wild Blue food service counter as a local, regional or national cooperative area, for the purpose of developing a cooperative program. Franchisee shall participate in and contribute its share to the cooperative

designated by Franchisor, as determined according to the cooperative's operating procedures. The cooperative shall operate according to written governing documents prepared by or consented to by Franchisor. Franchisor shall have the right to veto any decision of the cooperative. Franchisor shall have the power to form, change, dissolve or merge cooperatives, at Franchisor's discretion.

8.5. Grocery Store Objection. Franchisee shall not conduct any advertising that is objectionable to the owner or manager of the premises where the Food Service Counter is located.

8.6. Advertising Campaigns. Franchisor may conduct regional or national advertising campaigns, geotargeted marketing campaigns, or national news and weather campaigns, ("Advertising Campaigns"). In the event Franchisor conducts any such Advertising Campaigns, Franchisor shall have the right to bill Franchisee for the pro-rata share of such campaigns, pursuant to Section 9.18, Franchisor may absorb some of the cost for such advertising, but is not obligated to do so. Franchisor undertakes no obligation, in administering the Advertising Campaigns, to make expenditures for Franchisee that are equivalent or proportionate to its contribution, or to ensure that any particular Franchisee benefits directly or pro rata from marketing or promotion conducted with the Advertising Campaigns. Food Service Counters operated by Franchisor or Franchisor's affiliates may, but are not required to, contribute to the Advertising Campaigns. If they do, they may not be required to contribute in the same percentage as Franchisee and may stop contributing at any time without notice to Franchisee. Franchisor shall prepare an annual unaudited accounting of the expenditures of the Advertising Campaigns which will be provided to Franchisee upon Franchisee's written request.

9. Fees and Compensation.

9.1 Initial Fee. Franchisee shall pay to Franchisor Franchisor's then current initial franchise fee for each Full Time Location to be operated by Franchisee under this Agreement. The initial fee shall be specified in the applicable Full Time Location Addendum. Franchisee acknowledges that Franchisor does not currently charge initial fees for Part-Time or Self Service location(s), however, Franchisee must have at least one operating Full Time location to be granted rights to a Part Time or Self Service location. While Franchisor does not currently charge initial fees for Part Time and Self Service locations, Franchisor reserves the right to implement such fees in the future. Franchisee shall pay the initial fee(s) in a lump sum on signing each Full Time Location Addendum. The fee is deemed to be fully earned on signing each addendum, and is nonrefundable. There shall be no refunds or prorations if a location starts as a Full Time location and later is transformed into a Self Service or Part-Time location. However, if a location starts as a Self Service or Part-Time location and is transformed into a Full Time location, then Franchisee shall pay Franchisor's then current initial franchise fee for such Full Time location.

9.2. Customer Payments. Franchisee acknowledges that under the AFC System's initial structure, Franchisee shall not receive payments for sales of goods and services of the Food Service Counter(s); and that those payments will be made directly or indirectly from customers to the facility (for example, a grocery store) where the Food Service Counter(s) is/are located, which shall then direct all payments to Franchisor, less an amount to be retained by the facility owner, pursuant to the facility owner's separate agreement with Franchisor. Franchisee acknowledges that under the AFC System, all sales will be sold by and through cash registers owned or operated by the owner of the facility where the Food Service Counter(s) is/are located. Franchisee shall not make any sales through cash registers of Franchisee without prior written consent of Franchisor. Franchisor shall have the right, but no obligation, to modify this payment structure from time to time.

9.3. Payments to Franchisee. Franchisor shall return to Franchisee the percentage amounts stated in the applicable Franchise Addendums attached to this Agreement. Franchisor shall have the right to deduct all amounts owed by Franchisee to Franchisor from the payments to Franchisee provided for in the

applicable Franchise Addendum, or elsewhere, either as lump sum deductions or partial deductions made over time, until such deductions equal the full amounts owed to Franchisor. Franchisee acknowledges that Franchisor's sole responsibility shall be to remit to Franchisee the agreed commission percentage on amounts actually received from the facility owner. Franchisor shall have no responsibility to pay any commission to Franchisee on amounts not received from the facility owner. If Franchisor pays Franchisee's commission in any given month before receiving payment from the facility owner, and the facility owner does not pay Franchisor as required, Franchisee shall reimburse Franchisor the commissions paid. Franchisee shall reimburse Franchisor any amounts paid to Franchisee, that Franchisor discovers were paid in error. At Franchisor's discretion, Franchisor shall have the right (in lieu of Franchisee reimbursement) to withhold from future payments due to Franchisee such amounts paid in error. Franchisor shall send payments to Franchisee via direct deposit. Franchisee shall pay Franchisor's then current direct deposit fee for this purpose.

9.4. Payment Responsibility. Franchisee shall be solely responsible to pay when due all costs and expenses of the Food Service Counter(s), including but not limited to the purchase price of food items and inventory, utilities, employee compensation, sales and any other taxes imposed on, required to be collected, or paid on account of goods or services furnished by Franchisee. Franchisee acknowledges and agrees that if the facility owner, due to labor contracts or otherwise, requires Food Service Counter(s) employees to be employed directly by the facility owner, and Franchisor is asked to reimburse the facility owner for these employment costs, that Franchisor shall have the right to and shall deduct such payments from the amounts due to Franchisee pursuant to Section 9.3 of the Franchise Agreement.

9.5. Royalty. Franchisor shall have the right at any time to revise the AFC System so that Franchisee collects revenues from sales, and pays Franchisor royalties on a basis approximately equivalent in amount or rate to amounts or rates that Franchisor receives and retains pursuant to this Agreement. Any such revisions made from time to time shall be deemed to occur pursuant to this Agreement and shall not constitute a modification of the Franchise or of this Agreement.

9.6. Gross Sales. "Gross Sales" shall mean revenues derived from Franchisee's sales. Gross Sales does not include sales tax, credits or refunds.

9.7. Customer Satisfaction Fee. Franchisor shall have the right to assess Franchisee up to One Thousand Dollars (\$1,000) for each customer complaint received, whether the complaint has any merit or not. This fee is not a penalty but to compensate Franchisor for the efforts the Franchisor must take to address the complaint. Franchisor's assessment of the customer satisfaction fee shall not constitute a waiver by Franchisor of its rights to seek damages and/or other relief against Franchisee due to Franchisee's conduct.

9.8. Default Charge Fee. Franchisor shall have the right to assess Franchisee up to \$1,000 per violation of any term, obligation or requirement of the Manuals or this Agreement. Franchisor's assessment of this fee shall not constitute a waiver by Franchisor of its rights to seek damages and/or other relief against Franchisee arising from the violation.

9.9. Web and Data Charges. To gain access to Franchisor's website pages which enable Franchisee to submit purchase orders online, and obtain information on new products, product specifications and other information, updates to Franchisee's tablet data, and access to Franchisor's inventory tracking software, Franchisor shall charge Franchisee a monthly fee of up to \$100 per Food Service Counter operated by Franchisee.

9.10. Bankruptcy By Facility Owner. If the facility owner where Franchisee's Food Service Counter(s) is/are located files for bankruptcy, or other similar proceeding, Franchisor's sole responsibility shall be to remit to Franchisee the agreed percentage on amounts actually received from the facility owner.

Franchisor shall have no responsibility to pay any commission to Franchisee on amounts not received from the facility owner. If Franchisor pays Franchisee's commission in any given month before receiving payment from the facility owner, and the facility owner does not pay Franchisor as required, Franchisee shall reimburse Franchisor the commissions paid.

9.11 Early Termination Fee. If this Agreement or any Franchise Addendum is terminated and/or if Franchisee abandons any Food Service Counter before the end of the term of this Agreement, Franchisor shall have the right, in addition to all other rights and remedies available to Franchisor in law and/or equity, to assess Franchisee an early termination fee of \$1,500 for each location terminated and/or abandoned. Such fee shall be payable at the earlier of (1) the time Franchisee notifies Franchisor of the desire to terminate/abandon, or (2) actual termination or abandonment of any location. Franchisor's assessment of the early termination fee shall not constitute a waiver by Franchisor of its rights to seek damages and/or other relief against Franchisee due to the early termination and/or breach.

9.12 Administrative Fee. Franchisee shall reimburse Franchisor for Franchisor's costs and expenses in complying with tax levies and wage garnishments issued against Franchisee or Franchisee's owners, up to \$100 per garnishment/levy request.

9.13 Third Party Audits and Charges. Franchisee shall reimburse Franchisor for amounts paid by Franchisor to third parties (including, but not limited to, government agencies and facility owner(s)) for audits, inspections, fines and/or charges imposed or levied against the Food Service Counter, including food safety, facility audits and customer service.

9.14 Shipping Administrative Fee. Franchisor shall have the right to charge and Franchisee shall pay Franchisor's administrative charges, to ship products to Franchisee's Food Service Counter, in an amount up to two and one-half percent (2 ½%) of the purchase price. The administrative fee is in addition to actual shipping costs to ship products to Franchisee's Food Service Counter.

9.15 Account Broker Fee. If Franchisor pays a fee for the right to locate the Food Service Counter in the facility or store, Franchisee shall reimburse Franchisor for the amounts paid, not to exceed \$500 per quarter for each Food Service Counter subject to this fee.

9.16 Third-Party Delivery Fee. Franchisor may deduct from amounts owing to Franchisee any third-party delivery fees charged to Franchisor by the facility or store on account of purchases from the Food Service Counter. The third-party delivery fee charged to Franchisee will be in Franchisor's sole determination as follows: (i) the amounts charged to Franchisor by the facility or store on account of food delivered from the Food Service Counter or (ii) at Franchisor's discretion, Franchisor may agree to share a portion of the third-party delivery fee cost with Franchisee and deduct the agreed upon amount from the amounts due to Franchisee. Alternatively, the facility or store may charge the third-party delivery fee to Franchisee directly.

9.17 Local Store Marketing Expense. If the facility or store charges Franchisor for local marketing initiatives for the Food Service Counter, such as on-site advertisements, coupon offers, social media promotions, mailers and other advertising programs, Franchisor may deduct such amounts from amounts due to Franchisee.

9.18 Advertising Contribution Fee. Franchisor reserves the right to enter into Advertising Campaigns and to bill Franchisee for Franchisee's pro-rata share of such advertising (the "Advertising Contribution Fee"). Franchisor may absorb some of the cost for such advertising, but is not obligated to do so.

9.19 Extended Producer Responsibility Fee. If the state where Franchisee's Food Service Counter(s) are located requires Franchisor to pay a fee as a result of that state's regulation of paper, plastic and packaging (the "Extended Producer Responsibility Fee"), Franchisee shall reimburse Franchisor for the Extended Producer Responsibility Fee paid by Franchisor on account of Franchisee's Food Service Counter(s).

10. Accounting.

10.1. Recordkeeping. Franchisee shall maintain full, complete and accurate books, records and accounts of the sales and expenses of the Food Service Counter(s). Franchisee shall conform these records to any accounting system that Franchisor may prescribe in the Manuals or otherwise in writing. Franchisee shall retain all books and records relating to the Food Service Counter(s) for at least four years.

10.2. Reports. Franchisee shall provide Franchisor each week on or at other frequencies that Franchisor specifies from time to time, in the form approved by Franchisor, a report of sales for the week ending the prior day (Sunday). Franchisee shall provide Franchisor at frequencies that Franchisor requests, profit and loss statements and balance sheets for months, quarters and years, all as Franchisor specifies. These financial statements shall be certified to be true and correct by Franchisee. Franchisee shall provide Franchisor copies of all federal and state income tax returns and sales tax returns. Franchisee shall submit to Franchisor other periodic reports, forms and records as Franchisor requests from time to time.

10.3. Discrepancies. In any discrepancy between data as reported by Franchisee and as reported by the owner or lessee of the premises where the Food Service Counter is located, the data reported by the premises owner or lessee shall control. Franchisee shall notify Franchisor in writing within 30 days of receipt of the statement from the store premises of any alleged discrepancy. Franchisee shall have no right to seek adjustments for any discrepancy after such 30 day period.

10.4. Audit. Franchisor or its designated agents shall have the right at reasonable times to examine and copy books, records and tax returns of Franchisee. Franchisor shall also have the right, at any time, to have an independent audit made of books and records of Franchisee at Franchisor's expense. If an inspection reveals a discrepancy or underreporting of sales of one percent (1%) or more for any period, then Franchisee shall take corrective action, including but not limited to paying Franchisor the amounts that would have been paid but for any underreporting, all as Franchisor specifies; and interest at the rate of 1% per month (12% per year) from the date the amount would have been due until paid; and Franchisee shall, in addition, reimburse Franchisor for all costs and expenses connected with the inspection. These remedies shall be in addition to any other remedies Franchisor may have.

11. Training, Quality and Performance Standards.

11.1. Compliance with System/Reports. Franchisee shall comply with the Manuals and all other written policies provided to Franchisee by Franchisor. Franchisee shall not make any material changes to the operation or structure or facilities of the Food Service Counter(s) nor make any material replacement or alterations to equipment, fixtures, signs or decor without Franchisor's prior written consent. Franchisee shall submit to Franchisor such periodic reports, forms and records as Franchisor requests from time to time, including but not limited to, cleaning schedules, daily production reports, delivery logs, overnight rice cooling logs, pH logs, temperature logs and sushi cooling logs. Franchisee shall obtain and provide Franchisor an email address to which Franchisor may send written communications and sales reports to Franchisee.

11.2. Condition. Franchisee shall maintain the condition and appearance of the Food Service Counter(s) and all equipment consistent with Franchisor's standards. Franchisee shall maintain each Food

Service Counter in a high level of cleanliness and first class appearance, including but not limited to, replacing worn or obsolete signs, fixtures, decor and equipment. Franchisee shall repair, at Franchisee's sole cost and expense, any equipment and/or worn or obsolete signs, fixtures and décor. If at any time in Franchisor's judgment the appearance of a Food Service Counter or equipment, fixtures, signs or decor does not meet Franchisor's standards, Franchisor shall have the right to notify Franchisee, specifying the corrective action to be taken by Franchisee. Franchisee shall correct the deficiency within 15 days after receipt of the notice, or such shorter period of time that Franchisor reasonably requests, provided that any deficiency that Franchisor believes could threaten public health or safety shall be corrected immediately.

11.3. No Other Purpose. Franchisee shall not conduct any business or activity from the location(s) of the Food Service Counter(s) other than the operation of the Food Service Counter according to the AFC System. All food items prepared at the Food Service Counter shall be sold at the Food Service Counter only and at no other location without the prior written consent of Franchisor. Under no circumstances are the premises of the Food Service Counter to be used for the preparation of food items to be sold other than on the premises, except Franchisee may prepare and deliver prepared foods to Self Service locations owned by Franchisee, if operated pursuant to an addendum to this Agreement.

11.4. Proprietary Products. Franchisor has developed and may continue to develop other proprietary food products, sauces and spices. To protect Franchisor's trade secrets and maintain quality control, Franchisor shall have the right to require Franchisee to purchase such proprietary items only from Franchisor or third parties that Franchisor designates.

11.5. Full Menu. Franchisee shall offer for sale and sell at the Food Service Counter(s) all food items that Franchisor authorizes from time to time; and shall not offer for sale or sell at the Food Service Counter(s) any other category of products. Franchisee shall have the right to offer additional prepared food items from time to time on a special or market test basis, provided that Franchisee shall notify Franchisor in writing at least 30 days in advance and shall comply with any request by Franchisor to refrain from offering any one or more such items.

11.6. New Products. From time to time, Franchisor may introduce new products, or reintroduce previously introduced new products. Franchisee shall purchase, maintain and display reasonable inventories of such new products for at least 120 days. Franchisor may require Franchisee to again purchase, maintain and display the products regardless of prior compliance with this section 11.6. Franchisee shall not introduce, offer or sell any new items that have not been approved by franchisor in writing.

11.7. Samples. Franchisee shall comply with sampling policies that Franchisor establishes from time to time. These may include requirements to provide free samples to customers and potential customers.

11.8. Preparation. To ensure that all items produced by Franchisee meet Franchisor's standards, and to protect Franchisor's goodwill and Marks, all food products shall be prepared only by properly trained personnel according to Franchisor's recipes, preparation techniques and processes as designated in the Manuals, and shall be sold only at retail to customers in conformity with Franchisor's marketing plan and concept.

11.9. Proposed Suppliers. If Franchisee proposes to offer at the Food Service Counter(s) any brand of product, or to use any item not then approved by Franchisor or to purchase from a supplier not then designated by Franchisor as an approved supplier, Franchisee shall first notify Franchisor and on Franchisor's request, submit samples and other information that Franchisor requires for examination and/or testing or to otherwise determine if the product, or proposed supplier meets Franchisor's specifications and quality standards. Franchisee shall pay Franchisor a reasonable charge for the cost of inspection and evaluation, including a reasonable amount for Franchisor's costs of personnel to conduct the inspection and

evaluation. Franchisor reserves the right to re-inspect facilities and products of any supplier and to revoke approval of any item that does not continue to meet Franchisor's standards. Franchisor reserves the right to approve any and all supplies, suppliers, brands and other products and services, whether currently approved or submitted for approval.

11.10. Suppliers. From time to time, Franchisor may provide Franchisee a list of approved products, brands, and/or suppliers for food products and other items necessary to operate the Food Service Counter(s), identifying manufacturers, brands, suppliers, transportation companies, and products and services that Franchisor has approved to be carried or used in the AFC System. Franchisor may revise the list from time to time. If Franchisee wishes to purchase a product or use a supplier not on the list, Franchisee shall submit Franchisee's request in writing to Franchisor before making any purchase and shall pay Franchisor's then current fees, costs and expenses to investigate the product or supplier. Franchisor is not under any obligation to approve the requested product or supplier and Franchisee shall comply with Franchisor's decision. Franchisor shall have the right to revoke any approval previously given.

11.11. Use of Approved Items. All goods and services used in operating the Food Service Counter(s) that are not specifically required to be purchased according to Franchisor's approved suppliers list, shall conform to specifications and standards that Franchisor establishes from time to time. Franchisee shall also comply with any source restrictions imposed by the facility owner to maintain quality control or an identifiable source for products in the event of product recalls.

11.12. Inventory. Franchisee shall always maintain an inventory of food and other products, materials and supplies to permit operation of the Food Service Counter(s) at maximum capacity.

11.13. Private Label. Franchisor may develop proprietary or private-labeled products for the Food Service Counter(s). To monitor the manufacture, packaging, processing and sale of these products Franchisor shall: (a) manufacture, supply and sell the proprietary or private labeled products to franchisees; and/or (b) disclose the designs or specifications of these products to a limited number of suppliers who Franchisor will authorize to make them to Franchisor's specifications and to sell them to franchisees. Franchisee acknowledges that Franchisee shall be required to purchase the proprietary or private labeled products from Franchisor, or from a limited number of suppliers designated by Franchisor.

11.14. Charges for Purchases. From time to time Franchisee may purchase food and other items from Franchisor or Franchisor's Affiliate. Franchisor shall have the right to charge, and Franchisee shall pay, freight, and other ancillary charges for such items, as well as Franchisor's and/or Franchisor's Affiliate's prices for such items. Franchisor shall have the right to deduct product purchases from payments owed to Franchisee.

11.15. Product Purchases.

(a) Franchisee shall reimburse Franchisor and/or Franchisor's Affiliate for product purchases from third party suppliers shipped to Franchisee on Franchisee's behalf.

(b) For Franchisee's convenience, Franchisor may ship routine shipments of products, including but not limited to, ingredients, product supplies and retail items, to Franchisee for use at the Food Service Counter(s). Franchisee may cancel such shipment(s) by providing Franchisor written notice of Franchisee's desire to do so at least one week prior to the scheduled delivery date.

11.16. Licenses. Franchisee shall obtain and maintain all required licenses, permits and certificates needed to operate the Food Service Counter(s) and provide copies of such licenses and permits to Franchisor. At Franchisor's election, Franchisor shall have the right, but no obligation, to obtain any required licenses

and permits in Franchisee's name. Franchisee hereby grants Franchisor a power of attorney to apply for any required licenses, permits and any renewals of these for Franchisee's Food Service Counter(s). Franchisee shall reimburse Franchisor for any costs and fees incurred by Franchisor in applying for these licenses and/or permits on Franchisee's behalf. Franchisee shall operate the Food Service Counter(s) in full compliance with all applicable laws, ordinances and regulations, including but not limited to health, safety and sanitation laws.

11.17. Personal Involvement. Franchisee, or Franchisee's manager, or if Franchisee is an entity, Franchisee's principal owner (or such other person/manager), shall participate in day-to-day operation of the Food Service Counter(s), and shall directly supervise the operation of the Food Service Counter(s) and its employees. If Franchisee operates more than one location, then at least one trained employee with ServSafe Manager certification shall act as manager for those other locations. To assure Franchisor is aware of whom to contact in the event of Franchisee's absence, Franchisee shall provide to Franchisor a written list of every manager employed by Franchisee. Franchisee shall update and provide a revised manager list to Franchisor in writing within 24 hours of: (1) any new manager being hired; and/or (2) any manager leaving Franchisee's employment. Franchisee shall abide by lawful requests of the business owner or manager of the premises regarding any employee or prospective employee. Before start of employment, Franchisee shall train each manager and require each manager to sign a confidentiality and non-disclosure agreement in a form satisfactory to Franchisor requiring the manager to protect Franchisor's trade secrets and any other item Franchisor specifies in writing from time to time. Franchisee shall ensure each manager is trained before start of employment.

11.18. Uniforms. Franchisee shall purchase and Franchisee's employees shall at all times wear uniforms imprinted with the Marks and conforming to other specifications prescribed by Franchisor.

11.19. Computer and Software Requirements. Franchisee shall purchase a computer system meeting Franchisor's specifications with Internet connectivity capabilities to permit Franchisee to submit purchase orders online and to obtain information on new products, product specifications and other information Franchisor designates from time to time. Franchisee shall be solely responsible for the computer system, including maintaining and repairing it when necessary. Franchisor may require Franchisee to provide Franchisor independent access to the information generated or stored on Franchisee's computer system. Franchisee shall keep the computer system current. Franchisor may, in the future, develop or designate additional and/or alternate hardware and/or software for performing various functions for the Food Service Counter(s). Franchisee shall implement and use the hardware and software in operating the Food Service Counter(s) and comply with all standards prescribed by Franchisor regarding such hardware and software.

11.20. Tablet and Inventory Scanner. Franchisee shall purchase a tablet, inventory scanner and printer ("Tablet System") meeting Franchisor's specifications with Internet connectivity capabilities to permit Franchisee to print labels, track daily products made at the Food Service Counter(s) and conduct other functions prescribed by Franchisor. Franchisee shall be solely responsible for the Tablet System, including maintaining and repairing it when necessary. Franchisor may require Franchisee to upgrade and/or update the Tablet System and to provide Franchisor independent access to the information generated or stored on Franchisee's tablet, including inventory tracking logs. Franchisee shall keep the Tablet System current. Franchisor may, in the future, develop or designate computer application software for use with the Tablet System for performing various functions for the Food Service Counter(s). Franchisee shall purchase, implement and use the software in operating the Food Service Counter(s) and comply with all standards prescribed by Franchisor regarding the software, including upgrade and maintenance requirements.

11.21. Quality. Franchisee shall use only fresh ingredients and products of the highest quality, as determined by Franchisor in its reasonable discretion.

11.22. Operating Hours; Staffing. Franchisee or Franchisee's approved manager shall operate each Food Service Counter every day that the location where the Food Service Counter is located is open for business and subject to any additional requirements in any applicable Franchise Addendum attached to this Agreement. Franchisee shall ensure each Food Service Counter is adequately staffed and managed. In locations operated by a manager, Franchisee shall remain personally and actively involved in the Food Service Counter(s) operations and shall remain responsible for operating the Food Service Counter(s) and supervising employees. The personnel Franchisee retains to work at Franchisee's Food Service Counter(s) shall be Franchisee's agents and employees and Franchisor shall not be a joint employer of those persons. Franchisee alone shall determine who to retain, how many personnel to retain (subject to any minimum staffing requirements Franchisor may prescribe), compensation terms, employment terms and working conditions for Franchisee's personnel, and when and how to discipline or terminate the employment of Franchisee's personnel.

11.23. Store's Rules. Franchisee shall comply with the rules, policies and guidelines of the facility where the Food Service Counter(s) is/are located and sign any code of conduct or equivalent document required by the facility owner. If required by the facility owner, Franchisee shall obtain proof of employability for each prospective employee by completing the Department of Homeland Security's electronic employee verification system (E-Verify) before hiring.

11.24. Complaints. Franchisee shall promptly notify Franchisor in writing of any complaints from the owner(s) or manager(s) of the facility where any Food Service Counter is located, or from the public of problems relating to operation of the Food Service Counter or its products. Franchisee shall be primarily responsible to resolve and remedy all complaints to the satisfaction of the complaining person or entity.

11.25. Pricing. Franchisor may recommend resale prices or pricing schedules to Franchisee and may provide pricing labels conforming to these recommendations. Franchisee shall have the right to determine prices that Franchisee charges for products sold from the Food Service Counter(s). If Franchisee desires to charge a price or prices that differ from a price or price schedule recommended by Franchisor, then Franchisee shall pay or reimburse any additional reasonable costs that Franchisor incurs to prepare price labels containing the pricing determined by Franchisee. When allowed by law, Franchisor shall have the right to specify maximum and minimum prices for products sold at the Food Service Counter(s), and Franchisee shall abide by these specifications.

11.26 Initial Training. Franchisor shall provide Franchisee on one occasion, an initial training program in Franchisor's methods and techniques to prepare fresh sushi and/or other products and to operate a retail food service counter. If Franchisee is an entity, each of Franchisee's Principal Owners, shall be required to attend training. For this Section 11.26, the term "Principal Owner" shall mean any individual owning directly or indirectly thirty percent (30%) or more of Franchisee. The training program shall take place at Franchisor's headquarters, online or other location that Franchisor designates. The training program shall include classroom and on-the-job training and cover various aspects of the operation of a retail food service counter, with emphasis on techniques and examples used in the operation of food service counters bearing the Marks. Topics to be covered may include, but are not limited to legal compliance, sanitation, sushi and other food preparation and evaluation, steam table menu, cooking and evaluation (if applicable to the franchise), franchise management, including, basic accounting, operations, business insurance, inventory control, employee management, marketing, license and permitting requirements. Before starting operations, Franchisee and Franchisee's manager shall also take and pass the ServSafe Manager certification offered by Franchisor and the ServSafe Allergen Awareness Training provided online by ServSafe. Franchisor shall have the right to reduce the scope of any training provided, if Franchisor, in its sole discretion, determines that Franchisee already has experience in these subjects. Each person attending Franchisor's training program(s) shall pay Franchisor's then current fee for this training. Franchisee shall be solely responsible for all travel and living expenses incurred for Franchisee, Franchisee's Principal Owners and other staff

Franchisee elects to send to the training program. If Franchisee or any owner of Franchisee attending the training fails to complete the training to Franchisor's satisfaction, Franchisor may cancel this Agreement in Franchisor's sole judgment on written notice to Franchisee. There shall be no refunds of any sums paid to Franchisor if Franchisor cancels this Agreement under this Section 11.26. Franchisor reserves the right to waive the training requirement in Franchisor's absolute discretion where Franchisor is satisfied that Franchisee or Franchisee's principals have sufficient skill, knowledge and experience with both the operational requirements and Franchisor's prescribed and preferred procedures. Franchisor may also exempt Franchisee from some or all training (at Franchisor's sole discretion) if Franchisee or any affiliate of Franchisee already owns or operates a Food Service Counter or the Franchise Agreement is executed as a Renewal Franchise Agreement (as defined in Section 13.1). Franchisee acknowledges that all training is provided to protect the AFC System and the Marks and not to control the day-to-day of Franchisee's operations.

11.27 Post Opening Training. For Franchisee's initial location only, Franchisor shall provide Franchisee up to 3 days training at Franchisee's location. Franchisor shall not charge a fee for this post opening training. If Franchisee asks, or Franchisor decides that additional post opening training is needed, Franchisor shall have the right to charge its then current fee per additional day of training provided.

11.28. Additional Training. From time to time Franchisor may require Franchisee or Franchisee's manager to attend and satisfactorily complete additional training programs at Franchisor's headquarters, online or other location designated by Franchisor. Franchisor shall have the right to charge Franchisee Franchisor's then current fee for each person for whom Franchisor provides any additional training, even if that training was required by Franchisor. Franchisee shall be solely responsible for all travel and living expenses incurred to attend any training programs. If Franchisee fails to attend any mandatory additional training, Franchisor shall have the right to assess Franchisee a \$250 penalty for the failure to attend. Franchisee acknowledges that all training is provided to protect the AFC System and the Marks and not to control the day-to-day of Franchisee's operations.

11.29 Mailing, Reproduction Costs and Handling Costs. Franchisor may charge Franchisee a reproduction, service and handling charge for written materials provided to Franchisee, such as manuals and marketing materials up to \$100 per shipment.

11.30 Testing and Criminal Background Checks. Whenever requested by Franchisor or the facility owner where Franchisee is located, Franchisee shall require specified personnel (which may also include Franchisee), to undergo drug, tuberculosis and other chemical and disease testing and/or criminal background investigation. The foregoing obligations are subject to the condition that the request is lawful in the jurisdiction where the Franchisee and Franchisee's personnel are located. Franchisee shall pay all costs of the testing and investigation, complete all forms and consents, and take all other action needed to comply with such request. If Franchisee fails any required test or background check, Franchisor may cancel this Agreement on written notice to Franchisee. There shall be no refunds of any sums paid to Franchisor if Franchisor cancels this Agreement under this Section 11.30.

11.31 Operational Communications. Franchisee agrees to receive notices and other communications from Franchisor on operations, recalls and other emergency communications via all available means, including, but not limited to, telephone calls, text messages, emails, instant messaging and other then current modes of communication.

11.32 Franchisee's Demeanor. Franchisee shall at all times act professionally and respectfully in dealing with customers, clients, the facility's personnel and Franchisor's employees.

12. Risk Management.

12.1. Insurance. Franchisee shall obtain and maintain in effect all the following insurance coverage through insurance companies satisfactory to Franchisor for each location operated by Franchisee:

(a) Commercial General Liability coverage covering the premises and Franchisee's operations for bodily injury and property damage liability including contractual liability, personal injury and product liability coverage in amounts not less than \$1,000,000 per occurrence and \$2,000,000 aggregate;

(b) Worker's Compensation Insurance in statutory amounts as required in the state(s) where Franchisee's operations are conducted, including a Voluntary Worker's Compensation endorsement extending coverage to all employees exempted from coverage due to numerical employment requirements of the state;

(c) Employer's Liability Insurance with limits of \$1,000,000 per occurrence;

(d) Unemployment Insurance covering Franchisee's employees;

(e) Property Insurance in an amount adequate to replace contents in the event of an insured loss;

(f) Business Income Insurance with limits adequate to insure profits and continuing business expenses for one year;

(g) State disability insurance for Franchisee's employees (as required by law); and

(h) Automobile liability insurance including coverage for autos owned, leased, hired or borrowed by Franchisee or Franchisee's owners, with limits of at least five hundred thousand dollars (\$500,000) per occurrence of bodily injury and property damage combined, and any other or increased amounts of insurance that Franchisor may require from time to time for each vehicle used by Franchisee (whether principally or occasionally) in connection with the franchised business (for example, to drive to the franchised location(s), to deliver products to self service locations, or otherwise).

These coverages shall name Franchisor, Franchisor's parent and the facility owner where Franchisee operates as additional insureds (using such endorsements and endorsement forms approved by Franchisor); the additional insured must be primary and non-contributory; and the coverages must provide that Franchisor is entitled to receive at least 30 days prior written notice of any intent to reduce coverage or policy limits, cancel or otherwise amend the policy.

12.2. Changes. Franchisor shall have the right from time to time to establish and revise the minimum coverages, coverage amounts and required policy terms that Franchisee is required to obtain and maintain. Promptly after delivery of written notice to Franchisee of any revisions, Franchisee shall obtain and thereafter maintain insurance conforming to the revised requirements.

12.3. Proof. Franchisee shall provide Franchisor within 30 days of the date of this Agreement, certificates of insurance proving the coverages required above as well as a copy of Franchisee's insurance declaration pages with all endorsements. Franchisee shall deliver a complete copy of Franchisee's then prevailing insurance policies within 30 days after delivery of the certificates of insurance. Immediately on renewal or the purchase of replacement insurance, Franchisee shall deliver to Franchisor a certificate of insurance and declaration pages for the new or renewal policy.

12.4. Failure to Maintain. If Franchisee fails to purchase and maintain insurance required by Section 12.1 then Franchisor will have the right, but no obligation, to obtain that insurance through agents and insurers Franchisor chooses, or other insurance that Franchisor is able to obtain for such purpose. Franchisee shall, at Franchisor's election, pay all premiums for such insurance or reimburse premium payments made by Franchisor. Franchisor will also have the right to offset the amounts of those premiums against any amounts due from Franchisor to Franchisee. Franchisee hereby grants Franchisor a power of attorney to obtain any required insurance and any renewals thereof on Franchisee's behalf.

12.5. Insurance Disclaimer. Franchisor has no obligation to obtain or maintain any insurance for or on behalf of Franchisee.

12.6. Indemnity. Franchisee shall defend, indemnify and hold harmless Franchisor, Franchisor's affiliated entities, and the owner(s) and lessee(s) of the location(s) where the Food Service Counter(s) is/are located, and each of their respective members, shareholders, managers, partners, directors, officers, employees, agents, and representatives and other personnel (collectively "Indemnified Parties") from all losses, costs and expenses incurred in connection with any claim, action, suit or other proceeding or government demand (including any state and/or federal agency imposed charges, fines, penalties and taxes), based on actual or alleged acts or omissions of Franchisee, Franchisee's personnel, or others, arising from or related to the operation of the Food Service Counter(s). Franchisee shall also defend, indemnify and hold harmless the Indemnified Parties from any liability or claims by Franchisee's employees against the Indemnified Parties for wage and hour and/or other labor and employment law violations arising from such employees' employment or work at the Food Service Counter(s).

12.7. Disclaimers. The parties acknowledge that this Agreement pertains to establishing and operating food service counter(s) where Franchisee will make prepared food products for sale to the public; and is not a vending machine, rack, display case or amusement machine business.

13. Renewal.

13.1. Renewal. If Franchisee fully complied with all conditions to renewal in Sections 13.2 through 13.3, and if this Agreement has not previously terminated, then Franchisee shall have the right, but no obligation, on expiration of this Agreement, to enter into a renewal Franchise Agreement (the "Renewal Agreement") for one consecutive term of five years (the "Renewal Term"). Each of the conditions stated in Sections 13.2 through 13.3 shall be conditions precedent to Franchisee's right to enter into a Renewal Agreement.

13.2. Conditions to Renewal. As conditions to the right to enter into a Renewal Agreement, Franchisee shall have (a) complied with all provisions of this Agreement and any applicable Addendum during its entire term, including the time when Franchisee gives notice of intent to renew; (b) the ability to maintain possession of all Food Service Counter locations operated by Franchisee under this Agreement; (c) brought the Food Service Counter(s) into full compliance with the specifications and standards then applicable for new or renewing Zenshi/AFC/Wild Blue Food Service Counters; (d) given written notice of renewal to Franchisor as provided in Section 13.3; (e) signed Franchisor's then-current form of Franchise Agreement and applicable addendum(s) at least 30 days before the expiration date (with appropriate modifications to reflect the fact that the Franchise Agreement relates to the grant of a renewal franchise), and that agreement shall supersede this Agreement. The terms of that Agreement may differ materially from the terms in this Agreement including, without limitation, different payment amounts or arrangements; (f) complied with Franchisor's then-current qualifications and training requirements; and (g) paid a non-refundable renewal fee which shall equal Franchisor's then current initial franchise fee charged by Franchisor to new franchisees for each location to be renewed. Franchisee's failure to provide the notice in

Section 13.3 or otherwise comply with each obligation under this Section 13.2 by the applicable deadline shall be deemed Franchisee's desire not to renew this Agreement.

13.3. Notice. If Franchisee desires to enter into a Renewal Agreement, then before expiration of this Agreement, Franchisee shall give Franchisor written notice of its desire at least 180 days but not more than 360 days prior to the expiration of the initial term of this Agreement. Renewal shall also be conditioned on Franchisee's compliance with this Agreement through termination of the initial term and Franchisee retaining all Food Service Counter locations operated by Franchisee under this Agreement.

13.4 Month-to-Month. If Franchisee does not sign Franchisor's then-current Franchise Agreement prior to the expiration date and Franchisee continues to accept the benefits of this Agreement after it expires, then at Franchisor's option, this Agreement may be treated either as (i) expired as of the expiration date with Franchisee then operating without a license to do so and in violation of Franchisor's rights; or (ii) continued on a month-to-month basis ("Month-to-Month Agreement") until one party provides the other with written notice of such party's intent to terminate the Month-to-Month Agreement, in which case the Month-to-Month Agreement will terminate thirty (30) days after receipt of the notice to terminate the Month-to-Month Agreement, or such longer notice period as is required by Applicable Law. In the latter case, all of Franchisee's obligations shall remain in full force and effect during the Month-to-Month Agreement as if this Agreement had not expired, and all obligations and restrictions imposed on Franchisee upon expiration of this Agreement shall be deemed to take effect upon termination of the Month-to-Month Agreement.

14. Transfer Restrictions.

14.1. Assignment by Franchisor. Franchisor shall have the right to transfer or assign any or all rights and obligations under this Agreement in whole or in part, on one or more occasions, to any person, corporation or other entity.

14.2. Assignment by Franchisee. Franchisee acknowledges that Franchisor entered into this Agreement and each Franchise Addendum in reliance on characteristics personal to Franchisee, Franchisee's principal owners and officers, and personal to the entity constituting Franchisee. Therefore, Franchisee shall have no right or power to, and shall not purport to sell, transfer, assign, sublicense, give, mortgage, pledge or encumber any interest in this Agreement, in any Franchise Addendum, in the business contemplated by this Agreement, or if Franchisee is an entity, a majority of the shares of stock or ownership interests in that entity (collectively, "Transfer"), without the prior written consent of Franchisor. Franchisor shall have the right to withhold consent to any sale or transfer proposed to be entered into within 2 years of the date of the applicable addendum for the location proposed to be sold or transferred. Franchisor shall also have the right to withhold approval to any proposed sale or transfer, at Franchisor's discretion, if such sale or transfer involves the sale/transfer of some but not all of Franchisee's locations operated under this Agreement.

14.3. Entity Documents. If Franchisee or any assignee of Franchisee is an entity, then Franchisee and the assignee shall provide Franchisor a copy of its charter documents (operating agreement, regulations, articles of incorporation; partnership agreement, bylaws; and other governing documents designated by Franchisor), list of owners including the ownership interest of each, managers, directors and officers, all amendments to these documents, and all other information about the organization, structure and personnel that Franchisor requests from time to time. Franchisee shall promptly notify Franchisor in writing of any change in any information provided under this Section 14.3.

14.4 Notice of Restrictions. Franchisee shall place on the face of each certificate, agreement and other instrument evidencing ownership of the entity constituting Franchisee, the following statement in conspicuous typeface:

The transfer of the interest in [name of Franchisee] evidenced by this certificate [or instrument] is subject to the terms of a Franchise Agreement with Advanced Fresh Concepts Franchise Corp. dated [state date of this Agreement]. Any purported transfer made without complying with those terms is void and of no effect.

14.5 Transfer to Entity. Franchisor will not unreasonably withhold consent to a written request by Franchisee to transfer/assign Franchisee's interest in this Agreement to a corporation, limited liability company or equivalent entity, provided that Franchisee satisfies all the following conditions precedent: (a) the entity is newly organized and its activities will be limited to acting as an AFC franchisee; (b) the entity's name shall not include the words "Zenshi," "AFC," "Advanced Fresh Concepts," "Wild Blue," "Southern Tsunami," "Hybrid Sushi" or any variant, or words confusingly similar thereto without Franchisor's prior written consent; (c) Franchisee shall be the sole owner of at least 51% of the ownership of the entity and any remaining ownership is owned only by Franchisee's spouse or children; (d) if Franchisee is two or more individuals, then each owns the same percentage of the entity as his or her interest in the business prior to the transfer/assignment; (e) the entity's articles of incorporation, articles of organization and bylaws state that the issuance and transfer of any interest in the entity are restricted by this Agreement; (f) all the entity's ownership certificates provide the notice stated in Section 14.4; and (g) Franchisee pays Franchisor's then current transfer to entity fee. A transfer/assignment made pursuant to this Section 14.5 shall not be subject to Franchisor's rights of first refusal in Section 14.6 of this Agreement.

14.6. Right of First Refusal. Franchisor shall have a right of first refusal itself to accept the terms of any sale, transfer or assignment of any interest in any Food Service Counter operated by Franchisee, this Agreement or in Franchisee, offered by Franchisee or offered to and proposed to be accepted by Franchisee, whether voluntarily, by operation of law or otherwise. If Franchisor exercises the right of first refusal, then Franchisor will also have the right but no obligation to substitute cash for any form of payment proposed in the offer; and will have 60 days after notifying Franchisee of its election to exercise the right of first refusal to prepare for closing. If a proposed transaction would involve more than 20% of the stock or other ownership interest of Franchisee then Franchisor will also have the right, but no obligation, to purchase not only the interest involved but also all the remaining interests, to acquire up to 100% of the interest in Franchisee, at a price proportionate to the price of the interests initially involved. If Franchisor exercises the right of first refusal, then at Franchisor's request, Franchisee shall also take all action necessary to cause the lease for the location(s) affected, and any other agreements designated by Franchisor, to be assigned to Franchisor.

14.7. Exercise of First Refusal. To provide Franchisor the opportunity to exercise the right of first refusal, Franchisee shall deliver to Franchisor a written notice stating all the terms of any proposed sale, transfer or assignment covered by the right of first refusal and shall provide any additional information that Franchisor requests about the proposed transaction. Franchisee shall require its owners to provide Franchisee sufficient information to enable Franchisee to comply with this obligation with regard to a transaction proposed by any of the owners of Franchisee. Within 45 days after Franchisor receives the notice and the additional information requested by Franchisor, Franchisor will notify Franchisee whether Franchisor accepts for itself or its nominee the terms in the notice.

14.8. Waiver. If Franchisor elects not to exercise the right of first refusal and consents to the proposed sale, assignment or transfer, then Franchisee will be authorized to complete the proposed transaction with the proposed assignee on the terms in the original notice to Franchisor. Any change to the terms constitutes a new proposal which again requires compliance with the procedures in Sections 14.6 through 14.7 (and this Section 14.8, if applicable). Franchisor's election not to exercise the right of first refusal for any proposed transaction does not affect Franchisor's right of first refusal for any other transaction and does not constitute approval of the proposed transferee or assignee or of the transaction.

Franchisee and any proposed transferee or assignee shall comply with all provisions in this Agreement relating to transfer and assignment.

14.9. Sale To Third Party. If Franchisor elects not to exercise the right of first refusal, then Franchisor's consent to a proposed sale, transfer and/or assignment by Franchisee shall not be unreasonably withheld. It shall be deemed to be reasonable for Franchisor to require, as conditions precedent to consenting to the proposed sale, transfer and/or assignment, among other requirements, that (a) Franchisee first comply with the right of first refusal provisions in Sections 14.6 through 14.7; (b) the proposed transferee/assignee apply to Franchisor to become a franchisee; provide information that Franchisor requests to assess the proposed transferee's/assignee's skills, qualifications, integrity, honesty and resources (financial and otherwise) sufficient in Franchisor's judgment to operate the Food Service Counter(s) in a manner that Franchisor expects to be satisfactory; (c) the proposed transferee/assignee cooperates in arranging one or more personal interviews at times and places designated by Franchisor; (d) consent is obtained, of the owner(s) of the location(s) where the Food Service Counter(s) is/are located if such owner(s) has/have the right to consent pursuant to an agreement with such owner; (e) the proposed transferee/assignee attends and successfully completes Franchisor's initial training program and any other training Franchisor requires, all at the proposed transferee's/assignee's expense; (f) at Franchisor's option, the proposed transferee/assignee, either: (i) signs Franchisor's then current form of Franchise Agreement, modified to delete any initial fee, and to expire on the expiration date of this Agreement or (ii) signs Franchisor's then current form of Franchise Agreement for a full term and pays Franchisor's then current initial franchise fee; (g) Franchisee pays all moneys owed to Franchisor and to any affiliated entities of Franchisor and in addition pays Franchisor a transfer fee of \$1,500 for each location to be transferred; (h) Franchisee and the principal owners of Franchisee execute a general release in a form satisfactory to Franchisor of all claims against Franchisor, its owners, directors, officers, members, managers and employees; (i) Franchisee agrees not to retain any security interest in any assets of the franchise or business following the transfer; (j) that the terms of the sale and/or assignment not be unduly burdensome to the transferee/assignee in Franchisor's judgment; and (k) that the sale, transfer and/or assignment close within 90 days of Franchisor's election not to exercise the right of first refusal.

14.10. Transfer On Death or Incapacity. If Franchisee is an individual who dies, or becomes permanently incapacitated, then Franchisor shall allow the deceased's surviving spouse, heirs, or estate or the incapacitated person's legal representative, the opportunity to participate in ownership of Franchisee during 180 days after the death or incapacity, provided that during that time the surviving spouse, heirs or estate or legal representative (a) maintains all standards of the franchise, performs all obligations of Franchisee and satisfies all then current qualifications for a purchaser of a franchise or, (b) in accordance with the requirements of Sections 14.2 and 14.6 through 14.9 sells that person's ownership interest in Franchisee and the Food Service Counter(s) to a person who satisfies Franchisor's then current standards for new franchisees.

14.11. Death or Incapacity of Individual Affiliated with Entity. If Franchisee is an entity, then the death or incapacity of a shareholder, owner, director, manager, officer or partner of Franchisee shall not constitute an assignment or transfer of this Agreement under Section 14.2, provided that during 180 days after the death or incapacity the surviving spouse, heirs or estate or the incapacitated person's legal representative (a) maintains all standards of the franchise, performs all obligations of Franchisee and satisfies all then current qualifications for a purchaser of a franchise or, (b) in accordance with the requirements of Sections 14.2 and 14.6 through 14.9 sells that person's ownership interest in Franchisee and the Food Service Counter(s) to a person who satisfies Franchisor's then current standards for new franchisees.

14.12. Operation by Franchisor. From the date of death or incapacity until satisfied that a qualified and trained individual assumed full-time operational supervision of the Food Service Counter(s), Franchisor shall have the right, but no obligation, to enter and operate the Food Service Counter(s). Any decision by

Franchisor to do so shall be deemed to be an accommodation to assist Franchisee. Franchisor makes no representation or warranty regarding its ability to operate the Food Service Counter(s) profitably, and Franchisor shall not be responsible for results of operation. Franchisee shall reimburse all Franchisor's expenses incurred to operate the Food Service Counter(s) pursuant to this Section 14.12, including but not limited to travel, lodging, meals, and personnel compensation; and shall pay Franchisor, in addition to all other amounts provided for in this Agreement, a management fee of up to \$450 per day per person Franchisor sends for the period of operation by Franchisor. Franchisor shall have the right to increase this daily rate effective on delivery of written notice to Franchisee. Franchisor shall have the right to cause itself to be paid and reimbursed any or all these amounts from revenues of the Food Service Counter(s), as well as all other amounts required to be paid under this Agreement.

14.13. Operation for Cause. If Franchisor determines that operation of the Food Service Counter(s) may be in jeopardy or if a default occurs, then in addition to all Franchisor's other rights and remedies, Franchisor shall have the right to operate the Food Service Counter(s) in the manner and on the terms provided in Section 14.12, for as long as Franchisor believes necessary or practical.

15. Default and Termination.

15.1. Immediate Termination Without Opportunity to Cure. Franchisee shall be deemed to be in default and Franchisor shall have the right to terminate this Agreement and/or any applicable addendum, without allowing Franchisee any opportunity to cure the default, effective immediately on delivery to Franchisee of written notice of termination, on the occurrence of any of the following events:

A. Franchisee is adjudicated bankrupt or insolvent or any substantial part of Franchisee's assets is assigned to or for the benefit of any creditor, or a petition in bankruptcy is filed by or against Franchisee and not immediately contested and dismissed within 60 days after filing, or a bill in equity or other proceeding for appointment of a receiver or other custodian of Franchisee or any assets of Franchisee is filed and consented to by Franchisee, or a court appoints a receiver or other temporary or permanent custodian of all or part of Franchisee's assets, or proceedings for a composition or arrangement with creditors under any federal or state law are instituted by or against Franchisee;

B. Franchisee is voluntarily or involuntarily dissolved;

C. Execution is levied against Franchisee or any real or personal property of Franchisee is sold after levy by a government body or official.

D. Franchisee stops operating or abandons the franchise by failing to operate at any Food Service Counter for three (3) consecutive days when Franchisee is required to operate, or any shorter period of time in which it is reasonable in the circumstances for Franchisor to conclude that Franchisee does not intend to continue to operate the Food Service Counter(s).

E. Any material complaint or subjective dissatisfaction expressed by the owner(s) or managers of the facility where any Food Service Counter operated by Franchisee is located, regardless of the reason for such complaint or subjective dissatisfaction; or the owner(s) or managers of the facility object for any reason to the continued operation of the Food Service Counter at the facility.

F. Franchisee (or, if Franchisee is an entity, any owner, member, partner, director, manager or officer of Franchisee) is convicted of or pleads no contest to a felony, fraud, crime involving moral turpitude, or other crime or offense which Franchisor reasonably believes is related to Franchisee's operation of the Food Service Counter(s) or is likely to have an adverse effect on the AFC System, the Marks or the goodwill associated with the Marks.

G. Franchisor determines that a threat or danger to public health or safety may result from Franchisee's continued operation of any Food Service Counter and/or Franchisee fails to cure any health and safety violation within 24 hours after notice of the violation.

H. Franchisee engages in any unlawful act, form of harassment or discrimination.

I. Franchisee (or, if Franchisee is an entity, any owner, member, partner, director, manager, or officer of Franchisee) purports to transfer any rights or obligations under this Agreement or any interest in Franchisee or any Food Service Counter operated by Franchisee, or any security interest, to any third party in violation of any terms or without satisfying any of the conditions within Sections 14.2 through 14.11.

J. There occurs any breach of any of the covenants in Sections 5.3, 6.1 through 6.4 or 14.2 through 14.11.

K. Franchisee makes any material misrepresentations relating to the acquisition of the franchise or engages in conduct which reflects materially and unfavorably on the operation and reputation of the franchise or franchise system.

L. Franchisor discovers that Franchisee knowingly or with reckless disregard maintained false books or records, or submitted a false report to Franchisor; intentionally concealed revenues; attempted to defraud Franchisor; misdirected or appropriated for Franchisee's own use any funds withheld from wages of employees; failed to properly withhold taxes, FICA, insurance or other benefits from employee wages; appropriated for Franchisee's own use any funds or other property of Franchisor; or knowingly permitted or, having discovered the facts, failed to take action against or discharge any employee who embezzled funds or other property of any customer of Franchisor, or anyone else.

M. Franchisee interferes or attempts to interfere with Franchisor's contractual relations with any third party, including but not limited to other franchisees, or interferes or attempts to interfere with Franchisor's ability or right to grant franchises or licenses to others to use the Marks or AFC System.

N. Franchisee repeatedly fails to comply with one or more provisions of this Agreement, whether or not cured after notice.

O. Franchisee fails to cure any default under this Agreement that materially impairs the goodwill associated with the Marks within 48 hours after delivery of written notice to cure;

P. Franchisee fails to satisfactorily complete initial training in Franchisor's sole judgment or to pass any required criminal background check and/or drug, tuberculosis or other chemical and disease testing;

Q. Any act of dishonesty or moral turpitude, either in Franchisee's operations, or in dealings with the facility owner where Franchisee's Food Service Counter(s) is/are located or in Franchisee's interactions with Franchisor.

15.2. Termination After Notice and Opportunity to Cure. Except as stated in Section 15.1, Franchisee shall have 15 calendar days after delivery by Franchisor of written notice to cure the breach or default under this Agreement and/or any applicable addendum, or if it cannot be cured in that time, to take within that time, and continue, all available steps to cure and to provide proof of those steps to Franchisor. Failure to cure in this time, or within this time to take and continue all available steps to cure, shall at Franchisor's election, result in termination of this Agreement and/or the applicable Franchise Addendum,

effective on expiration of the period allowed for cure as specified in the notice of default. However, if applicable law requires Franchisor to allow a larger period of time, then Franchisee shall have the period of time required by law to cure the breach or default.

15.3 Cross Default. Franchisee's breach of one agreement/addendum with Franchisor shall, at Franchisor's election also constitute a breach of every other agreement/addendum between Franchisee and Franchisor. A breach by franchisee of this Agreement shall also constitute, at Franchisor's election, a breach of all other agreements/addendums between Franchisee and Franchisor. Franchisor's election to enforce or not enforce this provision shall not constitute a waiver of any of Franchisor's rights or remedies against Franchisee hereunder.

15.4 Acts of Others. Franchisee shall be responsible for all acts and/or omissions of Franchisee's employees, managers, independent contractors and family members, regardless of whether Franchisee had actual notice of such actions/omissions.

15.5. Notice Required By Law. If any applicable law or regulation limits Franchisor's right to terminate this Agreement or requires greater notice or time to cure than stated in this Agreement, then Franchisor may allow additional time to conform to the minimum notice or cure period or restriction on termination required by that law or regulation. This Section 15.5 does not waive any right of Franchisor to challenge the validity or application of such law or regulation.

15.6. Effects of Termination or Expiration. On termination or expiration of this Agreement without renewal, Franchisee shall do all of the following:

A. Immediately pay all amounts due and owing to Franchisor and all sums due and owing to any third party relating to the operation of each of Franchisee's Food Service Counter(s);

B. Immediately stop using the Marks, and permanently refrain from doing business using any name or in any way that could tend to give the public the impression that Franchisee is or previously was operating a Food Service Counter associated with Franchisor; and refrain from using, in any manner, or for any purpose, any confidential information or trade secrets of Franchisor;

C. Immediately take all action needed to cancel any assumed name or equivalent registration pertaining to the Food Service Counter(s);

D. Revise all websites and social media pages controlled by Franchisee to remove references to the Food Service Counter(s) and Franchisor's Marks and System; and at Franchisor's request, assign to Franchisor all Internet domain names and social media accounts owned by Franchisee relating to the Food Service Counter(s).

E. Pay Franchisor all expenses incurred by Franchisor as a result of any breach or default by Franchisee, including, but not limited to, expenses Franchisor incurs on account of travel, lodging, meals, personnel compensation and operational costs;

F. At Franchisor's request, assign to Franchisor all of Franchisee's possessory interest in the Food Service Counter(s) operated by Franchisee; vacate the premises and provide all necessary assistance to enable Franchisor to take possession thereof;

G. Immediately return to or, as applicable, deliver to Franchisor the Manuals, all customer lists, all promotion material, all materials, signs and related items bearing the Marks; all forms and other materials or property of Franchisor, and any copies of these, in Franchisee's possession or control.

Franchisee shall also return to the facility owner, all property of the facility owner including, but not limited to, the facility owner's manuals, equipment, assets and any other items owned by the facility owner in Franchisee's possession;

H. Assign to Franchisor or its designee, all right, title and interest in and to the phone numbers of the Food Service Counter(s), notify the phone company and all listing agencies that Franchisee's right to use the phone numbers ended, and authorize the transfer of the phone numbers to Franchisor or its designee;

I. Cooperate with Franchisor in providing records of the Food Service Counter(s) and disclosing all other pertinent information;

J. Sign all documents which Franchisor may reasonably require to evidence and further accomplish termination of this Agreement and of Franchisee's rights to use the Marks and AFC System; and

K. Refrain from destroying, damaging, hiding or taking any equipment or inventory from the Food Service Counter(s) without Franchisor's written consent.

15.7 Option to Purchase. On termination or expiration of this Agreement, Franchisor shall have the option (but not the obligation), exercisable by delivering notice to Franchisee during the thirty (30) days following termination or expiration, to purchase the Assets of the Food Service Counter(s). For this Section 15.7, "Assets" means equipment, supplies, signage and non-perishable inventory.

A. The purchase price for the Assets will be the fair market value as reasonably determined by Franchisor. Any amounts Franchisee owes to Franchisor or its affiliates shall be applied to reduce the purchase price.

B. The balance of the purchase price, after the deductions in Section 15.7(A), shall be payable by Franchisor to Franchisee, at the closing. The closing shall occur at a date stated by Franchisor in the notice to Franchisee of Franchisor's exercise of the purchase option. That date shall be no later than 30 days after delivery of the notice, provided that the date may be later as reasonably determined by Franchisor to allow time for compliance with bulk sales laws. At closing, the parties shall execute and deliver all documents necessary to vest title in the purchased assets in Franchisor, free and clear of liens and encumbrances. Franchisee shall provide Franchisor with all information necessary to close the transaction.

C. Franchisor shall also have the right (but not the obligation) to purchase non-expired approved perishable inventory at Franchisee's Food Service Counter(s) at the time of expiration or termination of this Agreement. The purchase price for the non-expired approved perishable inventory will be the product cost paid by franchisee to acquire these products from Franchisor or Franchisor's approved suppliers. Any amounts Franchisee owes to Franchisor or its affiliates shall be applied to reduce the purchase price.

15.8 Continuing Effect. All provisions which by their terms or nature survive expiration or termination of this Agreement shall continue in effect regardless of expiration or termination until fully performed or until they expire by their nature.

16. Additional Provisions.

16.1. Compliance With Law. Franchisee shall operate the Food Service Counter(s) in compliance with all applicable laws, rules and regulations of all government authorities, including but not limited to federal and state laws pertaining to wages, hours, working conditions, unlawful discrimination, employment

verification, record keeping, workers compensation, leaves of absence, restrictions on employment of minors and other labor laws, social security and unemployment insurance contribution requirements, disability insurance, income tax and other withholdings, contributions, deposits and reporting as well as federal and state laws on operating a restaurant, health, safety and sanitation laws which also include health department inspections, menu and menu board labeling laws, food labeling laws, the Hazard Analysis and Critical Control Point (“HACCP”) food safety program adopted by the U.S. Food & Drug Administration and rules on handling, preparing and serving foods by people with communicable or infectious diseases.

16.2. Interpretation. Headings and section numbers in this Agreement are for convenience only and are not part of this Agreement. References to the owner or lessee of the premises where a Food Service Counter is located also include the applicable operator with whom Franchisor has arrangements that permit the establishment of the franchise granted by this Agreement. The provisions of this Agreement shall be interpreted according to their fair meanings and not strictly for or against any party.

16.3. Entire Agreement. This Agreement is the entire agreement of the parties. All prior written agreements, discussions, negotiations, representations and understandings of the parties are merged into and superseded by this Agreement. Nothing in this Agreement is intended to disclaim the representations made to Franchisee in the Franchise Disclosure Document.

16.4. Amendment. No modification of this Agreement will be valid unless executed in writing and signed by both parties. This provision shall not restrict updates and revisions to the Manuals.

16.5. Relationship of the Parties. The parties shall be independent contractors and not partners, joint venturers, principal-agent, employer-employee, or other relationship with each other. Franchisee shall have no authority or power to and shall not purport to obligate Franchisor to any person or entity. In all public records, letterhead and on signage at the Food Service Counter, Franchisee shall indicate its independent ownership of the franchised business and that the Food Service Counter is independently owned and operated. Franchisee shall not interfere with or disrupt Franchisor’s relationship with the owner(s) or lessee(s) of the premises where the Food Service Counter(s) is/are located, and shall not communicate with such owner(s) or lessee(s) concerning the relationship with Franchisor or any other matter not involving regular day to day operations of the Food Service Counter(s), without first obtaining Franchisor’s written consent. By way of example, and not limitation, Franchisee shall not communicate with the facility owner or its agents about pricing, menu changes, new concepts or other types of business opportunities involving the facility owner or otherwise. Franchisee shall never represent himself/ herself as an agent or employee of Advanced Fresh Concepts Franchise Corp. or Advanced Fresh Concepts Corp. Any complaint, petition and/or application that takes a position inconsistent with this Section, or other claim filed in violation of this Section shall be deemed a material breach of this Agreement.

16.6. No Waiver. Waiver of any breach or default on any occasion shall not constitute a waiver of any other or future breach or default.

16.7. Governing Law. This Agreement takes effect upon its acceptance and execution by Franchisor in California. This agreement shall be governed by and interpreted and construed according to the internal laws of California without regard for its principles of conflicts of law. However, (a) if a provision of this Agreement would not be enforceable under California law, and (b) if the Food Service Counter is located outside California; and (c) such provision would be enforceable under the laws of the state where the Food Service Counter is located; then such provision shall be interpreted and construed under the laws of the state where the Food Service Counter(s) is/are located. Where a California statute or rule of law provides that such statute or rule is inapplicable outside the state, for example, to a franchise located outside of California, or is inapplicable for another reason, such as an exemption, such law or rule shall not apply to Franchisee if located outside of California or if the circumstances of inapplicability apply. Nothing in this

Section 16.7 is intended to subject this Agreement to any franchise or similar law, rule, or regulation of any state to which it would not otherwise be subject.

16.8. Arbitration

A. Scope Of Arbitration: Any dispute that arises out of or relates directly or indirectly to this Agreement, including, without limitation, any claimed breach of this Agreement or any claim that any part of this Agreement (including this Section 16.8 or any part thereof) is invalid, illegal, unenforceable, voidable or void, or the relationship of the parties hereto shall be resolved by arbitration in accordance with the Commercial Arbitration Rules of the American Arbitration Association, as amended (the "Rules" - available upon request and at www.adr.org), except as provided for otherwise in paragraph I below. Sections 1281.4 and 1283.05 of the California Code of Civil Procedure are, by this reference, incorporated in and made a part of this Agreement and shall apply in connection with any arbitration under this Section 16.8. In the event the terms of this Agreement, (including Section 16.8), the Rules or any applicable arbitration statute differ or conflict with each other, the terms of this Agreement shall control over the Rules and the arbitration statute, and the Rules shall control over the arbitration statute. This arbitration provision shall be self-executing, and shall remain in effect after and regardless of expiration or termination of this Agreement.

B. Number Of Arbitrators: Should at any point the alleged damages exceed \$1,000,000 in total, exclusive of alleged interest, costs and/or attorney's fees, the dispute shall be heard and determined by a panel of three arbitrators. For all disputes, at least one arbitrator shall be a practicing attorney that specializes in franchise law.

C. Independent Arbitrations: The parties intend any dispute to be resolved as an independent arbitration, which is neither consolidated, classed, nor certified with any other claimant, arbitration or dispute. The parties waive all rights to resolving any dispute as consolidated, classed or certified with any other claimant, arbitration or dispute.

D. Location Of Arbitration: Arbitration shall occur in Los Angeles, California.

E. Discovery: After the appointment of the arbitrator(s), each side may commence discovery. Each side shall be limited to the following discovery: (a) no more than five (5) depositions of potential witnesses; (b) one set of written interrogatories; (c) one set of requests for production; and (d) one set of requests for admission. The aforementioned forms of written discovery shall not include more than 25 questions or requests within each set. The arbitrator(s) may permit requests for additional discovery for good cause. All objections are preserved for the arbitration hearing, except for objections based on privilege or proprietary/confidential information. All discovery shall be completed within eight months after the selection of the arbitrator(s), unless this period of time is shortened or extended by the arbitrator(s) for good cause or by stipulation of the parties.

F. Law And Motion: The arbitrator(s) shall set a briefing schedule, which sets a law and motion hearing date and the submission deadline for opposition and reply memoranda, no later than five days after the submission of any law and motion. The law and motion hearing date shall in no case be set more than 30 days after the original submission of any law and motion. Law and motion matters shall be decided, and a reasoned ruling issued as soon as practical, but in no case later than 15 business days after the scheduled law and motion hearing. Nothing in this subsection prevents any party from requesting ex parte relief as permitted by California law.

G. Pre-Award Costs of Arbitration: Administrative fees for operative arbitration demands shall be paid by the party filing the demand. Arbitrator fees/deposits and all costs for transcripts shall be allocated equally between each side. Unless accommodated otherwise by the alternative dispute

resolution center and/or the Rules, any party's failure to pay its portion of the fees and costs for the arbitration within the due dates set by the alternative dispute center shall result in the immediate suspension of the arbitration. In the event a suspension for non-payment of arbitration fees and costs continues for 30 days, the alternative dispute resolution center shall either enter the default of the non-paying party or the arbitration shall be dismissed. At the conclusion of the arbitration proceeding, the arbitrator(s) shall award the prevailing party the prevailing party's costs for the arbitration pursuant to Section 16.8(J).

H. Awards: All awards, including, without limitation, an interim or partial award, by the arbitrator(s) regarding the merits of the dispute shall be articulated in writing, signed by the arbitrator or a majority of the arbitrators (if applicable) and include a statement setting forth the reasons for the decision (a "reasoned award"). All awards shall be based on established law and shall not be made on broad principles of justice and equity. An award may be appealed to a court of competent jurisdiction for any errors of law, errors of legal reasoning or determination of fact that are clearly erroneous. Judgment on the final award may be entered in any court with competent jurisdiction. Except as otherwise provided in Section 16.8, an award may be entered against any party that fails to appear, defend, advance, attend, participate in, prosecute or obtain a postponement after being afforded due notice of the arbitration.

I. Injunctive/Provisional Remedies: Nothing in Section 16.8 or elsewhere in this Agreement limits a party's rights or remedies in connection with any action in any court of competent jurisdiction for injunctive or other provisional relief that a party deems necessary or appropriate to compel the other party to comply with the party's obligations under this Agreement, to protect the trade secrets or other intellectual property of a party against disclosure, or to prevent any threatened conduct that may cause loss or damage to a party under rules of equity, pending completion of arbitration. The parties agree that any failure to immediately cease operation, vacate the location of the operation or cease the use of intellectual property will cause irreparable injury and that money damages will not provide an adequate remedy. Both parties therefore consent to the issuance of an appropriate injunction.

J. Fees And Costs: The arbitrator(s) shall award to the prevailing party(ies) their fees and costs that were both incurred and relate directly to the claims allowing for an award of fees and costs. The arbitrator(s) shall consider the results of the entire arbitration and all claims filed, whether based in contract, statute or otherwise, in determining whether there is a prevailing party. The arbitrator(s) shall deny any motion/petition for fees that is not supported by a verified and detailed account of the time and expenses incurred. An award of fees and costs for all claims, including, without limitation, those based on a breach of this Agreement or for claims based on statute, may not exceed either: (a) in the event of a money award, one third the amount of compensatory damages awarded; or (b) in the event of a defense award, one third the greatest total amount claimed as damages at any point during the arbitration, including, without limitation, within any writing, testimony or argument. "Fees and costs" mean all reasonable expenses of the arbitration, including all administrative fees, arbitrator fees, travel expenses, out of pocket expenses, such as copying and telephone, court costs, legal research costs, discovery costs, expert witness fees, and attorney's fees. Except as otherwise provided above, a court of competent jurisdiction shall award fees and costs to the party that prevails on either a motion/petition for injunctive relief, as provided for in paragraph I above, or on a motion/petition to compel arbitration pursuant to this Section 16.8.

K. Severability Of Section 16.8: Should any part of Section 16.8 be ruled invalid, illegal, unenforceable, voidable or void, then the remainder of Section 16.8 shall still remain in effect. Should any part of Section 16.8 conflict with any non-waivable or non-modifiable statutory rights, Section 16.8 shall be interpreted and applied to the extent possible without conflicting with statutory rights.

16.9. Relief. Franchisee acknowledges that the breach or threatened breach of any provision within Sections 5.3, 6.1 through 6.4, 14.2 through 14.11 or 15.6 (B) through 15.6(K) would cause irreparable

harm to Franchisor for which there is no adequate remedy at law. Therefore Franchisor shall be entitled to preliminary and permanent injunctive relief to enjoin actual or threatened violation of any such provision.

16.10 Severability. If any provision of this Agreement is held to be invalid, the remaining provisions of this Agreement shall remain in effect. Should any provision of this Agreement be held to conflict with any statutory rights, such provision shall be interpreted and applied to the extent possible without conflicting with such statutory rights.

16.11. Notices. Except as otherwise stated in this Agreement, all notices which are required by this Agreement shall be deemed to be delivered 3 days after being placed in the U.S. Mail, certified mail, return receipt requested or priority mail with delivery receipt confirmation, or one day after being sent by United Parcel Service or other receipted overnight courier service if addressed to a party at the address stated in the introductory paragraph of this Agreement, or other address of which a party has given notice to the other, or immediately by hand delivery to a party. Franchisee shall provide Franchisor Franchisee’s physical address for notice purposes under this Section and shall keep Franchisor updated of any changes thereto.

16.12. Force Majeure. A party shall not be liable for delay in performance of up to 30 days, other than performance of an obligation to pay money to the other party, if the delay is due to terrorism, war, riot, strike or other labor trouble, utility failure, storm, fire, flood, earthquake, hurricane, explosion, embargo, blockade, insurrection, act of God or other similar event that is beyond the control of the parties. In the event of such delay, the time for performance will be extended by a period of time equal to the cause of the delay, but no longer than 30 days.

16.13. Opportunity to Review. Franchisee acknowledges having had an opportunity to review Franchisor’s Franchise Disclosure Document for at least 14 calendar days before signing any agreement with Franchisor or making any payment to Franchisor, to consult with an attorney and other professional advisors of Franchisee’s choice, and Franchisee has made the decision whether or not to consult with such advisors.

Executed as of the date first stated above:

FRANCHISEE

FRANCHISOR

ADVANCED FRESH CONCEPTS FRANCHISE CORP.

Signature _____

Signature _____

Printed Name _____

Printed Name _____

Title _____

Title _____

EXHIBIT A

GUARANTY

In exchange for Franchisor's execution of this Agreement, the undersigned unconditionally, absolutely and irrevocably guaranties and promises to pay and perform any and all indebtedness and obligations of Franchisee (an entity and/or operation in which the undersigned has an ownership interest) to Franchisor under this Agreement and all other Franchise Documents. If more than one person signs below, the obligations of the undersigned shall be joint and several.

Signature: _____

Print Name: _____

Signature: _____

Print Name: _____

Signature: _____

Print Name: _____

EXHIBIT B

UNION FOOD SERVICE COUNTER RIDER

Franchisee acknowledges and understands that Franchisee's Food Service Counter is covered by a union contract. As a result, employee rights, wages and benefits are regulated by the facility where the Food Service Counter and the applicable union is located. Franchisee acknowledges and agrees that because Franchisee's Food Service Counter is governed by a union contract, Franchisee shall comply with all union requirements, including, but not limited to, compensation for off the clock work.

Franchisee acknowledges and agrees to take any and all action needed to comply with the union contract then in effect.

FRANCHISEE

Signature _____

Printed Name _____

Title _____

EXHIBIT D

**FULL-TIME LOCATION FRANCHISE
ADDENDUM**

FULL-TIME LOCATION FRANCHISE ADDENDUM

This Full-Time Location Franchise Addendum (this "Addendum") is made this ____ day of _____, 20__ between Advanced Fresh Concepts Franchise Corp. ("Franchisor") and _____ ("Franchisee") with reference to the following facts:

RECITALS

Franchisor and Franchisee entered into a Franchise Agreement dated _____, 20__ (the "Franchise Agreement"). By this Addendum, Franchisee and Franchisor want to designate a location to be operated by Franchisee pursuant to Section 1 of the Franchise Agreement. Accordingly, the parties have agreed as follows:

A G R E E M E N T

The following provisions shall be deemed to be added to and made part of the Franchise Agreement:

A. **Grant.** Franchisor grants Franchisee the right to establish and operate a full-time Food Service Counter (the "Food Service Counter") using the AFC System and the Marks applicable to the selected _____ location, at the following _____ location:

_____ (the "Location").

B. **Food Service Counter Type.** (check or circle one):

- ____ Zenshi Counter
- ____ AFC Food Service Counter
- ____ Wild Blue Counter

C. **Initial Fee.** On signing this Addendum, Franchisee shall pay to Franchisor an initial fee of \$ _____ in lump sum. The fee shall be deemed to be fully earned on signing and is nonrefundable.

D. **Term.** The term of this Addendum starts immediately and shall expire or terminate at the same time as the Franchise Agreement. Franchisee shall start operating the Food Service Counter not later than _____, 20__, unless Franchisor consents in writing to extend the date.

E. **Initial Inventory.** Before Franchisee starts operation, Franchisor may elect to provide the Food Service Counter with equipment, initial supplies and inventory that Franchisor considers necessary to start operating, and Franchisee shall pay Franchisor's charges for these items.

F. **Payments to Franchisee.** Subject to Section 9.3 of the Franchise Agreement, Franchisor shall return to Franchisee ____ % of the Gross Sales of the Food Service Counter, as reported by and received from the owner of the facility where the Food Service Counter is located. Franchisor shall pay the amounts due to Franchisee, within 30 days after receiving the sales report and payment for the applicable period from the facility owner.

G. Operating Hours; Staffing. The Food Service Counter shall be operated on a full-time basis each day that the location where the Food Service Counter is located is open for business. The Food Service Counter shall have sufficient amount of food prepared and placed in the display case by 11:00 a.m. each day. The Food Service Counter shall be staffed during key trading hours. Franchisor shall have the right to revise these requirements on written notice to Franchisee. Franchisee shall ensure the Food Service Counter is adequately staffed and that the display case is adequately stocked during business hours.

H. Termination.

H.1. Franchisor may elect to terminate this Addendum for any grounds permitted in Section 15 of the Franchise Agreement. The parties mutually acknowledge that any termination of this Addendum shall not by itself be a termination of the Franchise Agreement or any other addendum between Franchisee and Franchisor. On termination of this Addendum, Franchisee shall comply with all the post termination provisions of Section 15.6 of the Franchise Agreement as applicable to the Food Service Counter.

H.2 Franchisor shall have the right to elect whether or not to terminate this Addendum either together with, or separate from the rest of the Franchise Agreement or any other addendum between Franchisee and Franchisor, according to the provisions of Sections 15.1 through 15.5 of the Franchise Agreement.

H.3. On termination or expiration of this Addendum, Franchisor shall have the option (but not the obligation), exercisable by delivering notice to Franchisee during the thirty (30) days following termination or expiration, to purchase the Assets of the Food Service Counter. "Assets" means equipment, supplies, signage and non-perishable inventory.

H.4. The purchase price for the Assets will be the fair market value as reasonably determined by Franchisor. Any amounts Franchisee owes to Franchisor or its affiliates shall be applied to reduce the purchase price.

H.5. The balance of the purchase price, after the deductions in Section H.4, shall be payable by Franchisor to Franchisee, at the closing. The closing shall occur at a date stated by Franchisor in the notice to Franchisee of Franchisor's exercise of the purchase option. That date shall be no later than 30 days after delivery of the notice, provided that the date may be later as reasonably determined by Franchisor to allow time for compliance with bulk sales laws. At closing, the parties shall execute and deliver all documents necessary to vest title in the purchased assets in Franchisor, free and clear of liens and encumbrances. Franchisee shall provide Franchisor with all information necessary to close the transaction.

H.6. Franchisor shall also have the right (but not the obligation) to purchase non-expired approved perishable inventory at the Food Service Counter at the time of expiration or termination of this Addendum. The purchase price for the non-expired approved perishable inventory will be the product cost paid by franchisee to acquire these products from Franchisor or Franchisor's approved suppliers. Any amounts Franchisee owes to Franchisor or its affiliates shall be applied to reduce the purchase price.

I. Miscellaneous.

I.1. Franchisee shall, with regard to the Food Service Counter, perform all the obligations, comply with all the restrictions, and be subject to all the provisions in the Franchise Agreement.

I.2. Defined terms not defined in this Addendum shall have the meaning provided in the Franchise Agreement.

I.3. This Addendum shall be deemed to be part of, and shall be subject to all other terms and conditions in, the Franchise Agreement.

I.4. In any conflict between the Franchise Agreement and this Addendum, the provisions in this Addendum shall control.

Signed as of the date first written above.

FRANCHISEE

Signature: _____

Print Name: _____

FRANCHISOR

ADVANCED FRESH CONCEPTS
FRANCHISE CORP.

By: _____

Print Name: _____

GUARANTY

In exchange for Franchisor's execution of this Agreement, the undersigned unconditionally, absolutely and irrevocably guaranties and promises to pay and perform any and all indebtedness and obligations of Franchisee (an entity and/or operation in which the undersigned has an ownership interest) to Franchisor under this Addendum and all other Franchise Documents. If more than one person signs below, the obligations of the undersigned shall be joint and several.

Signature: _____

Print Name: _____

Signature: _____

Print Name: _____

EXHIBIT E

PART-TIME LOCATION ADDENDUM

PART-TIME LOCATION FRANCHISE ADDENDUM

This Part-Time Location Franchise Addendum (this "Addendum") is made this ____ day of _____, 20__ between Advanced Fresh Concepts Franchise Corp. ("Franchisor") and _____ ("Franchisee") with reference to the following facts:

RECITALS

Franchisor and Franchisee entered into a Franchise Agreement dated _____, 20__ (the "Franchise Agreement"). By this Addendum, Franchisee and Franchisor want to designate a location to be operated by Franchisee pursuant to Section 1 of the Franchise Agreement. Accordingly, the parties have agreed as follows:

A G R E E M E N T

The following provisions shall be deemed to be added to and made part of the Franchise Agreement:

A. **Grant.** Franchisor grants Franchisee the right to establish and operate a part-time Food Service Counter (the "Food Service Counter") using the AFC System and the Marks applicable to the selected _____ location, _____ at _____ the following _____ location:

_____ (the "Location").

B. **Food Service Counter Type.** (check or circle one):

- _____ Zenshi Counter
- _____ AFC Food Service Counter
- _____ Wild Blue Counter

C. **Term.** The term of this Addendum starts immediately and shall expire or terminate at the same time as the Franchise Agreement. Franchisee shall start operating the Food Service Counter not later than _____, 20__, unless Franchisor consents in writing to extend the date.

D. **Initial Inventory.** Before Franchisee starts operation, Franchisor may elect to provide the Food Service Counter with equipment, initial supplies and inventory that Franchisor considers necessary to start operating, and Franchisee shall pay Franchisor's charges for these items.

E. **Payments to Franchisee.** Subject to Section 9.3 of the Franchise Agreement, Franchisor shall return to Franchisee ____ % of the Gross Sales of the Food Service Counter, as reported by and received from the owner of the facility where the Food Service Counter is located. Franchisor shall pay the amounts due to Franchisee, within 30 days after receiving the sales report and payment for the applicable period from the facility owner.

F. **Operating Hours; Staffing.** The Food Service Counter shall be operated on a part-time basis each day that the location where the Food Service Counter is located is open for business. The Food Service Counter shall have sufficient amount of food prepared and placed in the Food Service Counter's display case before trading hours each day. As a part-time location, the Food Service Counter shall not be required to have personnel physically present more than four hours per day. Franchisor shall have the right to revise

these requirements on written notice to Franchisee. Franchisee shall ensure the Food Service Counter is adequately staffed and that the display case is adequately stocked during business hours.

G. Termination.

G.1. Franchisor may elect to terminate this Addendum for any grounds permitted in Section 15 of the Franchise Agreement. The parties mutually acknowledge that any termination of this Addendum shall not by itself be a termination of the Franchise Agreement or any other addendum between Franchisee and Franchisor. On termination of this Addendum, Franchisee shall comply with all the post termination provisions of Section 15.6 of the Franchise Agreement as applicable to the Food Service Counter.

G.2 Franchisor shall have the right to elect whether or not to terminate this Addendum either together with, or separate from the rest of the Franchise Agreement or any other addendum between Franchisee and Franchisor, according to the provisions of Sections 15.1 through 15.5 of the Franchise Agreement.

G.3. On termination or expiration of this Addendum, Franchisor shall have the option (but not the obligation), exercisable by delivering notice to Franchisee during the thirty (30) days following termination or expiration, to purchase the Assets of the Food Service Counter. "Assets" means equipment, supplies, signage and non-perishable inventory.

G.4. The purchase price for the Assets will be the fair market value as reasonably determined by Franchisor. Any amounts Franchisee owes to Franchisor or its affiliates shall be applied to reduce the purchase price.

G.5. The balance of the purchase price, after the deductions in Section G.4, shall be payable by Franchisor to Franchisee, at the closing. The closing shall occur at a date stated by Franchisor in the notice to Franchisee of Franchisor's exercise of the purchase option. That date shall be no later than 30 days after delivery of the notice, provided that the date may be later as reasonably determined by Franchisor to allow time for compliance with bulk sales laws. At closing, the parties shall execute and deliver all documents necessary to vest title in the purchased assets in Franchisor, free and clear of liens and encumbrances. Franchisee shall provide Franchisor with all information necessary to close the transaction.

G.6. Franchisor shall also have the right (but not the obligation) to purchase non-expired approved perishable inventory at the Food Service Counter at the time of expiration or termination of this Addendum. The purchase price for the non-expired approved perishable inventory will be the product cost paid by franchisee to acquire these products from Franchisor or Franchisor's approved suppliers. Any amounts Franchisee owes to Franchisor or its affiliates shall be applied to reduce the purchase price.

H. Miscellaneous.

H.1. Franchisee shall, with regard to the Food Service Counter, perform all the obligations, comply with all the restrictions, and be subject to all the provisions in the Franchise Agreement.

H.2. Defined terms not defined in this Addendum shall have the meaning provided in the Franchise Agreement.

H.3. This Addendum shall be deemed to be part of, and shall be subject to all other terms and conditions in, the Franchise Agreement.

H.4. In any conflict between the Franchise Agreement and this Addendum, the provisions in this Addendum shall control.

Signed as of the date first written above.

FRANCHISEE

Signature: _____

Print Name: _____

FRANCHISOR

ADVANCED FRESH CONCEPTS
FRANCHISE CORP.

By: _____

Print Name: _____

GUARANTY

In exchange for Franchisor's execution of this Agreement, the undersigned unconditionally, absolutely and irrevocably guaranties and promises to pay and perform any and all indebtedness and obligations of Franchisee (an entity and/or operation in which the undersigned has an ownership interest) to Franchisor under this Addendum and all other Franchise Documents. If more than one person signs below, the obligations of the undersigned shall be joint and several.

Signature: _____

Print Name: _____

Signature: _____

Print Name: _____

Signature: _____

Print Name: _____

EXHIBIT F

SELF-SERVICE LOCATION ADDENDUM

SELF-SERVICE LOCATION ADDENDUM

This Self-Service Location Addendum (this “Addendum”) is made this ____ day of _____, 20__ between Advanced Fresh Concepts Franchise Corp. (“Franchisor”) and _____ (“Franchisee”) with reference to the following facts:

RECITALS

Franchisor and Franchisee entered into a Franchise Agreement dated _____, 20__ (the “Franchise Agreement”). Franchisee wants to establish a self-service food service counter, to be operated pursuant to the Franchise Agreement. Franchisor is willing to let Franchisee do so on the terms in this Addendum. Accordingly, the parties have agreed as follows:

A G R E E M E N T

The following provisions shall be deemed to be added to and made part of the Franchise Agreement:

A. **Grant.** Franchisor grants Franchisee the right to establish and operate a self-service food service counter (the “Self-Service Food Service Counter”) using the AFC System and the Marks applicable to the selected location, at the following location _____ (the “Self-Service Location”).

B. **Self-Service Food Service Counter Type.** (check or circle one):

____ Zenshi Counter

____ AFC Food Service Counter

____ Wild Blue Counter

C. **Term.** The term of this Addendum starts immediately and shall expire or terminate at the same time as the Franchise Agreement. Franchisee shall start operating the Self-Service Food Service Counter not later than _____, 20__ , unless Franchisor consents in writing to extend the date.

D. **Initial Inventory.** Before Franchisee starts operation, Franchisor may elect to provide the Self-Service Food Service Counter with equipment, initial supplies and inventory that Franchisor considers necessary to start operating, and Franchisee shall pay Franchisor’s charges for these items.

E. **Payments to Franchisee.** Subject to Section 9.3 of the Franchise Agreement, Franchisor shall return to Franchisee ____ % of the Gross Sales of the Self-Service Food Service Counter, as reported by and received from the owner of the facility where the Self-Service Food Service Counter is located. Franchisor shall pay the amounts due to Franchisee, within 30 days after receiving the sales report and payment for the applicable period from the facility owner.

F. **Operation.**

F.1. Franchisee shall have the right to operate at the Self-Service Location, but only a Self-Service Food Service Counter operating pursuant to the Franchise Agreement, as amended by this Addendum.

F.2. Franchisee shall perform all food preparation for the Self-Service Food Service Counter only at the following facility: _____
_____ and shall deliver the products to and place them for display at the Self-Service Food Service Counter.

F.3. Franchisee or Franchisee's personnel shall inspect the Self-Service Food Service Counter at least once daily and cause a sufficient amount of sushi and other food products to be placed in the display case before trading hours each day. Franchisor shall have the right to revise these requirements on written notice to Franchisee. The Self-Service Food Service Counter shall be adequately stocked during business hours.

G. Termination.

G.1. Franchisor may elect to terminate this Addendum at any time and for any reason or no reason on 30 day written notice. The parties mutually acknowledge that any termination of this Addendum shall not by itself be termination of the Franchise Agreement. On termination of this Addendum, Franchisee shall comply with all the post termination provisions of Section 15.6 of the Franchise Agreement as applicable to the Self-Service Food Service Counter.

G.2. Franchisor shall have the right to elect whether or not to terminate this Addendum either together with, or separate from the rest of the Franchise Agreement or any other addendum between Franchisee and Franchisor, according to the provisions of Sections 15.1 through 15.5 of the Franchise Agreement.

G.3. On termination or expiration of this Addendum, Franchisor shall have the option (but not the obligation), exercisable by delivering notice to Franchisee during the thirty (30) days following termination or expiration, to purchase the Assets of the Self-Service Food Service Counter. "Assets" means equipment, supplies, signage and non-perishable inventory.

G.4. The purchase price for the Assets will be the fair market value as reasonably determined by Franchisor. Any amounts Franchisee owes to Franchisor or its affiliates shall be applied to reduce the purchase price.

G.5. The balance of the purchase price, after the deductions in Section G.4, shall be payable by Franchisor to Franchisee, at the closing. The closing shall occur at a date stated by Franchisor in the notice to Franchisee of Franchisor's exercise of the purchase option. That date shall be no later than 30 days after delivery of the notice, provided that the date may be later as reasonably determined by Franchisor to allow time for compliance with bulk sales laws. At closing, the parties shall execute and deliver all documents necessary to vest title in the purchased assets in Franchisor, free and clear of liens and encumbrances. Franchisee shall provide Franchisor with all information necessary to close the transaction.

G.6. Franchisor shall also have the right (but not the obligation) to purchase non-expired approved perishable inventory at the Self-Service Food Service Counter at the time of expiration or termination of this Addendum. The purchase price for the non-expired approved perishable inventory will be the product cost paid by franchisee to acquire these products from Franchisor or Franchisor's approved suppliers. Any amounts Franchisee owes to Franchisor or its affiliates shall be applied to reduce the purchase price.

H. Miscellaneous.

H.1. Franchisee shall, with regard to the Self-Service Food Service Counter, perform all the obligations, comply with all the restrictions, and be subject to all the provisions in the Franchise Agreement.

H.2. Defined terms not defined in this Addendum shall have the meaning provided in the Franchise Agreement.

H.3. This Addendum shall be deemed to be part of, and shall be subject to all other terms and conditions in, the Franchise Agreement.

H.4. In any conflict between the Franchise Agreement and this Addendum, the provisions in this Addendum shall control.

Signed as of the date first written above.

FRANCHISEE

FRANCHISOR

ADVANCED FRESH CONCEPTS
FRANCHISE CORP.

Signature: _____

By: _____

Print Name: _____

Print Name: _____

Title: _____

Title: _____

GUARANTY

In exchange for Franchisor's execution of this Agreement, the undersigned unconditionally, absolutely and irrevocably guaranties and promises to pay and perform any and all indebtedness and obligations of Franchisee (an entity and/or operation in which the undersigned has an ownership interest) to Franchisor under this Addendum and all other Franchise Documents. If more than one person signs below, the obligations of the undersigned shall be joint and several.

Signature: _____

Print Name: _____

Signature: _____

Print Name: _____

Signature: _____

Print Name: _____

EXHIBIT G

GENERAL RELEASE

**ADVANCED FRESH CONCEPTS FRANCHISE CORP.
GENERAL RELEASE AGREEMENT**

THIS GENERAL RELEASE AGREEMENT (this “**Release Agreement**”) is made and entered into as of _____ (the “**Effective Date**”), by and among **ADVANCED FRESH CONCEPTS FRANCHISE CORP.**, a California corporation (“**Franchisor**”), on the one hand, and _____ a _____ (“**Franchisee**”), and _____ (“**Owner**”), on the other hand, who are collectively referred to in this Release Agreement as the “**Releasing Parties**”, with reference to the following facts:

A. Franchisor and Franchisee are parties to that certain Franchise Agreement and related ancillary agreements dated _____ (collectively, the “**Franchise Agreement**”) pursuant to which Franchisor granted Franchisee a license (the “**License**”) to use the service marks and trade names “**Zenshi**,” “**AFC**,” “**Wild Blue**,” “**Hybrid Sushi**,” “**Southern Tsunami**,” and other related trademarks, service marks, logos and commercial symbols (the “**AFC Marks**”) and the “**AFC System**” (the “**System**”) in connection with the operation of one or more AFC Food Service Counter(s)/Wild Blue Counter(s) (collectively, the “**Food Service Counter(s)**”) located at _____ (the “**Franchised Location**”).

B. Franchisee desires to enter into a _____.

C. This Release Agreement has been requested at a juncture in the relationship of the parties where Franchisor is considering either a change or an expansion of the relationship between the parties and/or their affiliates. Franchisor is unwilling to make the anticipated change or expansion in the relationship of the parties unless it is certain that it is proceeding with a “clean slate” and that there are no outstanding grievances or Claims against it. Releasing Parties are willing to enter into this Release Agreement in consideration for receiving the agreement of Franchisor to an anticipated change or expansion of the relationship between the parties. Releasing Parties acknowledge that this Release Agreement is intended to wipe the slate clean.

NOW, THEREFORE, IT IS AGREED:

1. **DEFINITIONS.** As used in this Release Agreement, the following capitalized terms have the meanings ascribed to them.

1.1 “**Claims**” means all actual and alleged claims, demands, Losses, charges, agreements (whether written or oral), covenants, responsibilities, warranties, obligations, contracts (whether oral or written), debts, violations, suits, counterclaims, cross claims, third party claims, accounts, liabilities, costs, expenses (including attorneys’ fees and court costs), rights to terminate and rescind, rights of action and causes of action of any kind or nature, whatsoever, whether known or unknown, matured or unmatured, accrued or unaccrued, suspected or unsuspected, contingent or non-contingent, liquidated or unliquidated, choate or inchoate, and whether or not asserted, threatened, alleged, or litigated, at law, equity, or otherwise.

1.2 “**Constituents**” means past, present and future affiliates, subsidiaries, parent companies, divisions, partners, members, trustees, receivers, executors, representatives, administrators, owners, shareholders, distributors, predecessors, officers, directors, agents, managers, principals, employees, insurers, successors, assigns, representatives and attorneys and the past, present and future officers, directors, agents, managers, principals, members, employees, insurers, successors, assigns, representatives and attorneys of each of the foregoing.

1.3 “**Excluded Matters**” means Franchisor’s continuing contractual obligations which arise or continue under and pursuant to the Franchise Agreement on and after the date of this Release Agreement.

1.4 “**Franchisor Released Parties**” means Franchisor, Advanced Fresh Concepts Franchise Corp., a California corporation, and each of its Constituents.

1.5 “**Losses**” means all damages, debts, liabilities, accounts, suits, awards, judgments, payments, diminutions in value and other losses, costs and expenses, however suffered or characterized, all interest thereon, all costs and expenses of investigating any Claim, reference proceeding, lawsuit or arbitration and any appeal therefrom, all actual attorneys’ fees incurred in connection therewith, whether or not such Claim, reference proceeding, lawsuit or arbitration is ultimately defeated and, all amounts paid incident to any compromise or settlement of any such Claim, reference proceeding, lawsuit or arbitration.

2. **GENERAL RELEASE AGREEMENT**. Releasing Parties, for themselves and their Constituents, hereby release and forever discharge Franchisor Released Parties from any and all Claims, whether known or unknown, based upon anything that has occurred or existed, or failed to occur or exist, from the beginning of time to the Effective Date, including, without limitation any and all Claims which relate to the Franchise Agreement, any addendum thereto, the Food Service Counter(s), the System, the License, the Marks, and the Franchised Location, and any other agreement entered into prior to the Effective Date between Franchisor Released Parties, on the one hand, and Releasing Parties, on the other hand, except for the Excluded Matters and obligations under this Release Agreement. This waiver, release and discharge is effective immediately in its fullest and most comprehensive sense. This Release Agreement does not apply with respect to claims arising under the Washington Franchise Investment Protection Act, RCW 19.100, and the rules adopted thereunder.

3. **WAIVER OF SECTION 1542 OF THE CALIFORNIA CIVIL CODE**.

3.1 **Section 1542 of the California Civil Code**. Releasing Parties, for themselves and their Constituents, acknowledge that they are familiar with Section 1542 of the California Civil Code, which reads as follows:

A GENERAL RELEASE DOES NOT EXTEND TO CLAIMS THAT THE CREDITOR OR RELEASING PARTY DOES NOT KNOW OR SUSPECT TO EXIST IN HIS OR HER FAVOR AT THE TIME OF EXECUTING THE RELEASE, AND THAT IF KNOWN BY HIM OR HER WOULD HAVE MATERIALLY AFFECTED HIS OR HER SETTLEMENT WITH THE DEBTOR OR RELEASING PARTY.

3.2 **Waiver**. With respect to those Claims being released pursuant to Section 2, Releasing Parties, for themselves and their Constituents, acknowledge that they are releasing unknown Claims and waive all rights they have or may have under Section 1542 of the California Civil Code or any other statute or common law principle of similar effect. For purposes of this Section 3, Releasing Parties shall be considered to be creditors of the Franchisor Released Parties, and each of them.

4. **UNKNOWN CLAIMS**. Releasing Parties acknowledge and agree that among the wide and comprehensive range of Claims being waived, released, and discharged by this Release Agreement, they are waiving, releasing, and discharging unknown and unsuspected Claims which, if known or suspected by Releasing Parties to exist in their favor at the time of executing this Release Agreement, may have materially affected Releasing Parties’ decision to enter into this Release Agreement. It is understood by Releasing Parties that, after the Effective Date, the facts under which this Release Agreement is entered into may turn out to be other than or different from the facts Releasing Parties knew or believed to be true on the Effective Date. Releasing Parties, therefore, expressly assume the risk of the facts turning out to be so different and agree that

this Release Agreement shall be in all respects final and effective and not subject to termination or rescission by any such difference in facts.

5. **REPRESENTATIONS AND WARRANTIES.** Releasing Parties hereby represent and warrant that, in entering into this Release Agreement, Releasing Parties: (i) are doing so freely and voluntarily, either upon the advice of counsel and business advisors of Releasing Parties' own choosing, or without such advice because Releasing Parties, free from coercion, duress or fraud, declined to obtain such advice; (ii) have read and fully understand the terms and scope of this Release Agreement; (iii) understand that this Release Agreement is final and conclusive, and intends to be final and conclusive, as to the matters set forth in this Release Agreement; and (iv) have not assigned, transferred, or conveyed to any third party all or any part of their interest, or any contingent interest, in any of the Claims released by this Release Agreement now or in the future, and are aware of no third party who contends or claims otherwise, and shall not purport to assign, transfer, or convey any interest in any such Claim after the Effective Date.

6. **COVENANTS NOT TO SUE.** Releasing Parties hereby irrevocably covenant that they will not, directly or indirectly: (i) commence, initiate, or cause to be commenced or initiated any proceeding, claim, or demand of any kind against Franchisor Released Parties based upon any Claims released under this Release Agreement; or (ii) assist or encourage any person or entity to investigate, inquire into, commence, initiate, or cause to be commenced or initiated any proceeding, claim, or demand of any kind against Franchisor Released Parties based upon any Claims released under this Release Agreement.

7. **INDEMNITY.** Without in any way limiting any of the rights and remedies otherwise available to the Franchisor Released Parties, Releasing Parties shall defend, indemnify and hold harmless each Franchisor Released Party from and against all Claims whether or not involving third-party Claims, arising directly or indirectly from or in connection with: (i) the assertion by or on behalf of Releasing Parties or their Constituents of any Claim or other matter released pursuant to this Release Agreement; (ii) the assertion by any third party of any Claim or demand against any Franchisor Released Party which Claim or demand arises directly or indirectly from, or in connection with, any Claim or other matter released pursuant to this Release Agreement; (iii) any breach of representations, warranties or covenants hereunder by Releasing Parties or its Constituents; or (iv) the Franchise Agreement, the Food Service Counter(s), the Franchised Location, and/or any and all claims of creditors, customers, vendors, suppliers or invitees of the Food Service Counter(s), or other third parties, for obligations incurred and/or acts or omissions to act by Franchisee, both prior to and following the Effective Date.

8. **GENERAL PROVISIONS.**

8.1 **Amendment.** This Release Agreement cannot be modified, altered or otherwise amended except by an agreement in writing signed by all of the parties.

8.2 **Entire Agreement.** This Release Agreement, together with the agreements referenced in this Release Agreement, constitute the entire understanding between and among the parties with respect to the subject matter of this Release Agreement and supersedes any prior negotiations, understandings, representations, and agreements with respect to the subject matter of this Release Agreement. Nothing in this Release Agreement is intended to disclaim the representations made to Franchisee in the Franchise Disclosure Document. The Recitals set forth in Paragraphs A through C of this Release Agreement are true and correct and are incorporated into this Release Agreement as part of this Release Agreement.

8.3 **Counterparts and Electronic Transmission; Electronic Signatures.** This Release Agreement may be executed in any number of counterparts, each of which shall be deemed to be an original and all of which together shall be deemed to be one and the same instrument. Copies of this Release Agreement with signatures that have been transmitted by email or by facsimile shall constitute and be deemed original

copies of this Release Agreement for all purposes, provided that the copies are fully executed, dated and identical in form to the original hard copy version of this Release Agreement. In addition, this Release Agreement may be signed electronically by the parties and electronic signatures appearing on this Release Agreement shall be deemed to be the same as handwritten signatures for the purposes of the validity, enforceability and admissibility of this Release Agreement.

8.4 **Heirs, Successors and Assigns.** This Release Agreement shall be binding upon and inure to the benefit of the parties and their respective heirs, successors and permitted assigns. In addition, each of Franchisor Released Parties that is not a party shall be a third party beneficiary of this Release Agreement, with the right to enforce this Release Agreement for his, her, or its benefit, whether acting alone or in combination with any other Franchisor Released Party.

8.5 **Interpretation.** The rule that an agreement is to be construed against the party drafting the agreement is hereby waived by the parties, and shall have no applicability in construing this Release Agreement or any of its terms. The headings used in this Release Agreement are for purposes of convenience only and shall not be used in construing the provisions of this Release Agreement. As used in this Release Agreement, the male gender shall include the female and neuter genders, the singular shall include the plural and the plural, the singular.

8.6 **Severability and Validity.** Any provision of this Release Agreement which is prohibited, unenforceable or not authorized in any jurisdiction shall, as to such jurisdiction, be ineffective to the extent of such prohibition, unenforceability or non-authorization without invalidating the remaining provisions of this Release Agreement or affecting the validity, enforceability or legality of such provision in any other jurisdiction.

8.7 **Governing Law and Venue.** This Release Agreement shall be interpreted and construed under the laws of California. In the event of any conflict of law, the law of California shall prevail, without regard to the application of California conflict of law rules. If, however, any provision of this Release Agreement would not be enforceable under the laws of California, and if the Food Service Counter(s) is/are located outside of California and such provision would be enforceable under the laws of the state in which the Food Service Counter(s) is/are located, then such provision shall be interpreted and construed under the laws of that state. Nothing in this Section 8.7 is intended by the parties to subject this Release Agreement to any franchise or similar law, rules, or regulation of the state of California to which it would not otherwise be subject.

8.8 **Arbitration.** Except as precluded by applicable law, any controversy or claim that arises out of or relates to this Release Agreement, or any breach of this Release Agreement, including without limitation any claim that any of this Release Agreement (including this Paragraph 8.8) is invalid, illegal, voidable or void, shall be submitted to arbitration in accordance with the rules of the American Arbitration Association and judgment on the award may be entered in any court with jurisdiction thereof. Unless applicable law requires otherwise, arbitration shall occur in Los Angeles, California. This arbitration provision shall be self-executing, and shall remain in effect after and regardless of expiration or termination of this Release Agreement. If a party fails to appear at any properly noticed arbitration proceeding, an award may be entered against such party regardless of such failure to appear. The prevailing party in any arbitration or other proceeding shall be entitled to recover its reasonable attorneys' fees and costs.

8.9 **Authority of Franchisor.** Franchisor represents and warrants that (i) Franchisor has the power and authority to enter into this Release Agreement and to perform its obligations under this Release Agreement without the approval or consent of any other person or entity, and (ii) the individual who executes this Release Agreement on Franchisor's behalf is duly authorized to do so without the approval or consent of any other person or entity.

8.10 **Authority of Releasing Parties.** Releasing Parties represent and warrant that (i) they have the power and authority to enter into this Release Agreement and to perform their obligations under this Release Agreement without the approval or consent of any other person or entity, and (ii) the individuals who execute this Release Agreement on Releasing Parties' behalfs are duly authorized to do so without the approval or consent of any other person or entity.

8.11 **No Waiver.** No delay, waiver, omission, or forbearance on the part of any party to exercise any right, option, duty, or power arising out of any breach or default by any other party of any of the terms, provisions, or covenants of this Release Agreement, and no custom or practice by the parties at variance with the terms of this Release Agreement, shall constitute a waiver by any party to enforce any such right, option, or power as against the other parties, or as to a subsequent breach or default by the other parties.

8.12 **Attorneys' Fees.** If any legal action is brought to enforce the terms of this Release Agreement, the prevailing party shall be entitled to reasonable attorneys' fees and costs, and any and all costs of collection, in addition to any other relief to which that party may be entitled.

8.13 **Further Acts.** The parties agree to execute, acknowledge and deliver to any requesting party, and to procure the execution, acknowledgment and delivery to any requesting party, of any additional documents or instruments which the requesting party may reasonably require to fully effectuate and carry out the provisions of this Release Agreement.

IN WITNESS WHEREOF, the parties to this Release Agreement have executed this Release Agreement as of the Effective Date.

FRANCHISOR:

ADVANCED FRESH CONCEPTS FRANCHISE
CORP., A California corporation

By: _____
Name: _____
Title: _____

FRANCHISEE:

A _____

By: _____
Name: _____
Title: _____

OWNER:

_____, an individual

_____, an individual

EXHIBIT H

ASSIGNMENT OF FRANCHISE AGREEMENT AND FRANCHISOR CONSENT

Assignment of Franchise Agreement and Franchisor Consent

This Assignment of Franchise Agreement (this “Assignment”) is executed on **DATE** by and between **FRANCHISEE NAME** an individual (“Franchisee”), and **COMPANY NAME** a **STATE** corporation (“Assignee Entity”).

Recitals

On **FRANCHISE AGREEMENT DATE** Franchisee entered into a franchise agreement (the “Franchise Agreement”) with Advanced Fresh Concepts Franchise Corp. (“Franchisor”) for the operation of a sushi bar or food service counter at the following location: **STORE NAME AND LOCATION** (the “Food Service Counter”).

Franchisee owns a majority of the outstanding stock or membership interests of Assignee Entity. Franchisee desires to assign his or her Franchise Agreement to the Assignee Entity according to the terms of this Assignment. Accordingly:

Assignment

For Value Received, Franchisee sells, assigns and transfers to Assignee Entity all right, title and interest in and to the Franchise Agreement between Franchisee and Franchisor, concerning the Food Service Counter.

Franchisee Signature: _____

Printed Name: _____

This Assignment is Accepted. Assignee Entity agrees to abide by all terms, conditions and obligations of Franchisee under the Franchise Agreement.

COMPANY NAME
[Assignee Entity Name]

EIN #
[EIN Number]

Signature: _____

Printed Name: _____

Title: _____

Franchisor Consent

By signing below, Advanced Fresh Concepts Franchise Corp., a California corporation, consents to the foregoing assignment, effective on _____.

ADVANCED FRESH CONCEPTS FRANCHISE CORP.
a California corporation

Signature _____

Printed Name _____

Title _____

Guaranty

In exchange for Franchisor's execution of this Agreement, Franchisee absolutely and irrevocably guaranties and promises to pay and perform any and all indebtedness and obligations of Assignee Entity (an entity and/or operation in which the undersigned has an ownership interest) to Franchisor under the Franchise Agreement and all other franchise documents between Assignee Entity and Franchisor.

Signature: _____

Print Name: _____

Date: _____

EXHIBIT I

**ASSET SALE AND PURCHASE
AGREEMENT**

Notice to Buyer and Seller
This is a streamlined, basic form of Agreement
It may not cover all circumstances of your transaction.
You can edit, add to or delete from this Agreement to fit your transaction.

PLEASE REMOVE THIS SENTENCE AND ABOVE PARAGRAPH BEFORE SIGNING

ASSET SALE AND PURCHASE AGREEMENT

This ASSET SALE AND PURCHASE AGREEMENT is entered into this ____ day of _____, 20__, by and between _____ (“Buyer”), and Advanced Fresh Concepts Corp, a California corporation, its Designee or Affiliate (“Seller”).

RECITALS

Seller owns assets of a Zenshi Counter/AFC Food Service Counter/Wild Blue Counter (the “**Food Service Counter**”) located at _____ (the “Location”). These include the assets listed on Exhibit A to this Agreement. Seller desires to sell, assign and transfer to Buyer, and Buyer desires to purchase and acquire from Seller, the assets listed on Exhibit A to this Agreement. Accordingly, the parties have agreed as follows:

AGREEMENT

1. **Purchase and Sale**

1.1 **Purchase and Sale.** Seller agrees to sell, transfer, assign and convey to Buyer, and Buyer agrees to purchase and acquire from Seller, on the Closing Date (as hereinafter defined), all the assets listed in Exhibit A attached to this Agreement and incorporated here by this reference (the “Assets”).

1.2 **Purchase Price.** The total purchase price for the Assets will be of the sum of \$ _____, together with the assumption by Buyer of the following liabilities and obligations _____.

1.3 **Payment.** The purchase price stated in Section 1.2 shall be payable in cash or cashier’s check on the Closing Date.

1.4 **Allocation of Purchase Price.** The allocation of the purchase price among the Assets for purposes of federal and state income and franchise tax shall be as follows:
\$ _____ to Equipment; \$ _____ to Food Products; \$ _____ to Value of Established Market; and \$ _____ Other.

1.5 **Further Assurances.** From time to time at a party’s request, whether at or after the Closing Date, the other party shall execute and deliver such instruments and documents and take such other action as the requesting party reasonably requests to more completely convey and transfer the Assets intended to be transferred hereunder.

1.6 **Limitation.** Buyer shall have no obligation to assume any obligation of Seller, whether under any contract, lease or other instrument, or arising by law or otherwise, other than as expressly stated in this Agreement.

2. Closing

2.1 Closing Date. The closing will take place at the offices of _____, on _____, 20__ at _____m., or at such other time and place as may be agreed by Seller and Buyer, provided, however at Seller's sole discretion, that this Agreement shall terminate and be of no force and effect if the closing Date shall not have occurred prior to _____, 20__; and provided, further, that such termination shall not affect the rights or remedies of either party under this Agreement with respect to a breach of, or default under, this Agreement by the other party. On consummation, the closing shall be deemed to take place as of the close of business on the closing date. The time and date of the closing are herein referred to as the "Closing Date."

2.2 Deliveries. At the closing, Seller will deliver to Buyer, against receipt of the purchase price referred to in Section 1.2, a bill of sale and other instruments of transfer and conveyance as reasonably requested by Buyer. At the closing, Buyer will deliver to Seller such instruments of assumption as reasonably requested by Seller.

3. Seller's Representations and Warranties.

Seller represents and warrants to Buyer as follows:

3.1 Organization and Good Standing. Seller is duly organized, validly existing and in good standing under the laws of the State of California and has all requisite power and authority to own, operate and lease its properties and to carry on its business as now being conducted.

3.2 Ownership. Seller owns all right, title and interest in and to the Assets, free and clear of liens and encumbrances other than as provided herein, and has the full right and power to transfer and assign the Assets to Buyer pursuant to this Agreement.

3.3 Authorization. Seller has full power and authority to sign, deliver and perform this Agreement and sell the Assets to Buyer. The signing, delivery and performance by Seller of this Agreement and the transactions contemplated by this Agreement have been duly authorized by all necessary and proper corporate action. This Agreement is a legal, valid and binding obligation of Seller, and each instrument contemplated by this Agreement when executed and delivered by Seller in accordance with the provisions hereof, will be a legal, valid and binding obligation of Seller, in each case enforceable against Seller in accordance with its terms.

4. Buyer's Representations and Warranties.

Buyer represents and warrants to Seller as follows:

4.1 Organization and Good Standing. If Buyer is identified in this Agreement as a corporation or limited liability company or other form of entity, Buyer is duly organized, validly existing and in good standing under the laws of the State of _____, has all requisite power and authority to own, operate and lease its properties and to carry on its business as now being conducted.

4.2 Authorization. Buyer has full power and authority to sign, deliver and perform this Agreement and buy the Assets from Seller. The signing, delivery and performance by Buyer of this Agreement and the transactions contemplated by this Agreement have been, duly authorized by all necessary and proper corporate action. This Agreement is a legal, valid and binding obligation of Buyer and each instrument contemplated by this Agreement when signed and delivered by Buyer in accordance with the

provisions hereof, will be a legal, valid and binding obligation of Buyer, in each case enforceable against Buyer in accordance with its terms.

4.3 No Breach or Violation. Neither the signing nor delivery of this Agreement nor the consummation of the transactions contemplated hereby will conflict with or result in a violation or breach of, or constitute a default under, any mortgage, lease or agreement, pursuant to which Buyer is a party or violate any judgment, order, permit, or decree binding on Buyer.

4.4 Documents and Records. Any documents and records being delivered to Seller are true, complete and correct.

5. Covenants.

5.1 Sales Tax. Buyer shall be responsible for the payment to the _____ of any sales tax which may become due by virtue of the sale of the Assets contemplated by this Agreement.

5.2 Bulk Transfer Laws. [] [] [Both parties initial if applicable or delete if not applicable. If neither initialed nor deleted, this provision shall apply.] The parties mutually agree to waive compliance with the bulk sales provisions of the Uniform Commercial Code of the State of _____, or any other applicable “bulk transfer” law in connection with the sale of the Assets, and Seller agrees to indemnify Buyer against all claims, losses, expenses, obligations, damages or liabilities occurring or arising from such waiver of compliance. Nothing herein contained shall be construed as an acknowledgment by any person that any such law is applicable to such sale.

5.3 Obligations to Personnel. Seller shall be solely responsible for payment of and shall pay all compensation and benefits due or to become due to personnel of the Food Service Counter operated at the Location for services performed through the Closing Date.

6. Conditions to Buyer’s Obligations. Buyer’s obligations to consummate the transactions contemplated by this Agreement are subject to the performance or satisfaction of the following condition on the Closing Date:

6.1 Bulk Transfer Law. If Section 5.2 has been deleted then Buyer and Seller shall have taken all such action as may be required to comply with all provisions of the Uniform Commercial Code - Bulk Transfer Law applicable to the transactions contemplated by this Agreement.

7. Conditions to Seller’s Obligations. Seller’s obligation to consummate the transactions contemplated by this Agreement are subject to the performance or satisfaction of the following conditions on or before the Closing Date:

7.1 Representations and Warranties. Buyer’s representations and warranties in this Agreement or in any certificate, document or instrument delivered pursuant hereto or in connection with the transactions contemplated hereby shall be true and correct in all material respects as of the Closing Date as if made on and as of the Closing Date.

7.2 Covenants. Buyer shall have performed and complied with all the covenants, agreements and conditions required by this Agreement to be performed or complied with by Buyer, on or before the Closing Date.

7.3 Officers’ Certificate. Seller shall have been furnished with a certificate executed on behalf of Buyer by its President or a Vice President, and its Secretary or Assistant Secretary, and by each other

person constituting the Buyer, dated the Closing Date, representing and certifying in such detail as Seller may reasonably request, as to the satisfaction of the conditions set forth in Sections 7.1 and 7.2.

7.4 No Actions or Proceedings. There will not be pending or threatened any action or proceeding before any court of governmental body or agency which would seek to restrain, prohibit or invalidate any transaction contemplated by this Agreement.

8. Survival and Indemnification.

8.1 Survival. The representations and warranties of Seller and Buyer in this Agreement and any provision of this Agreement intended, by its terms, to be observed and performed after the closing, shall survive the execution of this Agreement and the Closing Date.

8.2 Buyer's Indemnification. Buyer shall indemnify and hold Seller harmless from and against any damages, losses, liabilities, claims or expenses (including court costs and reasonable attorneys' fees) (the "Damages") arising from the use of the Assets or operation of the Food Service Counter located at _____ after the Closing Date.

9. Termination.

9.1 Events of Termination. This Agreement and the transactions contemplated hereby may be terminated at any time prior to the Closing Date: (a) by Buyer, if any of the conditions in Section 6 shall have become incapable of satisfaction or shall not have been satisfied or performed in the manner and within the time required on or before the Closing Date; and shall not have been waived by Buyer; or (b) by Seller, if any of the conditions in Section 7 shall have become incapable of satisfaction or shall not have been satisfied or performed in the manner and within the time required on or before the Closing Date; and shall not have been waived by Seller.

9.2 Effects of Termination. In the event of termination pursuant to this Section 9, or by virtue of the closing not having occurred by _____, 20____, other than as a result of a breach by Seller or Buyer of its covenants contained herein, or the non-fulfillment by Seller or Buyer of a condition in Section 6 or 7 to be fulfilled by Seller or Buyer, in each case solely within its control, this Agreement shall thereafter become void and of no further force and effect.

10. Miscellaneous.

10.1 Headings; Meanings. Section numbers and headings in this Agreement are for convenience only and shall not affect in any way the meaning or interpretation of this Agreement. The provisions of this Agreement shall be interpreted in accordance with their fair meanings, and shall not be strictly construed for or against either party.

10.2 Severability. The invalidity or unenforceability of any particular provision of this Agreement shall not affect the other provisions, and this Agreement shall be construed in all respects as if any invalid or unenforceable provision were omitted.

10.3 Arbitration: Except as precluded by applicable law, any controversy or claim that arises out of or relates to this Agreement, or any breach of this Agreement, including without limitation any claim that any of this Agreement (including this Paragraph 10.3) is invalid, illegal, voidable or void, shall be submitted to arbitration in accordance with the rules of the American Arbitration Association and judgment on the award may be entered in any court with jurisdiction thereof. Unless applicable law requires otherwise, arbitration shall occur in Los Angeles, California. This arbitration provision shall be

self-executing, and shall remain in effect after and regardless of expiration or termination of this Agreement. If a party fails to appear at any properly noticed arbitration proceeding, an award may be entered against such party regardless of such failure to appear. The prevailing party in any arbitration or other proceeding shall be entitled to recover its reasonable attorneys' fees and costs.

10.4 Governing Law. The validity, construction and performance of this Agreement shall be governed by the laws, without regard to the laws as to choice or conflict of laws, of the State of California.

10.5 Entire Agreement. This Agreement, including its Exhibits is the entire agreement between the parties on its subject matter, and supersede all prior agreements, understandings, negotiations, representations and discussions, whether verbal or written pertaining to the subject. There are no promises, terms, conditions or obligations of the parties pertaining to that subject matter other than as contained in this Agreement. Nothing in this Agreement is intended to disclaim the representations made to Buyer in the Franchise Disclosure Document.

10.6 Binding Effect. This Agreement shall bind and benefit the parties and their successors and permitted assigns.

10.7 Parties in Interest. Nothing in this Agreement, expressed or implied, is intended to confer on any person or entity other than the parties any right or remedy under or by reason of this Agreement.

10.8 Notices. Any notice or communication required or permitted by this Agreement shall be deemed sufficiently given if in writing and when delivered personally or 48 hours after deposit with the U.S. Postal Service as registered or certified mail, postage prepaid, and addressed as follows:

If to Buyer:

Attention: _____

If to Seller:

Advanced Fresh Concepts Corp.
19700 Mariner Avenue
Torrance, California 90503
Attention: Vincenzo Calcagni

or such other address as a party to whom notice is to be given has furnished to the other party in the manner provided above.

10.9 Amendments and Waiver. This Agreement may be amended, modified or supplemented only by a writing executed by each of the parties.

Signed as of the date first written above.

BUYER

Signature

Title

SELLER

ADVANCED FRESH CONCEPTS CORP.

By _____

Its _____

EXHIBIT A

ASSETS

EXHIBIT J

**FOOD SERVICE COUNTER TRANSFER
AGREEMENT**

FOOD SERVICE COUNTER TRANSFER AGREEMENT

This FOOD SERVICE COUNTER TRANSFER AGREEMENT is entered into this ____ day of _____, 20__, by and between _____ (“Buyer”), and Advanced Fresh Concepts Franchise Corp., a California corporation, or its Designee or Affiliate (“Seller”).

RECITALS

Seller operates a Zenshi Counter/AFC Food Service Counter/Wild Blue Counter (the “Food Service Counter”) at _____ (the “Location”). Buyer wants to purchase from Seller, and operate, the business of, the Food Service Counter. Seller is willing to sell and transfer the business of the Food Service Counter to Buyer according to the terms of this Agreement. Accordingly, the parties have agreed as follows:

AGREEMENT

1. Transfer. Seller transfers to Buyer the business of the Food Service Counter, other than its tangible assets, effective _____, 20__ (“Effective Date”).
2. Price. Buyer shall pay Seller \$ _____, and assume and be responsible for the following liabilities and obligations _____.
3. Payment. Buyer shall pay the purchase price stated in Section 2 in cash or cashier’s check on signing this Agreement.
4. Obligations to Personnel. Seller shall be responsible to pay all compensation and benefits due to personnel of the Food Service Counter for services before the Effective Date.
5. Indemnification. Buyer shall indemnify, defend and hold Seller harmless from and against all damages, losses, liabilities, claims or expenses, also including court costs and attorneys’ fees, arising from use and operation of the Food Service Counter after the Effective Date.
6. Buyer Acknowledgements. Buyer acknowledges being aware that:
 - A. the transfer accomplished by this Agreement does not include any tangible assets, equipment or inventory of the Food Service Counter. The sale, transfer and assignment of any assets, equipment and/or inventory to operate the Food Service Counter shall be accomplished by a separate Bill of Sale, on terms agreed by the parties;
 - B. Buyer will be required to sign and comply with other agreements and instruments to be permitted to operate the Food Service Counter, including but not limited to a Franchise Agreement and other ancillary agreements;
 - C. the transfer accomplished by this Agreement is conditioned on the property owner or landlord’s consent to the transfer; permission to operate the Food Service Counter at the Location is derived from an agreement between Seller (or an entity affiliated with Seller, such as Advanced Fresh Concepts Corp.) and the owner or lessor of the Location; that agreement may be modified or terminable by the owner and/or manager of the Location at any time and on short notice; the owner or facility manager may object to Buyer operating there; and modification, termination or objection by the owner or facility manager may result in the need for relocation and resulting disruption and interruption to Buyer or adjustment to the franchise operations (such as if the facility

owner requests that operations be converted from a full time location to a self-service, or part time location, or vice versa).

D. Seller makes no warranty or representation about the length of time Buyer may be permitted to operate the Food Service Counter at the Location or any other warranty or representation of any kind.

7. Interpretation. Section numbers and headings in this Agreement are for convenience only and shall not affect the meaning or interpretation of this Agreement. The provisions of this Agreement shall be interpreted according to their fair meanings, and shall not be strictly construed for or against either party.

8. Severability. The invalidity or unenforceability of any provision of this Agreement shall not affect the other provisions; they shall remain in effect and this Agreement shall be construed as if any invalid or unenforceable provision were omitted.

9. Governing Law. The validity, construction and performance of this Agreement shall be governed by California law, without regard to rules on choice or conflict of laws.

10. Arbitration: Any controversy or claim that arises out of or relates to this Agreement, or any breach of this Agreement, including without limitation any claim that any of this Agreement (including this Section 10) is invalid, illegal, voidable or void, shall be submitted to arbitration in accordance with the rules of the American Arbitration Association and judgment on the award may be entered in any court having jurisdiction. Arbitration shall occur in Los Angeles, California. This arbitration provision shall be self-executing, and shall remain in effect after and regardless of expiration or termination of this Agreement. If a party fails to appear at any properly noticed arbitration proceeding, an award may be entered against such party regardless of such failure to appear. The prevailing party in any arbitration or other proceeding shall be entitled to recover its reasonable attorney's fees and costs.

11. Parties in Interest. This Agreement shall bind and benefit the parties and their successors and permitted assigns. Nothing in this Agreement, expressed or implied, is intended to confer on any person or entity other than the parties any right or remedy under or by reason of this Agreement.

12. Notices. Any notice or communication required or permitted by this Agreement shall be deemed sufficiently given if in writing and when delivered personally or 48 hours after deposit with the U.S. Postal Service as registered or certified mail, postage prepaid, and addressed as follows:

To Buyer:

Attention: _____

To Seller:
Advanced Fresh Concepts Franchise Corp.
19700 Mariner Avenue

Torrance, California 90503
Attention: Vincenzo Calcagni

or other address that a party to whom notice is to be given has notified the other party as provided above.

13. Entire Agreement. This Agreement is the entire agreement between the parties on its subject matter, and supersedes all prior agreements, understandings, negotiations, representations and discussions, whether verbal or written pertaining to the subject. There are no promises, terms, conditions or obligations of the parties pertaining to that subject matter other than as contained in this Agreement. Nothing in this Agreement is intended to disclaim the representations made to Buyer in the Franchise Disclosure Document. This Agreement may be amended, modified or supplemented only by a writing executed by each of the parties.

Signed as of the date first written above.

BUYER

SELLER

ADVANCED FRESH CONCEPTS
FRANCHISE CORP.

Signature

By _____

Title

Its _____

EXHIBIT K

PROMISSORY NOTE

PROMISSORY NOTE

\$ _____, 20__

FOR VALUE RECEIVED, _____ (“Maker”), hereby promises to pay to ADVANCED FRESH CONCEPTS FRANCHISE CORP., a California corporation (“Holder”), or order, at _____, or at such other place as Holder may from time to time designate in writing, the principal sum of _____ Dollars (\$ _____), with interest on the unpaid principal balance of this Promissory Note (“Note”) from the date of this Note until paid in full at the rate of zero percent (0%) per annum (“Interest Rate”).

1. Payment. Principal under this Note is payable as follows:
 - (i) On the _____ day of each month following the date of this Note, Maker shall pay to Holder monthly installments of principal in the amount of _____ Dollars (\$ _____).
 - (ii) On _____, the entire unpaid principal balance of this Note shall be due and payable.
 - (iii) Maker shall pay the sums due either by cashier’s check, money order, credit card or at Holder’s option, via deduction from commissions due to Maker.
2. Prepayment. This Note is prepayable, in whole or in part, at any time by Maker upon thirty (30) days’ written notice to Holder.
3. Late Charge and Default Rate. Maker recognizes that any default in the payment of any installment of principal due hereunder will result in losses and additional expenses to Holder in servicing the indebtedness evidenced hereby, handling such delinquent payments and meeting its financial obligations, and that the damages caused thereby would be extremely difficult and impractical to ascertain. Therefore, if any installment of principal due hereunder becomes overdue for a period more than ten (10) days, a late charge of one percent (1%) of the delinquent amount may be charged by Holder, at its option, to defray such losses and expenses. If applicable law requires a lesser charge, the maximum rate permitted by law may be charged. Any late charge that accrues during a month shall be payable on the next monthly payment date. Maker agrees that the payment of the late charge set forth in this Paragraph 3 is a reasonable estimate of the damage to Holder in the event of a late payment. The late fee provided in this Paragraph shall be payable in addition to all other remedies of Holder hereunder, at law or in equity.
4. Acceleration. If Maker fails to pay any installment within ten (10) days after the same is due, or if any other default occurs under this Note, or any other Franchise Agreement or addendum between the parties, the entire unpaid principal balance and other sums payable hereunder shall, at the option of Holder, become immediately due and payable without demand or notice.
5. Application of Payments; No Setoffs. All sums payable hereunder shall be payable without offset, demand, abatement or counterclaim of any kind or nature whatsoever, all of which are hereby waived by Maker. Principal shall be payable in lawful money of the United States of America.
6. Waiver. Maker and all other parties who may be directly or indirectly liable hereunder waive (a) presentment, protest and demand, diligence in collection and notice of protest, presentment,

demand, dishonor and nonpayment of this Note and (b) any release or discharge arising from any extension of time, discharge of any party liable for payment of this Note, release of any or all of the security for this Note, or other cause of release or discharge other than actual payment in full of this Note.

7. No Waiver. Holder shall not be deemed, by any act or omission, to have waived any of its rights or remedies hereunder unless such waiver is in writing and signed by Holder and then only to the extent specifically set forth in such writing. A waiver with reference to one event shall not be construed as a bar to or waiver of any right or remedy as to any subsequent event. No delay or omission of Holder to exercise any right, whether before or after a default hereunder, shall impair any such right or shall be construed to be a waiver of any right or default, and the acceptance at any time by Holder of any past-due amount shall not be deemed to be a waiver of the right to require prompt payment when due of any other amounts then or thereafter due and payable.

8. Severability. Any provision of this Note which may be prohibited by law or otherwise held invalid shall be ineffective only to the extent of such prohibition or invalidity and shall not invalidate or otherwise render ineffective the remaining provisions of this Note.

9. Choice of Law. This Note, and the rights and obligations hereunder of each of the parties hereto, shall be governed by and construed in accordance with the laws of the State of California, without reference to principles of conflicts of law.

10. Successors and Assigns. The terms, covenants and conditions contained herein shall be binding upon the heirs and successors of Maker and shall inure to the benefit of the successors and assigns of Holder.

11. Costs and Expenses. If any amount under this Note is not paid when due, Maker promises to pay immediately upon demand all costs and expenses of collection, including without limitation actual attorneys' fees, incurred by Holder to enforce the terms of this Note.

12. Venue and Jurisdiction. Maker agrees that any suit, action or proceeding arising out of or relating to this Note, or the interpretation, performance or breach of this Note, may be instituted in the United States District Court for the Central District of California or any court of the State of California located in Los Angeles County, and Maker irrevocably submits to the jurisdiction of those courts and waives any and all objections to jurisdiction or venue that it may have under the laws of the State of California or otherwise in those courts in any such suit, action or proceeding. The provisions of this paragraph shall not be deemed to preclude Holder from filing any suit, action or proceeding in any other appropriate forum.

13. Assignment. Holder may assign this Note and any security for this Note without notice to Maker or the consent of Maker. Maker shall have no right or power to assign or delegate any obligations under this Note.

14. Entire Agreement. This Note contains all of the terms and conditions agreed on by Maker and Holder with respect to the subject matter of this Note. This Note supersedes all prior negotiations, understandings, representations, and agreements between Maker and Holder on its subject. Nothing in this Note is intended to disclaim the representations made to Maker in the Franchise Disclosure Document. This Note cannot be modified or changed except by written instrument signed by Maker and Holder.

15. Miscellaneous. If this Note is executed by more than one person or entity as Maker, the obligations of each such person or entity shall be joint and several. Each right, power and remedy of Holder

provided in this Note, any other document securing this Note or at law, in equity or otherwise shall be cumulative and may be pursued singularly, successively or together at the sole discretion of Holder, and the failure to exercise any such right, power or remedy shall in no event be construed as a waiver or a release thereof.

Time is of the essence with respect to each and every provision hereof in which time is a factor.

MAKER

Signature

Print Name

Title

EXHIBIT L

TABLE OF CONTENTS OF OPERATING MANUAL, SSOP MANUAL, STEAM TABLE MANUAL AND RECIPE GUIDES

TABLE OF CONTENTS

STANDARD OPERATION MANUAL



BOD BUSINESS OPERATION DEPARTMENT

	BOD	PAGE
A. Sushi Bar Business Hours	BOD	1
B. Store Relationship	BOD	1
C. Sushi Bar Personnel	BOD	1
D. AFC Supervision	BOD	2
E. Supervision Report	BOD	2
Inspection Reports	BOD	2
Retraining	BOD	2
F. LABELING	BOD	3
DISPOSAL OF LEFTOVER SUSHI	BOD	3
G. Fish, Seafood, Vegetables and Spicy Sauce	BOD	3 – 4
Thawing Procedure		
Preparing Seafood		
Shrimp		
Vegetables		
Carrots		
Spicy Sauce		
Sushi Specification Charts	BOD	5 – 9
Sushi Layout Charts	BOD	10 – 17
H. Daily Production Report (DPR)	BOD	18 – 22
Sample DPR (R-1 & R-2)B	BOD	20
Sample DPR (R-2)B	BOD	21
Sample DPR (NA1)	BOD	22
I. How to Use Sushi Related Products Movement Log	BOD	23
Sushi Related Products Item Movement Log		25
J. Delivery to Self Service Sushi Bars	BOD	26
Equipment	BOD	
Instructions	BOD	
Care for Equipment	BOD	
DELIVERY SUSHI TEMPERATURE LOG	BOD	27
K. Glossary of Terms	BOD	28
L. Sushi Rice Procedure	BOD	29
M. Short Grain Rice	BOD	30
N. Musenmai-Premium	BOD	30
O. Packaging and Cooling	BOD	31
P. Over night chilled cooling procedure	BOD	31
SUSHI	BOD	33

TABLE OF CONTENTS

STANDARD OPERATION MANUAL



BOD (continued)	PAGE
CUSTOMER SERVICE	
SALES PROMOTION	BOD 34
DEMO/SAMPLING	BOD 35
Preparation	BOD 36
Sushi Related Products	BOD 36
Other Materials	
HOW TO DEMO	BOD 37 – 38
Introduction to AFC	
The Secret of Good Sushi	
Sushi Rice	
Roll Size	BOD 39
How to Make Rolls	BOD 40 – 42
Presentation	BOD 43
Variations of Maki Sushi	BOD 43
HAND ROLL	BOD 44 – 45
Variations	
SUSHI CHEFS	BOD 46
Frequency of Demos	
Timing	
Natural and Sushi Related	
DEMO/SAMPLING Data Sheet	BOD 47
Roll'n Wrap	BOD 48 – 65
Hot Bowl Instruction	BOD 65 – 77

TABLE OF CONTENTS

STANDARD OPERATION MANUAL



ACT ACCOUNTING DEPARTMENT

		PAGE
ACCOUNTING PROCEDURE	ACT	1 - 2
Personal Information		
Your Name		
Sales Reporting and Remittance		
IMPORTANT TAX INFORMATION	ACT	3
IDENTIFICATION NUMBER AND	ACT	4
CERTIFICATION W-9 FORM		
SALES REPORT FORM (SAMPLE)	ACT	5
STATEMENT (model)	ACT	6
EXPLANATION ON SAMPLE COMMISSION	ACT	7
STATEMENT		
MONTHLY CLOSING DATE	ACT	8
CHANGE OF ADDRESS AND	ACT	9
INFORMATION		
SALES DISCREPANCIES CLAIM	ACT	10
REFERENCE		
SALES DISCREPANCIES CLAIM FORM	ACT	11
(SAMPLE)		

TABLE OF CONTENTS

STANDARD OPERATION MANUAL



MKT MARKETING DEPARTMENT

		PAGE
INTRODUCTION	MKT	1
CUSTOMER SERVICE	MKT	2
Be Friendly		
Be Knowledgeable About Your Products	MKT	2
Establish Relationship with Your Customer	MKT	3
Be Helpful		
Be Clean and Neat		
Adjust your Working Hours	MKT	4
DEMOS	MKT	5
CUSTOMER COMPLAINT	MKT	6
Product Dissatisfaction		
Food Poisoning		
MERCHANDISING	MKT	7
Sushi		
Natural Products	MKT	8
Display Case		
Shrink		
For the Customers	MKT	9
Advertising		
SUMMARY	MKT	10

TABLE OF CONTENTS

STANDARD OPERATION MANUAL



LEG LEGAL DEPARTMENT

		PAGE
LABELS & LOGS	LEG	1
PRICE LABELS	LEG	2
Bar Code		
Ingredients		
Net Weight		
Positioning		
HARRASSMENT POLICY	LEG	3 – 4
ACCIDENT PREVENTION & ACTION for EMERGENCIES MANUAL	LEG	5 – 14

DISTRIBUTION CENTER

		PAGE
ORDER PROCEDURE	DC	1
RECEIVING INSTRUCTIONS		
URGENT ORDERS		
BACK ORDER	DC	2
RECEIVING PROCEDURE		
QUALITY ASSURANCE		
FIFO (First In First Out)		
BILL OF LADING (SAMPLE)	DC	3
AFC MISSING / DAMAGED ITEM CLAIM REPORT (form)	DC	4
Missing Items	DC	5
Damaged Items		
Frozen Items		

TABLE OF CONTENTS

STANDARD OPERATION MANUAL



AFC LABEL MACHINE POLICY

		PAGE
GENERAL INFORMATION	Policy	1
Who Must Have The Label Machine? What is Included?		
Costs and Charges		2
Payment		3
Two-year Warranty Terms		3
Precautions / Warnings		
Sushi Chef's Responsibilities		3 - 4
Hot-Spares / Replacements		4 - 5
Label Machine Service Warranty Renewal		6 - 7
How the Label Machine Works		7
Label Revisions		
Adding New Items		
Out of Box defects/ Missing Items		8
RETURN POLICY		9 - 10
Credit Process		
LABEL MACHINE CREDIT FORM		11
LABEL MACHINE INSTRUCTION GUIDE	Guide	12 - 38

APPENDIX (Forms and Logs)

		PAGE
ITEM MOVEMENT LOG	APX	1
DEMO / SAMPLING DATA SHEET	APX	2
SALES REPORT	APX	3
SALES DISCREPENCY FORM	APX	4
CHANGE OF ADDRESS	APX	5
MISSING / DAMAGED ITEMS FORM	APX	6
ILLNESS POLICY	APX	7
FRANCHISEE COMMUNICATION FORM	APX	8



Table of Contents

Page	Content
5	Kitchen Setup
6-10	Recommended Equipment
11	Ingredient Shelf Life
12-13	Ingredient Size Specifications
14-15	Approved Ingredients
16-21	Menu Planograms
	Recipes
22	- Garlic Ginger Mix
23	- Sushi Rice Procedure
24	- Rice Cooking Procedure
25-31	- Fried Rice/Noodles
32-65	- Entrées
66-75	- Appetizers
76-78	- Soups
79-84	- Marinades



TABLE OF CONTENTS

Sushi Recipe Book

Page	Content
IV	What is Sushi?
V-VI	Sushi Variations
VII-VIII	Ingredients and their Japanese Names
IX	Sushi Knives
X-XIV	Ingredient Shelf Life
XV	Ingredient Preparation
XVI	Approved Brands for Specified Ingredients Purchased Locally
XVII	Sushi Product and Trays Disclaimer
XVIII	Alternate Product Names
	Recipes
1-17	- Classic
18-31	- Combo
32-50	- One Roll
51-67	- Hybrid
68-83	- Wraps
84-100	- Samplers
101-110	- Party Trays
111-119	- Bowls
120-125	- Appetizers

TABLE OF CONTENTS

Sushi Recipe Book

Page	Content
IV	What is Sushi?
V-VI	Sushi Variations
VII-VIII	Ingredients and their Japanese Names
IX	Sushi Knives
X-XIV	Ingredient Shelf Life
XV	Ingredient Preparation
XVI	Approved Brands for Specified Ingredients Purchased Locally
XVII	Sushi Product and Trays Disclaimer
	Recipes
1-4	- Classic
5-19	- Nigiri
20-44	- 10 pcs
45-53	- 15 pcs
54-70	- Hybrid
71-88	- Wraps
89-133	- Combo
134-143	- Party Trays
144-157	- Bowls
158-162	- Appetizers

Franchisee Name: _____

Franchisee ID: _____

Store Name/Number: _____



OXOXOX

Standard Sanitation Operating Procedure

& Methods Manual

pH 135

Table of Contents

Introduction	1
AFC Manuals	1
T.T.C. vs. pH Controlled Locations	1
Daily Logs	2
Rules for Providing Safe Food	2
Personal Hygiene & Personal Cleanliness	2
Handling Employee Illnesses	4
Storage of Personal Belongings	6
Equipment	7
Thermometers	8
Purchasing Food and Supplies	9
Letters of Guarantee	9
Flow of Food	10
Food Storage	10
Receiving	12
Food Allergens	13
Food Preparation	14
Cooling Food	16
Defrosting	17
Protecting Food During Service	17
Food Sampling	18
Proper Labeling	20
Shelf Life	21
Cleaning & Sanitizing	22
Chemical Storage	24
Maintenance of Shared Spaces	25
Pest Control	25
HACCP	26
Laboratory Analysis of Sushi	27
Consumer Advisory	27
ServSafe® & Food Handler's Certificate	27
Food Service - Business License / Health Permit to Operate	28
The Helper	28
Inspection Reports from Enforcement Agencies	28
AFC Internal Audits	28
Delivery Locations	29
Additional Store Requirements	29
Questions?	29

EXHIBIT M

LIST OF U.S. FRANCHISEES, U.S. COMPANY OWNED LOCATIONS, TRANSFERS, TERMINATIONS, NON- RENEWALS, CEASED OPERATIONS/OTHER IN OUR LAST FISCAL YEAR

Zenshi Food Service Counters

Franchise List

As of March 31, 2025

Franchisee Name	Address	City	State	Zip	Phone
MACAPINLAC, Jessel Co	700 E Northern Lights Blvd	Anchorage	AK	99503	(208) 395-6200
KEOKHAMPHOUY, Anouxa	1650 W. Northern Lights Blvd.	Anchorage	AK	99517	(907) 339-0500
DEANO, Leilanie Asuncion	5600 Debarr Road	Anchorage	AK	99504	(907) 339-0900
NGEWTONG, Nampueng	7731 E. Northern Lights Blvd	Anchorage	AK	99504	(907) 339-1700
GALINDO, Mario Ildelfonso, Jr.	1725 Abbott Rd	Anchorage	AK	99507	(907) 339-2800
FARNEN, Kenia Alcantara	5800 Westover Ave.	Anchorage	AK	99506	(907) 580-4863
TANGBOU, Zaugun	11409 Business Park Blvd	Eagle River	AK	99577	(907) 696-9400
TANGBOU, Zaugun	11409 Business Park Blvd	Eagle River	AK	99577	(907) 696-9400
THIKE, Aung Myo	2540 CENTRAL AVE STE 100	Eielson AFB	AK	99702-2399	(907) 377-2148
KAP, Thawng	Bldg 3703A 3703 Santiago Ave.	Fort Wainwright	AK	99703	(907) 353-6218
PAU, Sawm	90 Sterling Hwy	Homer	AK	99603	(907) 226-1000
KIM, Dal Khan	3033 Vintage Blvd	Juneau	AK	99801	(907) 523-2000
SANG, Thang Sian Muan	2417 Tongass Ave	Ketchikan	AK	99901	(907) 228-1900
CHAVEZ, Charmaine Javier	2685 Mill Bay Rd.	Kodiak	AK	99615	(907) 481-1500
GALINDO, Kim Allen De Guzman	301 N. Santa Claus Lane	North Pole	AK	99705	(907) 490-2700
GALINDO, Kim Allen De Guzman	301 N. Santa Claus Lane	North Pole	AK	99705	(907) 490-2700
TADAUNG, Nattikarn	664 West Evergreen Ave	Palmer	AK	99645	(907) 761-1400
LIAN TAWNG, David	44428 Sterling Highway South	Soldotna	AK	99669	(907) 714-5400
LIAN TAWNG, David	44428 Sterling Highway South	Soldotna	AK	99669	(907) 714-5400
VILORIA, Izy Gayle	595 E. Parks Hwy	Wasilla	AK	99654	(907) 352-1100
VILORIA, Izy Gayle	595 E. Parks Hwy	Wasilla	AK	99654	(907) 352-1100
HLA, Kyaw Tun	9200 Highway 119 Ste 1400	Alabaster	AL	35007	(205) 663-3443
HLA, Kyaw Tun	9200 Highway 119 Ste 1400	Alabaster	AL	35007	(205) 663-3443
MOH, Khin Moh	4812 Hwy 280	Alexander City	AL	35010	(863) 688-1188
BIK, Jonathan Thawngluai	22031 US Highway 72	Athens	AL	35613-2614	(256) 230-2076
BIK, Jonathan Thawngluai	22031 US Highway 72	Athens	AL	35613-2614	(256) 230-2076
KAP, Thang Sian	300 Deans Rd. Suite F	Auburn	AL	36830	(334) 821-1325
TUANG, Suan Thawn	2415 Moores Mill Rd	Auburn	AL	36830	(334) 502-8667
MYINT, Phyu Phyu	2900 E University Dr.	Auburn	AL	36830	(334) 502-2416
MYINT, Phyu Phyu	2900 E University Dr.	Auburn	AL	36830	(334) 502-2416
HTWE, Hla	4965 Promenade Parkway	Bessemer	AL	35022	(205) 426-7100
LWIN, Zin Mar	5188 Coldwell Mill	Birmingham	AL	35244	(205) 980-7500
SHEIN, Kyawt Kyawt	1944 Montgomery Hwy S	Birmingham	AL	35244	(205) 987-3401
SHEIN, Kyawt Kyawt	1944 Montgomery Hwy S	Birmingham	AL	35244	(205) 987-3401
NGAI, Ling	1325 Montclair Rd.	Birmingham	AL	35210	(205) 951-6626
SHEIN, Kyawt Kyawt	1944 Montgomery Hwy S	Birmingham	AL	35244	(205) 987-3401
LWIN, Zin Mar	5188 Coldwell Mill	Birmingham	AL	35244	(205) 980-7500
LWIN, Zin Mar	5188 Coldwell Mill	Birmingham	AL	35244	(205) 980-7500
LUN, Magdalene Thang Zam	3040 Healthy Way	BIRMINGHAM	AL	35243	(205) 970-7501
MYAT, Htin Lin Min	2860 Lakeshore Pkwy	Birmingham	AL	35211	(205) 945-2741
LANGLE, Billy K	6219 Tattersall Blvd.	Birmingham	AL	35242	(205) 778-5381
MANG, Anthony Khualza	90 Marketplace Cir	Calera	AL	35040	(205) 668-3585
ZASIAH, Stephen Vantiam	501 Chelsea Crossroads	Chelsea	AL	35043	(205) 678-5600
ZASIAH, Stephen Vantiam	501 Chelsea Crossroads	Chelsea	AL	35043	(205) 678-5600
PAU, Thang Vum	1104 Cullman Shopping Center NW	Cullman	AL	35055	(256) 736-7000
LING, Tluang Thang	1605 Beltline Rd. SW	Decatur	AL	35601	(256) 301-0023
NANG, James	2934 Point Mallard Pkwy, SE	Decatur-Morgan	AL	35603	(256) 351-5261
MUNG, Thawng Ngaih	3525 Ross Clark Circle	Dothan	AL	36303	(334) 792-4281
MUANG, Thian Pek	1620 Ross Clark Circle	Dothan	AL	36301	(334) 673-1200
HNIEM, Biak	4650 West Main Street Ste 700	Dothan	AL	36305	(334) 792-6801
KHUP, Phung Go	847 Boll Weevil Cir	Enterprise	AL	36330	(334) 348-1489
MANG, Thang Suan	22530 U.S.Highway 98	Fairhope	AL	36532	(251) 929-7355
MANG, Thang Suan	22530 U.S.Highway 98	Fairhope	AL	36532	(251) 929-7355
MANG, Thang Suan	22530 U.S.Highway 98	Fairhope	AL	36532	(251) 929-7355
MANG, Thang Suan	22530 U.S.Highway 98	Fairhope	AL	36532	(251) 929-7355
LIN, Cung Hu	18125 Wright Blvd	Fairhope	AL	36532	(251) 279-6442
THANG, Ting Zung	322 Cox Creek Pkwy	Florence	AL	35630	(256) 718-1790
AUNG, Wai Phyo	2614 S. McKenzie St.	Foley	AL	36535	(251) 943-3329
SIAM, Gin	BLDG 9213 HUTTON PLAZA RD	Fort Rucker	AL	36362	(334) 255-3430
Hnin, Wai Wai	655 Fieldstown Road	Gardendale	AL	35071	(205) 608-4677
LIAN, Pau Deik	160 Cotton Creek Drive	Gulf Shores	AL	36542	(251) 948-1281
LIAN, Pau Deik	160 Cotton Creek Drive	Gulf Shores	AL	36542	(251) 948-1281
MUNG, Thawng Za	2300 Gunter Avenue	Guntersville	AL	35976	(256) 571-2501
Thang, Kham Lian	5850 Highway 53	Harvest	AL	35749	(256) 851-5958
Thang, Kham Lian	5850 Highway 53	Harvest	AL	35749	(256) 851-5958
MANG, Hau Lan	411 Green Springs Hwy	Homewood	AL	35209	(205) 944-1101
MAUNG, Salai K	2543 John Hawkins Pkwy	Hoover	AL	35244-3533	(205) 982-8506
MYAT, Arkar Min	4289 South Shades Crest Road	Hoover	AL	35244	(205) 428-4923
CIN ZAH, Tluang Bawi Chin Par	3014 Allison Bonnett Memorial Dr	Hueytown	AL	35023	(205) 497-5366
CIN ZAH, Tluang Bawi Chin Par	3014 Allison Bonnett Memorial Dr	Hueytown	AL	35023	(205) 497-5366
NUNG, Joseph	2110 Oakwood Ave NW	Huntsville	AL	35810	(256) 536-0715

Zenshi Food Service Counters

Franchise List

As of March 31, 2025

Franchisee Name	Address	City	State	Zip	Phone
NUNG, Joseph	2110 Oakwood Ave NW	Huntsville	AL	35810	(800) 576-4377
VUNG, Hrang	7090 University Drive	Huntsville	AL	35806	(256) 726-0600
CHANG, Elle	12796 Bailey Cove Rd SE	Huntsville	AL	35803	(256) 885-0002
MAUNG, Tun	4851 Whitesburg Dr.	Huntsville	AL	35802	(256) 650-2390
NYEIN, Ei Ei	2246 Winchester Rd NE	Huntsville	AL	35811	(256) 851-5807
CHANG, Elle	12796 Bailey Cove Rd SE	Huntsville	AL	35803	(256) 885-0002
HMUNG, Biak Nuai	2286 Zierdt Rd.	Huntsville	AL	35824	(256) 774-3888
CHANG, Elle	12796 Bailey Cove Rd SE	Huntsville	AL	35803	(256) 885-0002
THANG, Za Len	9040 Memorial Pkwy SW	Huntsville	AL	35802	(256) 650-6086
NGUNHEI, Tan Thay Aung	4579 Wall Triana Highway	Madison	AL	35758	(256) 461-0914
JONES, Jinyan Y.	12070 County Line Road	Madison	AL	35756	(256) 230-2626
BAWI, Rosy Dim	115 N. Turner Blvd	Maxwell- Gunter AFB	AL	36114	(334) 416-7920
BAWI, Rosy Dim	115 N. Turner Blvd	Maxwell- Gunter AFB	AL	36114	(334) 416-7920
PYONE, Thidar	1400 AL Hwy 14	Millbrook	AL	36054	(334) 604-4819
MANG, Vungh Suan	4628 Airport Blvd.	Mobile	AL	36608	(251) 341-5727
KHAN, Pau Za	2370 Hillcrest Rd, Unit J	Mobile	AL	36695	(251) 661-5361
Qader, Matthew M	100 N Florida Street	Mobile	AL	36607	(251) 471-4860
Qader, Matthew M	100 N Florida Street	Mobile	AL	36607	(251) 471-4860
Qader, Matthew M	100 N Florida Street	Mobile	AL	36607	(251) 471-4860
KHUAL, Gin Sian	9124 Cottage Hill Road	Mobile	AL	36695	(800) 242-1227
THIT, Jun Hnine Thin M	7076 Atlanta Hwy	Montgomery	AL	36117	(334) 290-4501
QU, Ying	4045 Atlanta Hwy	Montgomery	AL	36109	(334) 260-7782
THIT, Jun Hnine Thin M	7076 Atlanta Hwy	Montgomery	AL	36117	(334) 290-4501
QU, Ying	4045 Atlanta Hwy	Montgomery	AL	36109	(334) 260-7782
WANG, Yinghong	2200 Village Drive	Moody	AL	35004	(205) 640-3230
NHKUM, Ring Tey	3220 Woodward Ave.	Muscle Shoals	AL	35661	(256) 389-0080
TUN, Thu Zar	2300 McFarland Blvd	Northport	AL	35476	(205) 339-4232
TUN, Thu Zar	2300 McFarland Blvd	Northport	AL	35476	(205) 339-4232
PIANG, Cin Dain	2450 Enterprise Dr.	Opelika	AL	36801	(334) 737-2643
LIN, Gin Sawn	25771 Perdido Beach Blvd	Orange Beach	AL	36561	(251) 980-1404
LIN, Gin Sawn	25771 Perdido Beach Blvd	Orange Beach	AL	36561	(251) 980-1404
SINT, Ye Htut Win	6707 HWY 431 S	Owens Cross Roads	AL	35763	(256) 512-0990
SINT, Ye Htut Win	6707 HWY 431 S	Owens Cross Roads	AL	35763	(256) 512-0990
SHRING, Salai	115 Commons Way	Oxford	AL	36203	(256) 835-4075
NEI, Van	2040 Martin St S	Pell City	AL	35128	(205) 338-3472
LE, Phuong	5408 Summerville Rd	Phenix City	AL	36867	(334) 291-8525
KHAI, Hang Lian	5150 Old Springville Rd	Pinson	AL	35126	(205) 815-5224
KHAI, Hang Lian	5150 Old Springville Rd	Pinson	AL	35126	(205) 815-5224
AUNG, SKYLER	2451 Cobbs Ford Road	Prattville	AL	36066	(334) 285-0227
AUNG, SKYLER	2451 Cobbs Ford Road	Prattville	AL	36066	(334) 285-0227
TIN, Tha	128 W Grand Ave	Rainbow City	AL	35906	(256) 442-2581
SUNG, Sung	Acton Drive Bldg 3224	Redstone Arsenal	AL	35898	(256) 876-3517
TUNG, Tuan Sian	2035 SCHILLINGER RD N, SUITE 100	SEMMES	AL	36575-7417	(863) 688-1188
ZAMANG, Avan	165 MCS Boulevard	Sylacauga	AL	35150	(800) 242-1227
TAANG, Pau Sian	1147 U.S Highway 231 South	Troy	AL	36081	(334) 807-5761
SAW, Steven	1101 Southview Lane	Tuscaloosa	AL	35405	(205) 247-7710
CHUNG, Ngun	4851 Rice Mine Rd NE Ste 200	Tuscaloosa,	AL	35406	(205) 247-7666
CHUNG, Ngun	4851 Rice Mine Rd NE Ste 200	Tuscaloosa,	AL	35406	(205) 247-7666
Ji, Roi	784 Montgomery Highway	Vestavia Hills	AL	35216	(205) 824-6005
Ji, Roi	784 Montgomery Highway	Vestavia Hills	AL	35216	(205) 824-6005
MON, Saw Ei Ei	5039 US HIGHWAY 231	WETUMPKA	AL	36092	(334) 478-6186
HKUM, Lung	Bldg 790 Sixth Street	Little Rock AFB	AR	72099	(501) 987-6990
CHOI, Kyoung Inn	1637 N Trekkell Rd.	Casa Grande	AZ	85122	(520) 421-7447
WIN, KATY	4970 South Alma School Road	Chandler	AZ	85248	(480) 883-0255
VANG, Zai Mawi	1031 N US Hwy 89	Chino Valley	AZ	86323	(928) 636-8358
MON, Thida	1635 East Cottonwood St	Cottonwood	AZ	86326	(928) 634-3711
MUNG, Peter	1500 E Cedar Ave	Flagstaff	AZ	86004	(928) 774-3774
HU, Thawng	1201 South Plaza Way	Flagstaff	AZ	86001	(928) 779-3401
KYAW, Saw Type Pue	3325 North Hunt Highway	Florence	AZ	85132	(520) 723-0179
MANG, Kham Khen	2170 Arizona St. Bldg 61610,	Fort Huachuca	AZ	85613	(520) 224-6479
MAWI, Angela Tuan Sui	13733 Fountain Hills Blvd.	Fountain Hills	AZ	85268	(480) 837-0287
SIN, Catherine	861 E. Warner Road	Gilbert	AZ	85296	(480) 558-0105
SIN, Catherine	861 E. Warner Road	Gilbert	AZ	85296	(480) 558-0105
MUNG, Tuang	7175 N. 138th Ave.	Glendale	AZ	85307	(623) 935-3821
MARAN, Gum Hkawng La	440 N Estrella Pkwy	Good Year	AZ	85338	(623) 476-1708
THAWNG, Dang Ling	14175 W. Indian School	Goodyear	AZ	85395	(623) 935-3228
KYI, Kyi	9890 S. Estrella Parkway	Goodyear	AZ	85338	(623) 691-6417
NAING, Maung Maung	3970 Stockton Hill Rd	Kingman	AZ	86409	(928) 681-4900
HTOON, Than	1980 McCulloch Pkwy	Lake Havasu	AZ	86403	(928) 854-5300
HTOON, Than	1980 McCulloch Pkwy	Lake Havasu	AZ	86403	(928) 854-5300
CASE, Yong Ye	4316 S. Signal Butte Rd.	Mesa	AZ	85212	(480) 296-7953

Zenshi Food Service Counters

Franchise List

As of March 31, 2025

Franchisee Name	Address	City	State	Zip	Phone
AUNG, Mar Lar	12122 North Rancho Vistoso	Oro Valley	AZ	85755	(520) 297-4344
KIM, Lal Thafam	8240 W. Deer Valley Road	Peoria	AZ	85382	(623) 572-5744
MAWI, Dawt Nei	8010 W. Happy Valley Rd	Peoria	AZ	85383	(877) 723-3929
KIM, Lal Thafam	8240 W. Deer Valley Road	Peoria	AZ	85382	(623) 572-5744
NYI, Nyi	10641 W Olive Ave	Peoria	AZ	85345	(623) 583-7227
NYI, Nyi	10641 W Olive Ave	Peoria	AZ	85345	(623) 583-7227
KHAI, Do Cin	28455 N. Vistancia Blvd	Peoria	AZ	85383	(623) 243-9204
THANG, Hrang Lian	3130 W Carefree Highway	Phoenix	AZ	85086	(623) 582-4985
HTUN, Khine Khin	21001 N Tatum Blvd Suite 76	Phoenix	AZ	85050	(480) 342-8231
THAWN, Tuan Pian	520 W. Osborn Road	Phoenix	AZ	85013	(602) 274-7422
HAU, Ling Sian	550 E Bell Rd	Phoenix	AZ	85022	(602) 863-4194
TUANG, Cin Vel	810 East Glendale Ave	Phoenix	AZ	85020	(602) 331-0134
HAU, Ling Sian	13440 N. 7th St	Phoenix	AZ	85022	(602) 547-1288
TIAL, Ni	1334 East Chandler Blvd	Phoenix	AZ	85048	(480) 283-0032
SUUM, Thang Khan	3132 East Camelback Road	Phoenix	AZ	85016	(480) 273-7871
PAR, Tha Neih	4747 East Greenway Road	Phoenix	AZ	85032	(602) 996-5635
ZAR, Hla Thu	340 E. McDowell	Phoenix	AZ	85004	(602) 252-4538
THANG, Hrang Lian	3130 W Carefree Highway	Phoenix	AZ	85086	(623) 582-4985
THANG, Hrang Lian	3130 W Carefree Highway	Phoenix	AZ	85086	(623) 582-4985
ABDALLAH, Rawda Hussein	18495 E. Queen Creek Rd.	Queen Creek	AZ	85142	(480) 279-2733
KYAW, Aung	11475 E. Via Linda	Scottsdale	AZ	85259	(480) 767-0819
KYAW, Aung	11475 E. Via Linda	Scottsdale	AZ	85259	(480) 767-0819
THAR, Soe Moe	23565 N. Scottsdale Rd.	Scottsdale	AZ	85255	(480) 585-9366
THAR, Soe Moe	23565 N. Scottsdale Rd.	Scottsdale	AZ	85255	(480) 585-9366
SYMMONDS, Chong Ae	20901 N. Pima Road	Scottsdale	AZ	85255	(480) 585-3552
KHAING, Cho Cho	6501 E. Greenway Parkway	Scottsdale	AZ	85254	(480) 991-3317
WIN, Thomas Soe	32551 N. Scottsdale Rd.	Scottsdale	AZ	85266	(480) 595-9844
REM, Tum	10773 North Scottsdale Road	Scottsdale	AZ	85254	(480) 948-6446
NAING, Aye Su	2300 West Highway 89A	Sedona	AZ	86336	(928) 282-0118
JIAN, Jonathan	2190 East Fry Blvd	Sierra Vista	AZ	85635	(520) 459-4204
TAK, Joseph Naing	14551 W Grand Ave	Surprise	AZ	85374	(623) 546-8038
THA, Biak	17230 W Peoria Ave.	Surprise	AZ	85374	(623) 518-1059
THA, Biak	17230 W Peoria Ave.	Surprise	AZ	85374	(623) 518-1059
THA, Biak	17230 W Peoria Ave.	Surprise	AZ	85374	(623) 518-1059
TAK, Joseph Naing	14551 W Grand Ave	Surprise	AZ	85374	(623) 546-8038
LIAM, Biak	2854 N Campbell Ave	Tucson	AZ	85719	(520) 321-1212
CHHA, James Khe	4752 E. Sunrise Drive	Tucson	AZ	85718	(520) 299-3534
PYONE, Cho Cho	7110 N. Oracle Rd.	Tucson	AZ	85704	(520) 575-0949
KHAM, Thawng C	1940 E. Broadway Blvd.	Tucson	AZ	85719	(520) 206-9047
ZAW, Sthan	9100 N. Silverbell	Tucson	AZ	85743	(520) 579-8365
AUNG, Maung Tin Tun	2140 W Grant Rd	Tucson	AZ	85745	(520) 792-0083
BOIH, Kim	9125 East Tanque Verde Rd.	Tucson	AZ	85749	(520) 760-6087
BOIH, Kim	9125 East Tanque Verde Rd.	Tucson	AZ	85749	(520) 760-6087
SUNG, Lian Sian	9460 E Golf Links Rd	Tucson	AZ	85730	(520) 296-0042
SUNG, Lian Sian	9460 E Golf Links Rd	Tucson	AZ	85730	(520) 296-0042
IRELAND, In	5455 East Comanche St.	Tucson	AZ	85707	(520) 790-4341
HTOO, Aj Saw	13380 E Mary Ann Cleveland way	Vail	AZ	85641	(520) 526-7087
KIM, Yu	2652 Jamacha Rd	El Cajon	CA	92019	(619) 670-0101
YOUNG, Hyon Suk	5727 Kanan Rd	Agoura Hills	CA	91301	(818) 889-5429
WAI, San San	867 Island Dr.	Alameda	CA	94502	(510) 523-4788
HUANG, Mei Ting	2227 South Shore Center	Alameda	CA	94501	(510) 863-9000
BAO, Ye	2600 Fifth Street	Alameda	CA	94501	(510) 523-1804
YANG, Qin	200 Alamo Plaza	Alamo	CA	94507	(925) 820-8022
AYE, Kim H.	26901 Aliso Creek Road	Aliso Viejo	CA	92656	(949) 362-3727
KO, Sandar Aye	103 American Canyon Rd.	American Canyon	CA	94503	(707) 649-5150
SANDAR, Aye	711 S Weir Canyon Rd.	Anaheim	CA	92808	(714) 283-8711
Lu, Pin	5600 Santa Ana Canyon Rd.	Anaheim	CA	92807	(714) 998-3751
Lu, Pin	5600 Santa Ana Canyon Rd.	Anaheim	CA	92807	(714) 998-3751
Lu, Pin	5600 Santa Ana Canyon Rd.	Anaheim	CA	92807	(714) 998-3751
LAWI, Nai Lawi Chan Mon	2601 Balls Ferry Rd	Anderson	CA	96007	(530) 527-4997
LAWI, Nai Lawi Chan Mon	2601 Balls Ferry Rd	Anderson	CA	96007	(530) 527-4997
LAWI, Nai Lawi Chan Mon	2601 Balls Ferry Rd	Anderson	CA	96007	(530) 527-4997
MAW, San San	3365 Deer Valley Rd	Antioch	CA	94531	(925) 706-4150
GARNER, Porsche	16 Rancho Del Mar	Aptos	CA	95003	(831) 688-2775
CAO, Xueying	211 E Foothill Blvd.	Arcadia	CA	91006	(626) 357-1942
MARCO, Benadeto	745 W. Naomi Ave.	Arcadia	CA	91007	(626) 446-9483
MYINT, Ohn M	2550 Bell Road	Auburn	CA	95603	(530) 887-3230
SAY, Saw Wah Ler	9000 Ming Avenue	Bakersfield	CA	93311	(661) 663-0595
HTOO, Kyaw Kaw	17601 25th Street	Beale AFB	CA	95903-1723	(530) 634-2422
SAN, Tin Tin	2100 Ralston Ave.	Belmont	CA	94002	(650) 591-0235
LWIN, Wai	1100 El Camino Real	Belmont	CA	94002	(650) 596-1730

Zenshi Food Service Counters

Franchise List

As of March 31, 2025

Franchisee Name	Address	City	State	Zip	Phone
LWIN, Wai	1100 El Camino Real	Belmont	CA	94002	(650) 596-1730
MIN, Tun	9440 Mill St	Ben Lomond	CA	95005	(831) 336-3900
MIN, Tun	9440 Mill St	Ben Lomond	CA	95005	(831) 336-3900
MAR, Saw Myat	50 Solano Square	Benicia	CA	94510	(707) 745-4047
MAR, Saw Myat	50 Solano Square	Benicia	CA	94510	(707) 745-4047
MARAN, Zau Dan Aung	1444 Shattuck Ave.	Berkeley	CA	94709	(510) 526-3086
CUAI, Cuai	42150 Washington Street	Bermuda Dunes	CA	92203	(760) 200-0272
AUNG, Khaing Myat Thu Zar	1190 N. Main St	Bishop	CA	93514	(760) 872-9811
AUNG, Khaing Myat Thu Zar	1190 N. Main St	Bishop	CA	93514	(760) 872-9811
CAO, Jayson Long	305 W. Imperial Hwy	Brea	CA	92821	(714) 529-4505
LIN, Chuck Shin	2600 W. Victory Blvd.	Burbank	CA	91505	(818) 845-5914
KIM, Yunhee	1100 N San Fernando Blvd	Burbank	CA	91504	(818) 845-6424
MIN, Kyaw	1477 Chapin Ave.	Burlingame	CA	94010	(650) 558-9992
MIN, Kyaw	1477 Chapin Ave.	Burlingame	CA	94010	(650) 558-9992
HUANG, Shun Qin	1450 Howard Ave	Burlingame	CA	94010	(650) 343-3488
CHUNG, Chan Hung	4754 Commons Way	Calabasas	CA	91302	(818) 223-0284
KYAING, Myint	3380 Coach In	Cameron Park	CA	95682	(530) 676-6930
HEIN, Tun Min	950 West Hamilton	Campbell	CA	95008	(408) 871-1272
KO, Sam Sai	19340 Soledad Canyon Rd	Canyon Country	CA	91351	(661) 252-6226
MYINT, Nyunt Win	16550 Soledad Canyon Rd.	Canyon Country	CA	91387	(661) 252-3838
ZEINALI, Namsoon	7140 Avenida Encinas	Carlsbad	CA	92011	(760) 431-1060
BAEK, Min	6951 El Camino Real	Carlsbad	CA	92009	(760) 431-0157
BYUN, Sue	3439 Via Montebello	Carlsbad	CA	92009	(760) 633-0114
THU YA, Myat	5 Crossroads Blvd	Carmel	CA	93923	(831) 625-8820
DAKHUM, Changbe	4040 Manzanita Ave	Carmichael	CA	95608	(916) 371-5205
TAN, Hwee Ngaw	650 E Carson St.	Carson	CA	90745	(310) 518-4191
SOE, Thandar	29675 The Old Road	Castaic	CA	91384	(661) 702-6911
SOE, Thandar	29675 The Old Road	Castaic	CA	91384	(661) 702-6911
CHEN, Sam Wencan	20629 Redwood Road	Castro Valley	CA	94546	(510) 538-3088
CHEN, Sam Wencan	20629 Redwood Road	Castro Valley	CA	94546	(510) 538-3088
CHAROENSUK, Opat	21431 Devonshire St.	Chatsworth	CA	91311	(818) 341-0950
AYE, Thaw Zin	1366 East Ave	Chico	CA	95926	(530) 899-2320
VANG, Sou	720 Mangrove Street	Chico	CA	95926	(530) 895-6300
AYE, Thaw Zin	1366 East Ave	Chico	CA	95926	(530) 899-2320
KIM, Daniel Jun	659 E. Palomar St.	Chula Vista	CA	91911	(619) 397-0019
KIM, Joanne W	780 Otay Lakes Rd	Chula Vista	CA	91910	(619) 421-4822
CHO, Htin	5431 Clayton Rd	Clayton	CA	94517	(925) 672-2135
MIN, Khun Zayar	1650 Herndon Ave	Clovis	CA	93611	(559) 297-6410
MIN, Khun Zayar	1650 Herndon Ave	Clovis	CA	93611	(559) 297-6410
CHOI, Ungdo	2600 Willow Pass Rd	Concord	CA	94519	(925) 689-3240
MA, Qiling	4309 Clayton Road	Concord	CA	94521	(925) 356-2710
DENG, Xiaolong	12660 Limonite Ave	Corona	CA	92880	(951) 734-1087
LIAO, Chyong-Ing	2661 Green River Rd	Corona	CA	92882	(951) 371-4868
ZHAO, Yeying	137 Corte Madera Town Center	Corte Madera	CA	94925	(415) 927-1960
WINSWE, Hanmuyar	380 E. 17th Street	Costa Mesa	CA	92627	(949) 631-7357
WINSWE, Hanmuyar	380 E. 17th Street	Costa Mesa	CA	92627	(949) 631-7357
OO, Maung Saw	546 East Cotati Ave.	Cotati	CA	94931	(707) 795-9501
CHO, Aung	11030 Jefferson Blvd.	Culver City	CA	90230	(310) 398-1945
CHO, Aung	11030 Jefferson Blvd.	Culver City	CA	90230	(310) 398-1945
KANG, MyungHye	3827 Culver Ctr	Culver City	CA	90232	(310) 558-4027
KANG, MyungHye	3827 Culver Ctr	Culver City	CA	90232	(310) 558-4027
FELIX, Eka	10772 Jefferson Blvd	Culver City	CA	90230	(310) 839-4107
WIN, Nay Hlaing	20620 Homestead Road	Cupertino	CA	95014	(408) 253-0112
THEIN, Han	4033 Ball Rd.	Cypress	CA	90630	(714) 827-7947
AUNG, Swai Nandar	85 Westlake Mall	Daly City	CA	94015	(650) 755-0576
YI, Kyawt Wutt	24871 Del Prado	Dana Point	CA	92629	(949) 661-4145
MARAN, Ja Shan	3496 Camino Tassajara	Danville	CA	94506	(925) 736-0298
ZHANG, Jing	3496 Camino Tassajara	Danville	CA	94506	(925) 736-0298
XU, Hong Yan	1451 W. Covell Blvd	Davis	CA	95616	(530) 757-4540
KYAW, Shwe Zin	2121 Cowell Blvd.	Davis	CA	95618	(530) 792-8500
KAVIPIYA, Shin	815 Canyon Del Rey Blvd.	Del Rey Oaks	CA	93940	(831) 393-2090
MOO, Saw Lan Lar	1235 Stratford Ave	Dixon	CA	95620	(707) 678-7400
KIM, Un H.	9200 Lakewood Blvd	Downey	CA	90240	(562) 869-2042
LUO, Hui Yu	8626 Firestone Blvd	Downey	CA	90241	(562) 869-2733
YA, Zaw Thu	4440 Tassajara Road	Dublin	CA	94568	(925) 551-4710
PAIK, Chung Ja	7499 Dublin Blvd.	Dublin	CA	94568	(925) 556-4034
HLAWN, Ngun	11450 San Pablo Ave.	El Cerrito	CA	94530	(510) 233-8400
WUDOAN, Xiuzhen	11450 San Pablo Ave.	El Cerrito	CA	94530	(510) 233-8400
CHEN, De Quan	3383 Bass Lake Rd	El Dorado Hills	CA	95762	(530) 313-4920
MURAI, Misaki	2320 Mercury Ave. BLDG 251	El Segundo	CA	90245	(310) 414-9001
YI, Kristen Hee Jung	500 N Sepulveda Blvd	El Segundo	CA	90245	(310) 615-0537

Zenshi Food Service Counters

Franchise List

As of March 31, 2025

Franchisee Name	Address	City	State	Zip	Phone
THANG, Joseph	10050 Bruceville Rd	Elk Grove	CA	95757	(916) 479-7017
KYAW, Myo Myint	5021 Laguna Blvd.	Elk Grove	CA	95758	(916) 691-3770
THANG, Joseph	10050 Bruceville Rd	Elk Grove	CA	95757	(916) 479-7017
MO, Wei Lan	17840 Ventura Blvd.	Encino	CA	91316	(818) 345-6882
UK, Bual Zahre	2417 E Valley Pkwy	Escondido	CA	92027	(760) 740-0334
UK, Bual Zahre	2417 E Valley Pkwy	Escondido	CA	92027	(760) 740-0334
HONG, Yuri	8925 Madison Ave	Fair Oaks	CA	95628	(916) 965-1034
KHINE, Kathy	5450 Dewey Dr.	Fair Oaks	CA	95628	(916) 904-5356
ER, Zaang	2401 Waterman Drive	Fairfield	CA	94533	(707) 427-5640
ANDAYA, John Emerson	5051 Business Center Drive	Fairfield	CA	94534	(707) 863-4160
ER, Zaang	2401 Waterman Drive	Fairfield	CA	94533	(707) 427-5640
XIA, Lu	1850 Prairie City Road	Folsom	CA	95630	(916) 608-2450
AYE, Kyi Kyi	1850 Prairie City Road	Folsom	CA	95630	(916) 608-2450
PAN, Winny	16225 Sierra Lakes Pkwy	Fontana	CA	92336	(909) 357-1380
SONG, Min Soo	26751 Portola Pkwy	Foothill Ranch	CA	92610	(949) 457-9349
White, Maricruz	660 South Main St.	Fort Bragg	CA	95437	(707) 964-4079
ALBERTO, Walter Ramiro	701 S Fortuna Blvd	Fortuna	CA	95540	(707) 725-5104
ALBERTO, Walter Ramiro	701 S Fortuna Blvd	Fortuna	CA	95540	(707) 725-5104
ALBERTO, Walter Ramiro	701 S Fortuna Blvd	Fortuna	CA	95540	(707) 725-5104
TARANA, No Name Given	921 E. Hillsdale Boulevard	Foster City	CA	94404	(650) 377-0711
KIM, Jin Young	18405 Brookhurst St.	Fountain Valley	CA	92708	(714) 964-7566
BAILEY, Stephen Michael	2010 Freeddom Blvd	Freedom	CA	95019	(831) 728-2640
TUN, Myo Min	39100 Argonaut Way	Fremont	CA	94538	(510) 794-1666
CHANG, Hsien-Kuei	3902 Washington Blvd	Fremont	CA	94538	(510) 657-1625
MOE, Alice K.	46848 Mission Blvd.	Fremont	CA	94539	(510) 497-1003
SIN, Thant	5638 E Kings Canyon Rd.	Fresno	CA	93727	(559) 458-0209
ZHAO, Guanghao	3330 Yorba Linda Blvd	Fullerton	CA	92831	(818) 548-0584
LIN, Nathan	1121 N Harbor Blvd	Fullerton	CA	92832	(714) 992-2591
LWIN, Maung	12051 Euclid Ave	Garden Grove	CA	92840	(714) 636-6526
LWIN, Maung	12051 Euclid Ave	Garden Grove	CA	92840	(714) 636-6526
WIN, Si Thu	2201 W Redondo Beach Blvd	Gardena	CA	90247	(310) 538-9008
WIN, Si Thu	2201 W Redondo Beach Blvd	Gardena	CA	90247	(310) 538-9008
TUN, Aung Kyaw	905 First St.	Gilroy	CA	95020	(408) 842-6446
CHAE, Chang Hoon	1416 E Colorado St.	Glendale	CA	91205	(818) 548-0945
Khine, Thet Thet	1200 N. Central Ave.	Glendale	CA	91202	(818) 246-1752
CHAE, Chang Hoon	1416 E Colorado St.	Glendale	CA	91205	(818) 548-0945
WIN, John	5170 Hollister Ave	Goleta	CA	93111	(805) 692-0022
WIN, John	5170 Hollister Ave	Goleta	CA	93111	(805) 692-0022
NAING, Toe	18010 Chatsworth St.	Granada Hills	CA	91344	(818) 831-6556
LAZING, Lu San	867 Suttonway	Grass Valley	CA	95945	(530) 273-2249
MAUNG, Win Min	270 Bon Air Center	Greenbrae	CA	94904	(415) 461-1164
MAUNG, Win Min	270 Bon Air Center	Greenbrae	CA	94904	(415) 461-1164
PHYO, Pyae Sone	1758 W. Grand Ave.	Grover Beach	CA	93433	(805) 481-0877
NAING, Thein	16405 Highway 116	Guerneville	CA	95446	(707) 869-9433
SAN, REBECCA	11873 S. Hawthorne Blvd	Hawthorne	CA	90250	(310) 679-9164
WAI, Thiri	22280 Foothill Blvd	Hayward	CA	94541	(510) 582-0700
WAI, Thiri	22280 Foothill Blvd	Hayward	CA	94541	(510) 582-0700
AUNG, Nay Win	1345 Healdsburg Ave.	Healdsburg	CA	95448	(707) 433-7151
AUNG, Nay Win	1345 Healdsburg Ave.	Healdsburg	CA	95448	(707) 433-7151
NGEH, Eh	1115 Vine Street	Healdsburg	CA	95448	(707) 431-7102
NGEH, Eh	1115 Vine Street	Healdsburg	CA	95448	(707) 431-7102
KUN, Saw Be	715 Pier Ave.	Hermosa Beach	CA	90254	(310) 374-4484
OO, Ne Tun	591 Tres Pinos Road	Hollister	CA	95023	(831) 638-3240
SOE, Phyo Lin	5241 Warner Ave	Huntington Beach	CA	92649	(714) 377-0024
PARK, Il Min	19081 Goldenwest	Huntington Beach	CA	92648	(714) 960-8756
SAN, Thi Thi	49908 Jefferson Street	Indio	CA	92201	(760) 771-4373
SOE, Min	500 E Manchester Blvd	Inglewood	CA	90301	(310) 677-0286
LEE, Yeanyong	17605 Harvard Ave	Irvine	CA	92614-8544	(949) 851-3161
SONG, Chung Eu	5345 Alton Parkway	Irvine	CA	92604	(949) 552-0597
LAY, Tint Lei	14400 Culver Drive	Irvine	CA	92604	(649) 552-3065
KIM, Mi Sook	6300 Irvine Blvd	Irvine	CA	92620	(949) 559-1139
MAUNG, Lwin Maung	12110 Industry Blvd.	Jackson	CA	95642	(209) 257-0779
THU, Ar Kar Myo	7815 N. Lake Blvd.	Kings Beach	CA	96143	(530) 546-0170
LEE, Dong Gu	3233 Foothill Blvd	La Crescenta	CA	91214	(818) 658-1018
CHANG, Danny Yun Ping	2675 Foothill Blvd	La Crescenta	CA	91214	(818) 249-5448
LEE, Mike	1305 W Whittier Blvd.	La Habra	CA	90631	(714) 507-7602
LEE, Mike	1305 W Whittier Blvd.	La Habra	CA	90631	(714) 507-7602
LEE, Mike	1305 W Whittier Blvd.	La Habra	CA	90631	(714) 507-7602
LEE, Mike	1305 W Whittier Blvd.	La Habra	CA	90631	(714) 507-7602
LEE, Eunjin	8657 Villa La Jolla Drive	La Jolla	CA	92037	(858) 597-1550
KIM, Bok Soon	8011 University Ave	La Mesa	CA	91942	(619) 464-1011

Zenshi Food Service Counters

Franchise List

As of March 31, 2025

Franchisee Name	Address	City	State	Zip	Phone
OO, Yin Yin	1600 Foothill Blvd	La Verne	CA	91750	(909) 593-2572
MO, Aiqun	3540 Mt. Diablo Blvd.	Lafayette	CA	94549	(925) 283-0228
MOE, Sanda	700 S Coast Highway	Laguna Beach	CA	92651	(949) 497-6410
WANG, Yaping	25539 Paseo De Valencia	Laguna Hills	CA	92653	(949) 951-0966
WANG, Yaping	25539 Paseo De Valencia	Laguna Hills	CA	92653	(949) 951-0966
CHO, Jimmy	28231 Crown Valley Pkwy	Laguna Niguel	CA	92677	(949) 831-0767
Tan, Weiye	21751 Lake Forest Dr	Lake Forest	CA	92630	(949) 855-1242
Tan, Weiye	21751 Lake Forest Dr	Lake Forest	CA	92630	(949) 855-1242
RA, Zau	1071 11th Street	Lakeport	CA	95453	(707) 263-8072
LI, Zhi Fu	5951 Del Amo Blvd	Lakewood	CA	90713	(562) 867-7282
LI, Zhi Fu	5951 Del Amo Blvd	Lakewood	CA	90713	(562) 867-7282
KIM, Tae Wan	5500 Woodruff Ave.	Lakewood	CA	90713	(562) 866-3781
WIN, Maung Mya	BLDG 795 REEVES BLVD	LEMOORE	CA	93246	(559) 998-4669
CARLSON, Wai Mon	67 Lincoln Blvd	Lincoln	CA	95648	(916) 408-0800
LEW, Myint Kyi	4495 First St.	Livermore	CA	94551	(925) 455-2520
AUNG, Htin	2449 W Kettleman Lane	Lodi	CA	95242	(209) 367-7875
JIN, Jae A	6290 E. Pacific Cst Hwy	Long Beach	CA	90803	(562) 795-0167
XU, Xiuxiu	1930 Lakewood Blvd	Long Beach	CA	90815	(562) 494-4371
SHIN, Jung Min	2930 E 4th St.	Long Beach	CA	90814	(562) 434-3899
CHEN, Xiaoke	5949 E. Spring St.	Long Beach	CA	90808	(562) 496-2151
Sue, Nant	690 Fremont Ave	Los Altos	CA	94024	(650) 948-6648
PHI, Tha Ra	160 First Street	Los Altos	CA	94022	(650) 941-1801
MAW, Stephanie	2035 Hillhurst Ave	Los Angeles	CA	90027	(323) 660-0687
CHIA, Soon	944 E Slauson Ave.	Los Angeles	CA	90011	(323) 846-8804
CHIA, Soon	944 E Slauson Ave.	Los Angeles	CA	90011	(323) 846-8804
LINN, Saw Simon	670 S. Western Ave	Los Angeles	CA	90005	(213) 383-5058
KO, Ui Seok	645 West 9th Street	Los Angeles	CA	90015	(213) 452-0840
AUNG, Sithu	3410 W 3rd St.	Los Angeles	CA	90020	(213) 480-1421
THEIN, Win Papa	260 S. La Brea Ave	Los Angeles	CA	90036	(323) 937-3264
GO, Vonny L.	12057 Wilshire Blvd	Los Angeles	CA	90025	(310) 477-8746
YI, Eun San	21909 Ventura Blvd	Los Angeles	CA	91364	(818) 883-1907
MUALIMAH, Mualimah	7257 W Sunset Blvd	Los Angeles	CA	90046	(323) 512-8382
PARTINAH, Partinah	10309 W. Olympic Blvd.	Los Angeles	CA	90064	(310) 553-8117
SIN, Peggy Seung Yeo	5245 West Centinela Avenue	Los Angeles	CA	90045	(310) 641-2813
MUALIMAH, Mualimah	7257 W Sunset Blvd	Los Angeles	CA	90046	(323) 512-8382
TUN, Jefferson William	8825 S Sepulveda Blvd	Los Angeles	CA	90045	(310) 645-2035
YOO, Mina	11727 Olympic Blvd.	Los Angeles	CA	90064	(310) 473-5238
Oo, Aung Ni	1730 W Manchester Ave	Los Angeles	CA	90047	(323) 750-3151
YOON, Haejin	8701 Lincoln Blvd	Los Angeles	CA	90045	(310) 649-1526
LIN, Jiabin	5080 Rodeo Rd	Los Angeles	CA	90016	(323) 292-0633
AUNG, Zaw Myo	5601 Wilshire Blvd.	Los Angeles	CA	90036	(323) 936-4954
HE, Trinity Ying	4760 W Pico Blvd	Los Angeles	CA	90019	(323) 937-4107
ZAW, Wunna	2600 S. Vermont Ave.	Los Angeles	CA	90007	(323) 732-3863
CHANG, Se Ho	11361 National Blvd	Los Angeles	CA	90064	(310) 479-4351
AUNG, Zaw Myo	5601 Wilshire Blvd.	Los Angeles	CA	90036	(323) 936-4954
PARK, Il Soon	3461 W. Third Street	Los Angeles	CA	90020	(213) 384-6552
MAW, Stephanie	2035 Hillhurst Ave	Los Angeles	CA	90027	(323) 660-0687
SILWAL, Krishna Murari	15549 Union Ave.	Los Gatos	CA	95032	(408) 559-5750
SWE, Thein Thein	470 N. Santa Cruz Ave.	Los Gatos	CA	95030	(408) 354-9708
BLOI, Sanone	1240 Los Osos Valley Rd	Los Osos	CA	93402	(805) 528-0112
BLOI, Sanone	1240 Los Osos Valley Rd	Los Osos	CA	93402	(805) 528-0112
AWNG, Mary Lu	29211 Heather Cliff Drive	Malibu	CA	90265	(310) 457-2401
DONG, Ziyi	23841 W. Malibu Road	Malibu	CA	90265	(310) 456-2917
PARK, Byunghoon	2700 N Sepulveda Blvd	Manhattan Beach	CA	90266	(310) 546-2472
NAM, Kyung Mo	4700 Admiralty Way	Marina Del Rey	CA	90292	(310) 823-4684
KOH, Hyun Joo	4311 Lincoln Blvd.	Marina Del Rey	CA	90292	(310) 574-0909
TINT, Aye Aye	5034 Coakley Circle	Mariposa	CA	95338	(209) 742-6100
ALTANDUSH, Ariunchimeg	6688 Alhambra Ave	Martinez	CA	94553	(925) 933-0540
THEIN, Aye Mon Mon	Bldg 20850 Vandegrift Blvd	MCB Camp Pendleton	CA	92055	(760) 430-1701
SAN, Htike Htike	5507 Dudley Blvd.Bldg. 910	McClellan	CA	93723	(916) 925-8541
SAN, Htike Htike	5507 Dudley Blvd.Bldg. 910	McClellan	CA	93723	(916) 925-8541
BANTHAO, Pornphet Ricky	30125 Antelope Rd.	Menifee	CA	92584	(951) 679-2117
LIM, Alina Poe	525 El Camino Real	Menlo Park	CA	94025	(650) 847-2901
HUANG, Haiwei	525 El Camino Real	Menlo Park	CA	94025	(650) 847-2901
SHEIN, Khaing Zin	1 Camino Alto Drive	Mill Valley	CA	94941	(415) 388-6216
SHEIN, Khaing Zin	1 Camino Alto Drive	Mill Valley	CA	94941	(415) 388-6216
SEIN, Naw Aye	800 Redwood Hwy Frontage Rd #110	Mill Valley	CA	94941	(415) 360-9016
AUNG, Min	525 El Camino Real	Millbrae	CA	94030	(650) 652-3416
SHEN, Ping	551E. Calavares blvd.	Millpitas	CA	95035	(408) 262-9850
PHAN, Phuoc Hong	25104 Marguerite Parkway	Mission Viejo	CA	92692	(949) 830-3066
PHAN, Phuoc Hong	25104 Marguerite Parkway	Mission Viejo	CA	92692	(949) 830-3066

Zenshi Food Service Counters

Franchise List

As of March 31, 2025

Franchisee Name	Address	City	State	Zip	Phone
AUNG THU, Su Myat	2001 McHenry ave	Modesto	CA	95350	(209) 571-6280
PAN, Peiya	130 West Foothill Blvd	Monrovia	CA	91016	(626) 303-4547
COLOMA, John Walden	900 Lighthouse Ave	Monterey	CA	93940	(831) 718-2405
WAHYUNI, Sri	2230 South Atlantic Blvd.	Monterey Park	CA	91754	(323) 721-3367
LYU, Fang	330 North Atlantic Blvd.	Monterey Park	CA	91754	(626) 289-0261
KIM, Han Joo	1355 Moraga Way	Moraga	CA	94556	(925) 376-9492
CRUZ ZARATE, Ana Laura	840 East Dunne Ave.	Morgan Hill	CA	95037	(408) 776-8720
THANT, Win Min	235 Tennant Station	Morgan Hill	CA	95037	(408) 776-9861
SOE, Yan Naing	19555 South Mountain House Parkway	Mountain House	CA	95931	(209) 362-1256
SOE, Yan Naing	19555 South Mountain House Parkway	Mountain House	CA	95931	(209) 362-1256
MUN, Ban	570 N. Shoreline	Mountain View	CA	94043	(650) 961-4868
LANDAVERDE, Kemy Carmelina	1750 Miramonte	Mountain View	CA	94040	(650) 903-5850
KHAING, War War	645 San Antonio Road	Mountain View	CA	94040	(650) 948-4533
HLAING, KoKo	580 North Rengstorff Ave	Mountain View	CA	94043	(650) 316-6321
LIAN, Cung Thawng	23801 Washington Ave.	Murrieta	CA	92562	(951) 677-2297
KOKO, Hnin Nwe	3375 Jefferson Square	Napa	CA	94558	(707) 225-3037
AYE, Pa Pa	5877 Jarvis Ave.	Newark	CA	94560	(510) 713-3180
LWIN, Soe Myint	583 N Ventu Park Rd	Newbury Park	CA	91320	(805) 499-6743
LWIN, Soe Myint	583 N Ventu Park Rd	Newbury Park	CA	91320	(805) 499-6743
PARK, Jung Mi	2555 East Bluff Drive	Newport Beach	CA	92660	(949) 644-2060
CABREROS, Elvira	520 West Tefft St.	Nipomo	CA	93444	(805) 931-1850
HLAING, Aye Min Min	10900 Magnolia Blvd	North Hollywood	CA	91601	(818) 760-4148
HLAING, Aye Min Min	10900 Magnolia Blvd	North Hollywood	CA	91601	(818) 760-4148
GI, James	19781 Rinaldi St.	Northridge	CA	91326	(818) 832-5955
GI, James	19781 Rinaldi St.	Northridge	CA	91326	(818) 832-5955
HLAING, Maung Chit	900 Diablo Ave	Novato	CA	94947	(415) 898-1503
KYU, Pet Wah	5720 Nave Drive	Novato	CA	94949	(415) 881-9256
AUNG, Maung Aye Tun	40044 Highway 49	Oakhurst	CA	93644	(559) 642-4250
KOKO, Pye Phyo	6310 College Ave.	Oakland	CA	94618	(510) 985-0012
MAGAR, Shila	5100 Broadway	Oakland	CA	94611	(510) 658-6612
CI, John Lal	101 Old Grove Road	Oceanside	CA	92057	(760) 754-1035
CI, John Lal	101 Old Grove Road	Oceanside	CA	92057	(760) 754-1035
ZHANG, Tingrui	3075 S. Archibald Bldg	Ontario	CA	91761	(909) 947-1884
SUSANTO, Cathrine Cahya	2 CAMINO SOBRANTE	Orinda	CA	94563	(925) 254-8792
KIM, Jeoungdai	250 W. Esplanade Dr	Oxnard	CA	93036	(805) 288-8686
YEE, Bewin	1380 Linda Mar Blvd.	Pacifica	CA	94044	(650) 359-6707
YEE, Bewin	1380 Linda Mar Blvd.	Pacifica	CA	94044	(650) 359-6707
MU, San	12 Manor Plaza	Pacifica	CA	94044	(650) 359-2751
CHEN, Xiangxi	74884 Country Club Drive	Palm Desert	CA	92260	(760) 776-9821
HTOI, Hkawn	1733 E Palm Canyon Dr.	Palm Springs	CA	92264	(760) 325-5664
HTOI, Hkawn	1733 E Palm Canyon Dr.	Palm Springs	CA	92264	(760) 325-5664
GUO, Sai	164 S California Ave.	Palo Alto	CA	94306	(650) 323-8361
WIN, Aung Naing	3922 Middlefield Road	Palo Alto	CA	94303	(650) 494-1629
OO, Kristine	2811 Middlefield Road	Palo Alto	CA	94306	(650) 321-8400
LEE, Brandon Hyon	3601 E Foothill Blvd	Pasadena	CA	91107	(626) 351-8806
HTET, Myo	155 California Blvd	Pasadena	CA	91105	(626) 577-7149
PHYO, Zin Mimi	2355 East Colorado Blvd.	Pasadena	CA	91107	(626) 744-2615
MOH, Sabai Win	210 Western Ave.	Petaluma	CA	94952	(707) 762-5464
HAUSER, Richard	701 Sonoma Mountain Parkway	Petaluma	CA	94954	(707) 765-1198
AYE, May Saw	389 South McDowell Road	Petaluma	CA	94954	(707) 766-9097
TRAN, Jaclyn Mai	710 N Rose Dr.	Placentia	CA	92870	(714) 524-3984
LONE, Nai Saïke	3955 Missouri Flat Rd.	Placerville	CA	95667	(530) 295-2972
LONE, Nai Saïke	3955 Missouri Flat Rd.	Placerville	CA	95667	(530) 295-2972
OO, Win Mar	1978 Contra Costa Blvd.	Pleasant Hill	CA	94523	(925) 688-0680
OO, Win Mar	1978 Contra Costa Blvd.	Pleasant Hill	CA	94523	(925) 688-0680
HUANG, Shaona	707 Contra Costa Blvd.	Pleasant Hill	CA	94523	(925) 689-2044
NAING, Thuya H.	130 23rd Ave.	Port Hueneme	CA	93043	(805) 982-2400
NAING, Thuya H.	130 23rd Ave.	Port Hueneme	CA	93043	(805) 982-2400
Ramirez, Jesus Preciado	17539 Vierra Canyon Rd	Prunedale	CA	93907	(831) 663-6702
THAUNT, Saw Sha	10635 Folsom Blvd	Rancho Cordova	CA	95670	(916) 364-4940
JANG, Meme	10635 Folsom Blvd	Rancho Cordova	CA	95670	(916) 364-4940
MYINT, Kyi	7369 Miliken Ave	Rancho Cucamonga	CA	91730	(909) 944-4827
SU, Zhiling	12201 Highland Ave	Rancho Cucamonga	CA	91739	(909) 646-9356
LI, Yiyi	7243 Haven Ave	Rancho Cucamonga	CA	91701	(909) 944-4838
LI, Yiyi	7243 Haven Ave	Rancho Cucamonga	CA	91701	(909) 944-4838
CAO, Yang	8778 19th St.	Rancho Cucamonga	CA	91701	(909) 989-1000
TUN, Yarzar	30019 Hawthorne Blvd	Rancho Palos Verdes	CA	90275	(310) 377-6941
CUNG, Sang	1413 Hawthorne Blvd	Redondo Beach	CA	90278	(310) 370-9446
TUN, Myat Mon	1071 El Camino Real	Redwood City	CA	94063	(650) 306-1900
YE, Gang	15150 6th St.	Riverside	CA	92518	(951) 653-2206
LEE, James K	3350 LA Sierra Ave	Riverside	CA	92503	(951) 637-1948

Zenshi Food Service Counters

Franchise List

As of March 31, 2025

Franchisee Name	Address	City	State	Zip	Phone
GALAVIZ, Wendy	6155 Magnolia Ave	Riverside	CA	92506	(951) 274-9543
NGANG, Zin Lar	5225 Canyon Crest Dr	Riverside	CA	92507	(951) 784-3123
HE, Rong	2220 Sunset Blvd.	Rocklin	CA	95765	(916) 789-0101
KHINE, Kyaw Kyaw	8640 Sierra College Blvd.	Roseville	CA	95661	(916) 783-2225
PHAU RE, Doi La	8640 Sierra College Blvd.	Roseville	CA	95661	(916) 783-2225
LI, Zhuhui	1080 Pleasant Grove Blvd.	Roseville	CA	95678	(916) 783-2119
OO, Aung Aung	9045 Woodcreek Oaks Blvd.	Roseville	CA	95747	(916) 780-9919
MON, Wah Wah	1020 Johnson Ln	S. Lake Tahoe	CA	96150	(530) 542-7740
ZAW, Aung Zaw	8377 Elk Grove Florin Rd.	Sacramento	CA	95829	(916) 681-8666
SHWE, Myint	3320 Arden Way	Sacramento	CA	95825	(916) 483-9389
LWIN, Aye Aye	5345 Elkhorn Blvd	Sacramento	CA	95842	(916) 331-2987
SHWE, Myint	3320 Arden Way	Sacramento	CA	95825	(916) 483-9389
LEE, Jong Heon	2851 Del Paso Rd	Sacramento	CA	95835	(916) 285-8840
WIN, Kyaw Zin	1546 N Main St	Salinas	CA	93906	(831) 442-7500
NA, Hyeon Mi	1516 Constitution Blvd.	Salinas	CA	93905	(831) 444-3625
MUNOZ, Shuling Xue	838 Sir Francis Drake Bl	San Anselmo	CA	94960	(415) 456-9157
MUNOZ, Shuling Xue	838 Sir Francis Drake Bl	San Anselmo	CA	94960	(415) 456-9157
NAING, Thet	22 Bayhill Shopping Ctr.	San Bruno	CA	94066	(650) 873-8075
NAING, Thet	22 Bayhill Shopping Ctr.	San Bruno	CA	94066	(650) 873-8075
SAW, Joseph	903 S El Camino Real	San Clemente	CA	92672	(949) 361-8729
SAW, Joseph	903 S El Camino Real	San Clemente	CA	92672	(949) 361-8729
HTWE, Khin Cho	NAS North Island., Bldg 2017	San Diego	CA	92135	(619) 545-6560
KIM, Youngho	2525 Callagan Hwy.	San Diego	CA	92136	(619) 556-8657
WIN, Khin Mar	11875 Carmel Mountain Road	San Diego	CA	92128	(858) 451-8376
CHO, YONG JOON	1030 University Ave	San Diego	CA	92103	(619) 298-2931
KIM, Sung Soo	5680 Mission Center Rd.	San Diego	CA	92108	(619) 297-2593
ZI, Lidia Nguntha	10525 S Commons Drive	San Diego	CA	92127	(858) 675-0196
SOE, Myat Hnin	3011 Alta View Drive	San Diego	CA	92139	(619) 470-0574
KANG, Rachel Hyunsoon	3455 Del Mar Heights Rd	San Diego	CA	92130	(858) 259-1077
ZI, Si Tin	3345 Sports Arena Blvd	San Diego	CA	92110	(619) 222-0688
YOON, Young Sook	4315 Mission Blvd.	San Diego	CA	92109	(858) 273-0778
LIAN, Lal Ceu	1666 Rosecrans St.	San Diego	CA	92106	(619) 819-6040
SHING, Tang	6670 Montezuma Rd	San Diego	CA	92115	(619) 463-8893
LIM, Sumi	4627 Carmel Mountain Rd.	San Diego	CA	92130	(858) 523-1842
KANG, Young Goo	7788 Regents Road	San Diego	CA	92122	(858) 455-6130
LEE, Miran	5555 Balboa Ave.	San Diego	CA	92111	(858) 279-4661
MAWI, Lal Rem	3645 Midway Dr.	San Diego	CA	92110	(619) 222-6462
KANG, Young Goo	7788 Regents Road	San Diego	CA	92122	(858) 455-6130
KIM, Jin Seok	4145 30th Street	San Diego	CA	92104	(619) 284-6672
SHIN, Kyungmi	2495 Truxtun Rd	San Diego	CA	92106	(619) 758-1725
SEIN, Kyig Kyig	515 West Washington Street	San Diego	CA	92103	(619) 220-0195
MELTON, Michelle Lee	10016 Scripps Ranch Blvd.	San Diego	CA	92131	(858) 721-5350
MIN, Soe	448 Cortland Ave	San Francisco	CA	94110	(415) 648-3221
CHO, Daw Thi Thi	4201 18th Street	San Francisco	CA	94114	(415) 567-4902
THAN, Ma Myint Myint	635 Portola Drive	San Francisco	CA	94127	(415) 664-1600
MIN, Soe	448 Cortland Ave	San Francisco	CA	94110	(415) 648-3221
KYAW, Htin Lin	5290 Diamond Heights	San Francisco	CA	94131	(415) 824-7744
WIN, Htay	3350 Mission St	San Francisco	CA	94110	(415) 826-2866
LWIN, Htet OO	850 La Playa St.	San Francisco	CA	94121	(415) 387-4664
MYAT, Khine Su	730 Taraval Street	San Francisco	CA	94116	(415) 665-4136
WIN, Tin Cho	4950 Mission Street	San Francisco	CA	94112	(415) 587-7200
MA, Qixing	2350 Noriega Street	San Francisco	CA	94122	(415) 665-4565
HLA, Tin Tin	2020 Market St.	San Francisco	CA	94114	(415) 861-7660
OO, Myo T	15 Marina Blvd	San Francisco	CA	94123	(415) 563-4946
WIN, Zin Mar	298 King St.	San Francisco	CA	94107	(415) 633-1001
CHEN, Mei Chu	735 7th Ave	San Francisco	CA	94118	(415) 683-4070
WIN, Tin Cho	4950 Mission Street	San Francisco	CA	94112	(415) 587-7200
HTIN, Yuya	375 32nd Ave	San Francisco	CA	94121	(415) 683-4102
WU, Mee Mee	145 Jackson St.	San Francisco	CA	94111	(415) 982-3112
AYE, Ya Min	2435 California Street	San Francisco	CA	94115	(415) 567-4902
THET, Naing	179 Branham Lane	San Jose	CA	95136	(408) 227-4961
HTUN, Aye Aye Maw	6477 Almaden Express Way	San Jose	CA	95120	(408) 268-3511
HEIN, Maung	6150 BOLLINGER ROAD	San Jose	CA	95129	(408) 257-3070
LIN, Zin Phyu Phyu	1663 Branham Lane	San Jose	CA	95118	(408) 267-0550
KIE, Lina	5146 Stevens Creek Blvd.	San Jose	CA	95129	(408) 556-0610
MUN, Zaw	1300 W. San Carlos	San Jose	CA	95126	(408) 882-0999
WIN, Zar Ni	1530 Hamilton Ave.	San Jose	CA	95125	(408) 264-1523
DENG, Xiao Bao	4950 Almeden Expressway	San Jose	CA	95118	(408) 267-1200
WIN, Zar Ni	1530 Hamilton Ave.	San Jose	CA	95125	(408) 264-1523
THWE, Yoon Thiri Kay	1455 Berryessa Rd	San Jose	CA	95133	(408) 272-2287
NAUNG, Naung	5760 Cottle Road	San Jose	CA	95123	(408) 362-9255

Zenshi Food Service Counters

Franchise List

As of March 31, 2025

Franchisee Name	Address	City	State	Zip	Phone
SHAO, Tie	1305 Winchester Blvd	San Jose	CA	95117	(408) 374-2954
SONE, Pye	2980 E. Capitol Expressway	San Jose	CA	95148	(408) 274-5957
KANG, Hunsuk	306 Twin Oaks Valley Road	San Marcos	CA	92078	(760) 891-0607
AUNG, Phyo Ei	100 De Anza Blvd	San Mateo	CA	94402	(650) 341-4039
MYO, Myo	1655 El Camino Real	San Mateo	CA	94402	(650) 341-0374
HTUT, Zinmin	155 Marinwood Ave	San Rafael	CA	94903	(415) 491-1965
Wong Dan, Melinda Arlette	950 Las Gallinas Ave	San Rafael	CA	94903	(415) 479-6111
KO, Aye Ko	2505 San Ramon Valley	San Ramon	CA	94583	(925) 831-9515
HLA, Bhone	11050 Bollinger Canyon Rd.	San Ramon	CA	94582	(925) 359-2001
HUANG, Allen Shu-Xian	11050 Bollinger Canyon Road	San Ramon	CA	94582	(925) 359-2001
TUN, Nay	2760 Homestead Rd	Santa Clara	CA	95051	(408) 248-0563
CHAN, Davey Soe	2605 The Alameda	Santa Clara	CA	95050	(408) 244-6873
TUN, Nay	2760 Homestead Rd	Santa Clara	CA	95051	(408) 248-0563
LI, Brang	3970 Rivermark Plaza	Santa Clara	CA	95054	(408) 855-0980
GURBAZAR, Bolortuya	1644 Cloverfield Blvd	Santa Monica	CA	90404	(310) 582-3900
LEI, Shao Rong	560 Montecito Blvd	Santa Rosa	CA	95409	(707) 537-7123
MOH, Thon Hin	461 Stony Point Road	Santa Rosa	CA	95401	(707) 284-3530
HTAY, Maung Myint	100 Calistoga Rd	Santa Rosa	CA	95409	(707) 539-1711
KHIN, Su Su	2785 Yulupa Ave.	Santa Rosa	CA	95405	(707) 524-4646
SEIN, Chuck Myo	2751 Fourth Street.	Santa Rosa	CA	95405	(707) 522-1455
HTAY, Maung Myint	100 Calistoga Rd	Santa Rosa	CA	95409	(707) 539-1711
HTAY, Khin Maung	1211 W. College Ave	Santa Rosa	CA	95401	(707) 546-6877
CHEN, Xiangwu	1211 W. College Ave	Santa Rosa	CA	95401	(707) 546-6877
GUO, Yanyuan	12876 Saratoga Sunnyvale Rd	Saratoga	CA	95070	(408) 867-0180
THU, Wai Min	100 Harbor Dr.	Sausalito	CA	94965	(415) 331-6900
HTWE, Yin Thwe Thwe	253 Mount Hermon Road	Scotts Valley	CA	95066	(831) 438-7431
YIN, Zhesheng	12470 Seal Beach Blvd.	Seal Beach	CA	90740	(562) 598-3128
KANG, Young Em	4240 Gigling Rd.	Seaside	CA	93955	(831) 242-7668
YAW, Htoi	406 North Main St.	Sebastopol	CA	95472	(707) 823-1101
KYI, Marcus Chit	14049 Ventura Blvd	Sherman Oaks	CA	91423	(747) 233-6100
SANG, Esther	14440 Burbank Blvd	Sherman Oaks	CA	91401	(818) 989-5640
AUNG, Tin Htun	2726 E Los Angeles Ave	Simi Valley	CA	93065	(805) 527-1122
AUNG, Tin Htun	2726 E Los Angeles Ave	Simi Valley	CA	93065	(805) 527-1122
LEE, Sukwan	931 Lomas Santa Fe Dr.	Solana Beach	CA	92075	(858) 481-1008
TUN, Zin Sabai	1291 Sanguinetti Road	Sonora	CA	95370	(209) 533-7810
AYE, Myo	2720 41st Ave.	Soquel	CA	95073	(831) 477-7212
LWIN, San	1745 Garfield Ave	South Pasadena	CA	91030	(626) 799-5790
LWIN, San	1745 Garfield Ave	South Pasadena	CA	91030	(626) 799-5790
KYI, Thidar	2255 Gellert Blvd	South San Francisco	CA	94080	(650) 588-9005
WIN, Htwe	2808 Country Club Blvd.	Stockton	CA	95204	(209) 461-5555
OO, Yi Yi	6445 North Pacific Ave.	Stockton	CA	95207	(209) 472-8600
HAN, Ki C	12842 Ventura Blvd	Studio City	CA	91604	(818) 761-6196
SENHRANG, Phunhremang	8325 Laurel Canyon Blvd	Sun Valley	CA	91352	(818) 768-0378
SENHRANG, Phunhremang	8325 Laurel Canyon Blvd	Sun Valley	CA	91352	(818) 768-0378
LIN, Mao Shu	10455 Sunland Blvd	Sunland	CA	91040	(818) 352-4544
KO, Htet Myat	639 S. Bernardo Ave.	Sunnyvale	CA	94087	(408) 732-5900
YAO, Gang	785 E. El Camino Real	Sunnyvale	CA	94087	(408) 481-3300
AYE, Thin Thin	150 E. El Camino Real	Sunnyvale	CA	94087	(408) 732-1259
SETIAWAN, Andri	1356 S Mary Ave	Sunnyvale	CA	94087	(408) 212-4928
QI, Qinfeng	33145 Temecula Parkway	Temecula	CA	92592	(951) 303-3102
KYI, Tin Thidar	9470 Las Tunas Dr.	Temple City	CA	91780	(626) 286-8125
KYI, Tin Thidar	9470 Las Tunas Dr.	Temple City	CA	91780	(626) 286-8125
CHAE, Min Chul	3963 E. Thousand Oaks Blvd.	Thousand Oaks	CA	91362	(805) 496-2469
CHOI, Jeong A	1500 N Moorpark Rd.	Thousand Oaks	CA	91360	(805) 379-3100
CHAE, Min Chul	3963 E. Thousand Oaks Blvd.	Thousand Oaks	CA	91362	(805) 496-2469
CAMACHO CARREON, Javier	5035 Pacific Coast Hwy	Torrance	CA	90505	(310) 378-0295
LEE, Hyungkyu	3455 Sepulveda Blvd	Torrance	CA	90505	(310) 542-1639
RUNG, Mang	2909 Rolling Hills Rd	Torrance	CA	90505	(310) 325-0611
LWIN, Ko Ko	460 Skymaster Dr.	Travis AFB	CA	94535	(707) 437-4004
TAN, Thein	11290 Donner Pass Rd	Truckee	CA	96161	(530) 582-7950
MYAT, May Thet	3051 Countryside Drive	Turlock	CA	95380	(209) 669-2725
KIM, Yoo Rok	13321 Jamboree Road	Tustin	CA	92782	(714) 544-0491
LWIN, May Thu	Twentynine Palms MCAGG	Twentynine Palms	CA	92278	(760) 830-7572
WEIGHTMAN, Matthew Charles	653 South State St.	Ukiah	CA	95482	(707) 467-2700
KYAW, Aung Myo	1790 Decoto Rd	Union City	CA	94587	(510) 429-9090
WEI, Li	81 W. Foothill Blvd	Upland	CA	91786	(909) 981-7709
LI, John Wen	2090 Harbison Drive	Vacaville	CA	95687	(707) 452-7277
MOE, Soe	27760 N McBean Pkwy	Valencia	CA	91354	(661) 263-7690
MOE, Soe	27760 N McBean Pkwy	Valencia	CA	91354	(661) 263-7690
DEE, Saw Pit	7221 Woodman Ave	Van Nuys	CA	91405	(818) 785-3162
AUNG, Pyae Hein	12921 Magnolia Blvd	Van Nuys	CA	91423	(818) 986-2293

Zenshi Food Service Counters

Franchise List

As of March 31, 2025

Franchisee Name	Address	City	State	Zip	Phone
DEE, Saw Pit	7221 Woodman Ave	Van Nuys	CA	91405	(818) 785-3162
KYWE, Kaung	17250 Saticoy St.	Van Nuys	CA	91406	(818) 609-8425
KYI, Moe Moe Min	135 Wyoming Ave	Vandenberg AFB	CA	93437	(805) 734-3354
LIEM, Lena	910 Lincoln Blvd	Venice	CA	90291	(310) 392-4854
TUN, Tin Myat	1776 Victoria Avenue	Ventura	CA	93003	(805) 650-0239
TUN, Tin Myat	1776 Victoria Avenue	Ventura	CA	93003	(805) 650-0239
NGUYEN, Quan Thoi	17801 Santiago Blvd.	Villa Park	CA	92861	(714) 998-0004
WIN, Maung San	710 Bancroft Rd.	Walnut Creek	CA	94598	(925) 937-8537
PE, Sai Nyi Nyi	12138 Yosemite Blvd	Waterford	CA	95386	(209) 874-9751
YI, Kwang San	22915 Victory Blvd.	West Hills	CA	91307	(818) 716-8199
CHAE, Jeong A An	9040 W. Beverly Blvd.	West Hollywood	CA	90048	(310) 278-1351
XIONG, Gang	14919 Whittier Blvd	Whittier	CA	90605	(562) 945-3779
XIONG, Gang	14919 Whittier Blvd	Whittier	CA	90605	(562) 945-3779
MOE, Kyaw Thet	845 South Main Street	Willits	CA	95490	(707) 459-5862
THU, Aung	9230 Old Redwood Hwy	Windsor	CA	95492	(707) 687-2050
THU, Aung	9230 Old Redwood Hwy	Windsor	CA	95492	(707) 687-2050
KHADKA RAUT, Sita	365 North Telluride	Aurora	CO	80011	(720) 847-5613
KOIRALA, Hareram	1200 S. Buckley Road	Aurora	CO	80017	(303) 750-6802
ZING, Hlawn Nei	3325 28th Street	Boulder	CO	80301	(303) 938-1271
THANG, David Run Ceu	2798 Arapahoe Ave	Boulder	CO	80302	(303) 443-5888
THANG, David Run Ceu	2798 Arapahoe Ave	Boulder	CO	80302	(303) 443-5888
VANG, Esther Tuan Cer	3602 W 144th Ave	Broomfield	CO	80020	(303) 209-2405
THANG, Tin	880 S. Perry Street	Castle Rock	CO	80104	(303) 688-5028
OH, Hyun Sook	7375 E Arapahoe Road	Centennial	CO	80112	(303) 771-8707
OH, Hyun Sook	7375 E Arapahoe Road	Centennial	CO	80112	(303) 771-8707
BIK, Van Tha	7055 Austin Bluffs Parkway	Colorado Springs	CO	80923	(719) 264-8650
BIK, Van Tha	7055 Austin Bluffs Parkway	Colorado Springs	CO	80923	(719) 264-8650
BIK, Van Tha	7055 Austin Bluffs Parkway	Colorado Springs	CO	80923	(719) 264-8650
PIANG, Cing Lam	1121 N. Circle Drive	Colorado Springs	CO	80909	(719) 573-6023
KAP, Do Lian	6520 S. Academy Blvd	Colorado Springs	CO	80906	(719) 527-4807
KAP, Do Lian	6520 S. Academy Blvd	Colorado Springs	CO	80906	(719) 527-4807
ZAW, Jessica Khine	1920 South Nevada Ave	Colorado Springs	CO	80905	(719) 636-5255
ZAW, Jessica Khine	1920 South Nevada Ave	Colorado Springs	CO	80905	(719) 636-5255
CIN, Nun Ceu	27152 Main Street	Conifer	CO	80433	(303) 838-4375
THANG, Biak Cin	200 Quebec Street	Denver	CO	80230	(303) 340-4455
LIN, Naing	3840 E. 104th Ave.	Denver	CO	80233	(303) 255-0596
HUNG, David	3800 W. 44th Ave	Denver	CO	80211	(303) 458-8418
KIM, Eunsook	323 South Broadway	Denver	CO	80209	(303) 744-8531
KIM, Eunsook	323 South Broadway	Denver	CO	80209	(303) 744-8531
CUNG, Biak Tha	2660 N. Federal Blvd	Denver	CO	80211	(303) 477-5091
BK, Prabha	6460 E Yale Ave	Denver	CO	80222	(303) 691-8870
BK, Prabha	6460 E Yale Ave	Denver	CO	80222	(303) 691-8870
KIM, Uichan	2150 S. Downing St.	Denver	CO	80210	(303) 722-6117
THANG, Biak Cin	200 Quebec Street	Denver	CO	80230	(303) 340-4455
LIN, Naing	3840 E. 104th Ave.	Denver	CO	80233	(303) 255-0596
KIM, Uichan	2150 S. Downing St.	Denver	CO	80210	(303) 722-6117
MYINT, Thein Htay	6220 E 14th Ave	Denver	CO	80220	(303) 242-3526
PANDITA, FNU	311 W. College Dr	Durango	CO	81301	(970) 382-2224
ENG, Lal	220 South Elizabeth Street	Elizabeth	CO	80107	(303) 646-0336
KIM, Seoghwan	3333 Arapahoe Road	Erie	CO	80516	(720) 890-0959
KIM, Seoghwan	3333 Arapahoe Road	Erie	CO	80516	(720) 890-0959
TUN, Zaw Zaw	451 E Wonderview Ave	Estes Park	CO	80517	(970) 586-4447
TUN, Zaw Zaw	451 E Wonderview Ave	Estes Park	CO	80517	(970) 586-4447
HUP, Lai	3851 S. Highway #74	Evergreen	CO	80439	(303) 674-6625
SHEN, Chunhua	1551 Prussman Blvd	Fort Carson	CO	80913	(719) 526-5811
CAJUMBAN, Errol King De	6925 Mesa Ridge Parkway	Fountain	CO	80817	(719) 322-9351
NUNG, Mang Cung	40 County Road 804	Fraser	CO	80442	(970) 726-9484
MOE, Yu Myat	3660 S. Mason Street	Ft. Collins	CO	80525	(970) 223-3221
MOE, Yu Myat	3660 S. Mason Street	Ft. Collins	CO	80525	(970) 223-3221
MOE, Yu Myat	3660 S. Mason Street	Ft. Collins	CO	80525	(970) 223-3221
BIK, Zaw	1701 Jackson Street	Golden	CO	80401	(303) 278-1861
BIK, Zaw	1701 Jackson Street	Golden	CO	80401	(303) 278-1861
CEU, Tawk Hlei	2512 Broadway	Grand Junction	CO	81057	(970) 257-0072
NAWL, Zion Za	2901 F Road	Grand Junction	CO	81504	(970) 248-9869
CEU, Tawk Hlei	2512 Broadway	Grand Junction	CO	81057	(970) 257-0072
TUN, Ko Ko	8434 South Kipling Parkway	Littleton	CO	80127	(720) 922-0305
PARK, Kyoung Sook	9255 S Broadway	Littleton	CO	80129	(303) 683-6895
PARK, Kyoung Sook	9255 S Broadway	Littleton	CO	80129	(303) 683-6895
TUN, Ko Ko	8434 South Kipling Parkway	Littleton	CO	80127	(720) 922-0305
HTAY, Aung	181 W. Mineral Avenue	Littleton	CO	80120	(303) 218-2100
LIAN, Ro	1050 Ken Pratt Blvd	Longmont	CO	80501	(303) 651-7952

Zenshi Food Service Counters

Franchise List

As of March 31, 2025

Franchisee Name	Address	City	State	Zip	Phone
LIAN, Ro	1050 Ken Pratt Blvd	Longmont	CO	80501	(303) 651-7952
THANG, Biak	2321 W. Eisenhower Blvd.	Loveland	CO	80537	(970) 669-1342
THANG, Biak	2321 W. Eisenhower Blvd.	Loveland	CO	80537	(970) 669-1342
CUNG, Dawt Za	624 Highway 105	Monument	CO	80132	(719) 488-1187
CUNG, Dawt Za	624 Highway 105	Monument	CO	80132	(719) 488-1187
MAUNG, Khan	1040 East Stewart Avenue	Peterson AFB	CO	80914	(719) 556-7765
MAUNG, Khan	1040 East Stewart Avenue	Peterson AFB	CO	80914	(719) 556-7765
SUNG, Thluai	1601 West Us Highway 50 # 1	Pueblo	CO	81008	(719) 543-5921
KHUP, Pau Khen	1017 N. Market Plaza	Pueblo	CO	81007	(719) 547-2108
BIK, Bawi Siang	37500 E. US Highway 40	Steamboat Springs	CO	80487	(970) 879-3766
CUNG, Ai	1601 Coalton Road	Superior	CO	80027	(303) 543-1153
CUNG, Ai	1601 Coalton Road	Superior	CO	80027	(303) 543-1153
AUNG, Nay Lin	255 W Main Street	Avon	CT	6001	(860) 678-1322
AUNG, Nay Lin	255 W Main Street	Avon	CT	6001	(860) 678-1322
KHAING, Zaw Min	83 Stony Hill Road	Bethel	CT	6801	(203) 791-8589
SAI, Sai Sheing	1060 west Main Street	Branford	CT	6405	(203) 481-9671
PALOMINOS ESPINOZA, Ivan Alexis	14 Candlewood Lake Road	Brookfield	CT	6804	(800) 828-2688
ZHANG, Jiwen	1021 South Main Street	Cheshire	CT	6410	(203) 272-2266
ZHANG, Jiwen	1021 South Main Street	Cheshire	CT	6410	(203) 272-2266
DOLMA, Chozo	23 Killingworth Turnpike	Clinton	CT	6413	(860) 664-8043
LIAN, Thomas Zo	70 Wauregan Road	Danielson	CT	6239	(860) 779-7223
JIANG, Wu	656 New Haven Ave	Derby	CT	6418	(203) 734-9283
LATT, Myo Minn	135 West Road	Ellington	CT	6029	(860) 896-0457
DOH, Ktaw	65 Palomba Drive	Enfield	CT	6082	(860) 749-5514
DOH, Ktaw	65 Palomba Drive	Enfield	CT	6082	(860) 749-5514
CHEN, Wen An	995 Poquonnock Road	Groton	CT	6340	(860) 449-1229
PHONE, Paul	Bldg 484 Sub Base	Groton	CT	6349	(860) 694-2244
PHYU, Lei Win	830 Boston Post Road	Guilford	CT	6437	(203) 453-3267
THEIN, Mai Khun	234 Tolland Turnpike	Manchester	CT	6042	(860) 645-7140
THARCHIN, Tsewang	141 B Storrs Road	Mansfield	CT	6250	(860) 456-8051
QUAN, Jingnan	7 East Hampton Road	Marlborough	CT	6447	(860) 467-9136
TUN, Thet	533 South Broad Street	Meriden	CT	6450	(203) 237-5244
TUN, Thet	533 South Broad Street	Meriden	CT	6450	(203) 237-5244
TUN, Thet	533 South Broad Street	Meriden	CT	6450	(203) 237-5244
KHIN, Yee Yee	850 S. Main St.	Middletown	CT	6457	(860) 807-4265
Ha, Kyaw Thi	150 Boston Post Road	Milford	CT	6460	(203) 453-3267
THEINT, Su Hnin	535 Monroe Tpke	Monroe	CT	6468	(203) 452-9002
THEINT, Su Hnin	535 Monroe Tpke	Monroe	CT	6468	(203) 452-9002
DOLMA, Tsepa	79 Stonington Road	Mystic	CT	6355	(860) 536-5813
TSOMO, Dawa	1289 Foxon Road	N Branford	CT	6471	(203) 488-4953
AYE, Tun	85 Bridge Street	Naugatuck	CT	6770	(203) 729-4124
LWIN, Kyaw	1 Kent Road	New Milford	CT	6776	(860) 355-2628
JAMPA, Phuntsok	224 Salem Turnpike	Norwich	CT	6360	(860) 886-9996
YAWONGTSANG, Tenzin	90 Halls Road	Old Lyme	CT	6371	(860) 434-1433
TUN, Tin Shwe	28 Spencer Plain Road	Old Saybrook	CT	6475	(413) 504-6058
JINPA, Lobsang	83 Lathrop Road	Plainfield	CT	6374	(860) 564-1888
WANGDU, Michael	275 New Britain Ave	Plainville	CT	6062	(860) 747-5724
ZIN, Saw Ba Oo Gyi	1040 Elm Street	Rocky Hill	CT	6067	(413) 504-6044
LIN, WAI Y	87 W Stafford Road RT. 190	Stafford Springs	CT	6076	(860) 684-5029
SOE, Hein Zaw	355 Hawley Lane	Stratford	CT	6614	(203) 386-0576
SOE, Hein Zaw	355 Hawley Lane	Stratford	CT	6614	(203) 386-0576
ZEREN, Silang	33 Fieldstone Commons	Tolland	CT	6084	(860) 872-0304
KYAW, Thura	504 Winsted Road	Torrington	CT	6790	(860) 489-0246
WANG, Xiu Ming	772 N. Main St	West Hartford	CT	6117	(860) 236-1505
KODA, Zachery	185 Chappie James Blvd.	Boiling AFB	DC	20032	(202) 767-4695
AUNG, Nhaine Htet	268 Galaxy Street	Dover AFB	DE	19902	(302) 677-3919
THANG, Hrang Tin	31221 Americana Pkwy.	Selbyville	DE	19975	(302) 436-2827
THANG, Hrang Tin	31221 Americana Pkwy.	Selbyville	DE	19975	(302) 436-2827
KIM, Ngin Khat	7655 STADIUM PKWY	MELBOURNE	FL	32940	(321) 426-2915
BO, Thidar	16193 N W US Hwy 441	Alachua County	FL	32615	(386) 418-3435
KIM, Young C.	851 S State Road 434	Altamonte Springs	FL	32714	(407) 522-1100
ZAW, Han Lin	482 E. Altamonte Dr.	Altamonte Springs	FL	32701	(407) 260-9973
MUNG, Kim Hau Tawi	503 E Altamonte Drive	Altamonte Springs	FL	32701	(321) 207-7128
MAWI, Run Siang	6434 N Us Highway 41	Apollo Beach	FL	33572-1804	(813) 649-1280
CUANG, Van Nei	5052 N Highway 41	Apollo Beach	FL	33572	(813) 641-2377
CUANG, Van Nei	5052 N Highway 41	Apollo Beach	FL	33572	(813) 641-2377
CING, Ning Ngaih Khawm	540 S. Hunt Club Blvd	Apopka	FL	32703	(407) 862-5255
THANG, Pau En	1545 Rock Springs Rd.	Apopka	FL	32712	(407) 880-4040
CING, Ning Ngaih Khawm	540 S. Hunt Club Blvd	Apopka	FL	32703	(407) 862-5255
LIANSANG, Khamsawm	3080 W. KELLY PARK RD.	Apopka-Orange	FL	32712	(407) 464-0804
MUNG, Lian	2551 SE Highway 70	Arcadia	FL	34266	(863) 494-0999

Zenshi Food Service Counters

Franchise List

As of March 31, 2025

Franchisee Name	Address	City	State	Zip	Phone
THANG, Mary Cing Deih	2294 Mayport Rd #51 Bldg.	Atlantic beach	FL	32233	(904) 249-7524
THANG, Mary Cing Deih	2294 Mayport Rd #51 Bldg.	Atlantic beach	FL	32233	(904) 249-7524
HERRERA, Aleida Ingrid	4975 Avila Ave	Ave Maria	FL	34142	(239) 304-3269
KAP, Pau Lian	2952 Aventura Blvd	Aventura-Dade	FL	33180	(305) 792-1429
THONGSA, Suphachai	255 East Van Fleet Drive	Bartow	FL	33830	(863) 534-1560
THANG, Cin Suan	10301 SE US Highway 441	Belleview	FL	34420	(352) 245-4115
THANG, Cin Suan	10301 SE US Highway 441	Belleview	FL	34420	(352) 245-4115
CHAI, Bee Lan	9720 Clint Moore Rd.	Boca Raton	FL	33496	(561) 218-6114
THANG, Hau Thawn	22973 State Rd 7 South	Boca Raton	FL	33428	(561) 488-5994
WIN, Sandar	7431 N. Federal Hwy	Boca Raton	FL	33487	(561) 241-9700
CHAI, Bee Lan	9720 Clint Moore Rd.	Boca Raton	FL	33496	(561) 218-6114
NGE, Maung	3003 Yamato Rd. Suite C9	Boca Raton	FL	33434	(561) 241-5005
PI, Nang	1339 W. Palmetto Park Rd.	Boca Raton	FL	33486	(561) 362-5305
MANG, Cing Kham	1001 South Federal Highway	Boca Raton	FL	33432	(561) 417-2445
LIAN, Thang Ngaih	11650 W. Palmetto Park Rd	Boca Raton	FL	33428	(561) 470-9370
ZAW, Khin	4141 N. Federal Hwy	Boca Raton	FL	33431	(561) 361-0529
ZAW, Khin	4141 N. Federal Hwy	Boca Raton	FL	33431	(561) 361-0529
THITE, Saw Min	21230 St. Andrews Blvd.	Boca Raton	FL	33433	(561) 544-2422
THANG, Hau Thawn	22973 State Rd 7 South	Boca Raton	FL	33428	(561) 488-5994
OO, Kyaw Zan	1968 NE Fifth Ave	Boca Raton	FL	33431	(561) 750-9476
LIAN, Khup Vang	8210 Glades Rd	Boca Raton	FL	33434	(561) 852-8172
KHUP, Gin Lam	5050 Champion Blvd	Boca Raton	FL	33496	(561) 981-5390
LIAN, Khup Vang	8210 Glades Rd	Boca Raton	FL	33434	(561) 852-8172
SOE, Myat Zay Yar	12900 Trade Way Four	Bonita Springs	FL	34135	(239) 992-7508
YANG, Xiaoqiao	3304 Bonita Beach Road	Bonita Springs	FL	34134	(239) 495-1600
SI, Aung	26841 Tamiami Trail	Bonita Springs	FL	34134	(239) 992-0105
PLEASANTS, MONTY	6627 W. Boynton Beach Blvd	Boynton Beach	FL	33437	(561) 731-2065
KHAI, Thang Khan	8340 Jog Rd	Boynton Beach	FL	33437	(561) 734-6252
TUN, Saw Win	1005 Gateway Blvd	Boynton Beach	FL	33426	(561) 732-6148
HTIKE, Htike Aung	12425 Hagen Ranch Rd.	Boynton Beach	FL	33437	(561) 292-4489
LIAN, Pau Suan	10935 Jog Road	Boynton Beach	FL	33437	(561) 734-6252
TUN, Saw Win	1005 Gateway Blvd	Boynton Beach	FL	33426	(561) 732-6148
KHAI, Thang Lian	4770 N Congress Ave	Boynton Beach	FL	33426	(561) 868-5530
LIN, Zam Go	133 N Congress Ave	Boynton Beach	FL	33426	(561) 364-3707
KHAM, Hau Cin	4966 Le Chalet Blvd	Boynton Beach	FL	33436-1406	(561) 369-3500
AYE, Nilar	7290 55th Ave. E	Bradenton	FL	34203	(941) 727-8808
SUI, Tha Nei	5001 E State Rd. 64	Bradenton	FL	34208	(941) 744-0866
CHEN, ChinDeng	3913 Manatee Ave W.	Bradenton	FL	34205	(941) 746-1660
KHUP, Gin Suan	1755 Lakewood Ranch Blvd	Bradenton	FL	34211	(941) 745-5677
AYE, Nilar	7290 55th Ave. E	Bradenton	FL	34203	(941) 727-8808
THANG, Bawi Min	7310 Manatee Ave W	Bradenton	FL	34209	(941) 792-1213
AYE, Nilar	7290 55th Ave. E	Bradenton	FL	34203	(941) 727-8808
MUNG, Dai Kham	4651 Cortez Rd. West	Bradenton	FL	34210	(941) 792-7195
KIM, Cung Rem	14605 SR 70	Bradenton	FL	34202	(941) 751-1325
AYE, Nilar	7290 55th Ave. E	Bradenton	FL	34203	(941) 727-8808
ONG, Nai C	939 W Brandon Blvd	Brandon	FL	33511	(813) 684-6562
SANG, Hnin	11255 Causeway Blvd.	Brandon	FL	33511	(813) 655-8911
BAH, Zaw	949 E Bloomingdale Ave	Brandon	FL	33511	(813) 654-2598
LIAN, Van Sui	19390 Cortez Blvd.	Brooksville	FL	34601-3041	(352) 796-2926
THEIN, Hla	1616 Cape Coral Pkwy W # 5	Cape Coral	FL	33914	(239) 945-6222
SANG KUNG, Om Thang	100 Hancock Bridge Pkwy W.	Cape Coral	FL	33991	(239) 458-8900
PAWLSUK, Michael	1631 del Prado Blvd S	Cape Coral	FL	33990	(239) 772-3332
OO, Aung Zin	2420 Santa Barbara Blvd	Cape Coral	FL	33914	(239) 574-6395
PHOO, Khine Thazin	3015 S.W. Pine Island Rd.	Cape Coral	FL	33991	(239) 282-5515
PAWLSUK, Michael	1631 del Prado Blvd S	Cape Coral	FL	33990	(239) 772-3332
OO, Aung Zin	2420 Santa Barbara Blvd	Cape Coral	FL	33914	(239) 574-6395
PIANG, Thang San	1735 NE Pine Island Rd.	Cape Coral	FL	33909	(239) 573-0818
PHOO, Khine Thazin	3015 S.W. Pine Island Rd.	Cape Coral	FL	33991	(239) 282-5515
WIN, Ma Kyi Kyi	3385 S US Highway 17/92 Suite 181	Casselberry	FL	32707	(407) 831-2020
WIN, Ma Kyi Kyi	3385 S US Highway 17/92 Suite 181	Casselberry	FL	32707	(407) 831-2020
KEUH, Thang	1520 N. McMullen Booth Rd.	Clearwater	FL	33759	(727) 725-4900
HRE, Jonathan Tin	1555 S Highland Ave	Clearwater	FL	33756	(727) 442-5511
MANG, Ngun Hre	619 South Ft. Harrison Ave.	Clearwater	FL	33756	(727) 443-5700
LUAI, Za Kip	2514 N. McMullen Booth Rd.	Clearwater	FL	33761	(727) 723-0281
HRE, Jonathan Tin	1555 S Highland Ave	Clearwater	FL	33756	(727) 442-5511
THAWNG, Simon Chin	1921 North Belcher Plaza	Clearwater	FL	33763	(727) 712-3450
KEUH, Thang	1520 N. McMullen Booth Rd.	Clearwater	FL	33759	(727) 725-4900
HRE, Jonathan Tin	1555 S Highland Ave	Clearwater	FL	33756	(727) 442-5511
KEUH, Thang	1520 N. McMullen Booth Rd.	Clearwater	FL	33759	(727) 725-4900
SIAM, Siang Nei	200 Island Way	Clearwater	FL	33767	(727) 298-8618
Soe, Khaing Aye Aye	250 Citrus Tower Blvd.	Clermont	FL	34711	(352) 241-6670

Zenshi Food Service Counters

Franchise List

As of March 31, 2025

Franchisee Name	Address	City	State	Zip	Phone
TUN, Khin Ohanmar	13900 County Route 455	Clermont	FL	34711	(407) 877-1545
SANG, Thang Sian	17445 US Hwy 192	Clermont	FL	34714	(352) 243-0529
MAUNG, Kyin Sein	4351 S. Highway 27	Clermont	FL	34711	(352) 394-4437
SANG, Thang Sian	17445 US Hwy 192	Clermont	FL	34714	(352) 243-0529
MAUNG, Kyin Sein	4351 S. Highway 27	Clermont	FL	34711	(352) 394-4437
SILVA, Jinda	1720 East Highway 50	Clermont	FL	34711	(800) 242-1227
PU, Kam	7325 N. US Hwy 1	Cocoa	FL	32927-5006	(321) 635-8560
LIAN, Hang Muan	2301 State Road 524, Suite 150	Cocoa	FL	32926	(321) 636-2583
PU, Kam	7325 N. US Hwy 1	Cocoa	FL	32927-5006	(321) 635-8560
THANG, Ngo Sawm	5665 North Atlantic Ave	Cocoa Beach	FL	32931	(321) 783-1014
CIN, Thang Suan	6570 N State Rd 7	Coconut Creek	FL	33073	(954) 425-0400
LIAN, Zam Khan	5365 Lyons Rd	Coconut Creek	FL	33073	(954) 427-0563
CIN, Tuan Za	4849 Coconut Creek Pkwy	Coconut Creek	FL	33066	(954) 975-2490
CIN, Thang Suan	6570 N State Rd 7	Coconut Creek	FL	33073	(954) 425-0400
THANG, Lian Thawn	1500 Douglas Rd	Coral Gables	FL	33134	(305) 445-3221
TUANG, Khup Sian	2551 S. Le Jeune Rd.	Coral Gables	FL	33134	(305) 445-2641
TUNG, Hang Deih	1401 Monza Ave.	Coral Gables	FL	33146	(305) 667-1681
THANG, Lian Thawn	1500 Douglas Rd	Coral Gables	FL	33134	(305) 445-3221
TUANG, Khup Sian	2551 S. Le Jeune Rd.	Coral Gables	FL	33134	(305) 445-2641
MOE, Zaw Zaw	1400 Coral Ridge Dr.	Coral Springs	FL	33071	(954) 346-1705
KHUAL, Tuan Khaw	10701 Wiles Rd.	Coral Springs	FL	33076	(954) 796-2090
HTAY, Myint	5950 Coral Ridge Drive	Coral Springs	FL	33076	(954) 757-4405
PAU, Suan Thawn	6270 W. Sample Rd.	Coral Springs	FL	33067	(954) 344-5560
THANG, Hang Suan	2201 North University Drive	Coral Springs	FL	33071	(954) 757-2296
HTAY, Myint	5950 Coral Ridge Drive	Coral Springs	FL	33076	(954) 757-4405
LIAN, Ceu Uk	2343 CRAWFORDVILLE HIGHWAY	Crawfordville	FL	32327	(850) 926-4072
SANG, Zam Sian	2250 South Ferdon Blvd	Crestview	FL	32536	(850) 682-0942
SANG, Zam Sian	2250 South Ferdon Blvd	Crestview	FL	32536	(850) 682-0942
PAU, Zen Suan	1355 Fredon Blvd. N	Crestview	FL	32536	(850) 682-0820
KAM, Zam Khan	18485 S. Dixie Highway	Cutler Bay	FL	33157	(305) 235-9684
LIMBU, Suresh Kumar Samsohang	402 E. Dania Beach Blvd.	Dania Beach	FL	33004	(954) 920-4289
THAWNG, Steven	2424 Sand Mine	Davenport	FL	33897	(863) 420-6455
THAWNG, Steven	2424 Sand Mine	Davenport	FL	33897	(863) 420-6455
LING, Lian	7800 Lake Wilson Rd	Davenport	FL	33896	(863) 420-3152
LING, Lian	7800 Lake Wilson Rd	Davenport	FL	33896	(863) 420-3152
KHAI, Suan Sian	1200 Champions Dr	Davenport	FL	33897	(863) 422-0070
LIAN, Vung San	8842 W. State Rd 84	Davie	FL	33324	(954) 472-4511
KHAM, Joseph	4901 SW 148th Ave.	Davie	FL	33330	(954) 680-1900
KHAM, Joseph	4901 SW 148th Ave.	Davie	FL	33330	(954) 680-1900
HANG, Thang Sian	4701 S University Dr.	Davie	FL	33328	(954) 430-6330
KIM, Du	2595 N. Atlantic Ave.	Daytona Beach	FL	32118	(386) 677-3098
KIM, Thuam Khan	1850 Ridgewood Ave	Daytona Beach	FL	32117	(386) 677-7161
AUNG, Nyein Chan	2630 LPGA Blvd	Daytona Beach	FL	32124	(386) 274-3188
LO, Dai	1500 BEVILLE RD.	DAYTONA BEACH	FL	32114-5647	(386) 281-4623
NU, Hoih	3044 S Atlantic Ave	Daytona Beach Shores	FL	32118	(386) 788-7773
MUNG, Cia	1337 S Military Trl	Deerfield Beach	FL	33442	(954) 427-5828
UK, Van	3740 W. Hillsboro Blvd.	Deerfield Beach	FL	33442	(954) 481-2266
MUNG, Cia	1337 S Military Trl	Deerfield Beach	FL	33442	(954) 427-5828
LWE, Thin	299 E International Speedway Blvd	Deland	FL	32724	(386) 734-7112
LWE, Thin	299 E International Speedway Blvd	Deland	FL	32724	(386) 734-7112
KHUP, Daniel Cin Khual	1538 S. Federal Hwy	Delray Beach	FL	33483	(561) 272-1291
NI, Ruth Ni	13860 South Jog Rd	Delray Beach	FL	33446	(561) 498-2229
NI, Ruth Ni	13860 South Jog Rd	Delray Beach	FL	33446	(561) 498-2229
WIN, Khant Myint	555 NE 5th Ave.	Delray Beach	FL	33483	(561) 272-9460
MANG, Khup Mun	16130 Jog Rd.	Delray Beach	FL	33446	(561) 495-1367
KHUP, Daniel Cin Khual	1538 S. Federal Hwy	Delray Beach	FL	33483	(561) 272-1291
Drawitz, Annie Mueanfan	9239 Atlantic Ave	Delray Beach	FL	33446	(561) 498-1285
NI, Ruth Ni	13860 South Jog Rd	Delray Beach	FL	33446	(561) 498-2229
CIN, Vum Za	4425 Commons Dr. E	Destin	FL	32541	(850) 837-9094
THANG, Thawng Lian	7550 NW 104th Ave	Doral	FL	33178	(305) 418-9751
THANG, Thawng Lian	7550 NW 104th Ave	Doral	FL	33178	(305) 418-9751
LUAI, George Kio	1491 Main St.	Dunedin	FL	34698	(727) 736-9284
LUAI, George Kio	1491 Main St.	Dunedin	FL	34698	(727) 736-9284
SANG, Mal Sawm	11352 North William Street, Suite 4	Dunnellon	FL	34432	(352) 522-1988
PREE, Po	2970 S. Ridgewood Ave	Edgewater	FL	32141	(386) 427-6022
PREE, Po	2970 S. Ridgewood Ave	Edgewater	FL	32141	(386) 427-6022
Par, Mary Sui Cin	1500 Placida Rd Ste C	Englewood	FL	34223	(941) 475-8823
SAW, Zay Yar	55 N Indiana Ave	Englewood	FL	34223	(941) 473-5441
SAW, Zay Yar	55 N Indiana Ave	Englewood	FL	34223	(941) 473-5441
LIN, Swe Zin	55 N Indiana Ave	Englewood	FL	34223	(941) 473-5441
SANG, OBED	21301 S. Tamiami Trail	Estero	FL	33928	(239) 948-1174

Zenshi Food Service Counters

Franchise List

As of March 31, 2025

Franchisee Name	Address	City	State	Zip	Phone
THIDA, Myat	20311 Grande Oak Shoppes Blvd.	Estero	FL	33928-7662	(239) 495-8031
TUN, Nay Wynn	19050 CORKSCREW RD	ESTERO	FL	33928	(239) 675-4029
HATZAW, Thawnglang	1950 Highway 19	Eustis	FL	32726	(352) 357-4989
HATZAW, Thawnglang	1950 Highway 19	Eustis	FL	32726	(352) 357-4989
PI, Pi	24420 FL- 44	Eustis	FL	32736	(352) 357-2024
LALREMLIANA, FNU	1421 Sadler Rd.	Fernandina Beach	FL	32034	(904) 277-4911
MYINT, Sein Maung	414 Beach Village Dr.	Flagler Beach	FL	32136	(386) 517-2776
MYINT, Sein Maung	414 Beach Village Dr.	Flagler Beach	FL	32136	(386) 517-2776
LIN, Nay	865 Hibernia Road, Suite 200	Fleming Isle	FL	32003	(904) 529-1250
KHIN, BD Kyaw Moe	19100 S. Tamiami Trail	Fort Myers	FL	33908	(239) 432-2522
WONG, Taik Kam	11600 Gladiolus Dr.	Fort Myers	FL	33908	(239) 437-3674
KHIN, BD Kyaw Moe	19100 S. Tamiami Trail	Fort Myers	FL	33908	(239) 432-2522
HTOO, Myo Kyaw	11851 Palm Beach Blvd.	Fort Myers	FL	33905	(239) 690-9565
THANG, Hau Kap	2160 McGregor Blvd	Fort Myers	FL	33901	(239) 332-2403
HTOO, Myo Kyaw	11851 Palm Beach Blvd.	Fort Myers	FL	33905	(239) 690-9565
THANG, Hau Kap	2160 McGregor Blvd	Fort Myers	FL	33901	(239) 332-2403
DULA, Lalzam	3400 N. Federal Hwy	Fort Lauderdale	FL	33306	(954) 564-9612
TUANG, Kap Khan	15801 Sheridan Street	Fort Lauderdale	FL	33331	(954) 442-6869
DULA, Lalzam	3400 N. Federal Hwy	Fort Lauderdale	FL	33306	(954) 564-9612
NANG, Lian Suan	6525 Nova Drive	FORT LAUDERDALE	FL	33317	(954) 423-9599
DAL, Khup Sian	601 South Andrews Ave	Fort Lauderdale	FL	33301	(954) 728-8330
SAWM, Nang Za	1415 East Sunrise Blvd	Fort Lauderdale	FL	33304	(954) 888-8915
DAL, Khup Sian	601 South Andrews Ave	Fort Lauderdale	FL	33301	(954) 728-8330
NANG, Lian Suan	6525 Nova Drive	FORT LAUDERDALE	FL	33317	(954) 423-9599
SAWM, Nang Za	1415 East Sunrise Blvd	Fort Lauderdale	FL	33304	(954) 888-8915
BAWI, Hau	10018 Griffin Rd.	Fort Lauderdale	FL	33328	(954) 434-5728
CIN, PIANG LAM	255 SE 3rd Ave.	Fort Lauderdale	FL	33301	(954) 728-8330
DAL, Khup Sian	601 South Andrews Ave	Fort Lauderdale	FL	33301	(954) 728-8330
MAUNG, Harry Thiha	4600 Summerlin Rd.	Fort Myers	FL	33919	(239) 939-1771
ALEXANDER, Carol	20321 Summerlin Rd	Fort Myers	FL	33908	(239) 454-0145
TUN, Thi Han	5997 S. Pointe Blvd., # 106	Fort Myers	FL	33919	(239) 415-1515
ALEXANDER, Carol	20321 Summerlin Rd	Fort Myers	FL	33908	(239) 454-0145
ALEXANDER, Carol	20321 Summerlin Rd	Fort Myers	FL	33908	(239) 454-0145
TUN, Thi Han	5997 S. Pointe Blvd., # 106	Fort Myers	FL	33919	(239) 415-1515
KHUAL, Pau Suan	13650 Fiddlesticks Blvd	Fort Myers	FL	33912	(239) 768-1710
MAUNG, Aent Bohne	16980 Alico Mission Way, Suite 403	Fort Myers	FL	33908	(239) 489-0134
AUNG, Ye Moe	13401 Summerlin Road	Fort Myers	FL	33919	(239) 481-2242
MUNG, Lian Deih	13121 Paul J. Doherty Pkwy	Fort Myers	FL	33913	(239) 561-2224
LINN, Nay Maung	14561 Palm Beach Blvd	Fort Myers	FL	33905	(239) 690-0554
LINN, Nay Maung	14561 Palm Beach Blvd	Fort Myers	FL	33905	(239) 690-0554
ALEXANDER, Carol	20321 Summerlin Rd	Fort Myers	FL	33908	(239) 454-0145
THAWN, En	2517 S. Federal Hwy	Fort Pierce	FL	34982	(772) 595-1700
LAL, Biak Thasinthang	1851 N US Hwy 1	Fort Pierce	FL	34946	(772) 595-5321
LUN, Uap Khan	421 Mary Esther Cut Off NW	Fort Walton Beach	FL	32548	(850) 301-0033
LUN, Uap Khan	421 Mary Esther Cut Off NW	Fort Walton Beach	FL	32548	(850) 301-0033
LUN, Man Don	16400 US Highway 331South	Freeport	FL	32439	(850) 835-2296
MARAN, Tangnyang	NW 1200 76th Blvd	Gainesville	FL	32606	(352) 332-0661
MAW, Tin Mar	5200 NW 43rd St. Ste 401	Gainesville	FL	32606	(352) 375-5310
OO, Janet Thet	5801 SW 75th St.	Gainesville	FL	32608	(352) 375-1110
LWIN, Tint	3720 NW 13th St.	Gainesville	FL	32609	(352) 335-3785
OO, Janet Thet	5801 SW 75th St.	Gainesville	FL	32608	(352) 375-1110
MARAN, Tangnyang	NW 1200 76th Blvd	Gainesville	FL	32606	(352) 332-0661
MAW, Tin Mar	5200 NW 43rd St. Ste 401	Gainesville	FL	32606	(352) 375-5310
LWIN, Tint	3720 NW 13th St.	Gainesville	FL	32609	(352) 335-3785
LWIN, Tint	3720 NW 13th St.	Gainesville	FL	32609	(352) 335-3785
HTIN, Win	5200 SW 34th St.	Gainesville	FL	32608	(352) 375-1094
TIN, Zaw Min	SW 2755 91st St.	Gainesville	FL	32608	(352) 331-1037
Ngone, Phoo Pwint Thet	3930 South West Archer Road	Gainesville	FL	32608	(352) 379-7271
WIN, Tun Tun	4115 NW 16th Boulevard	Gainesville	FL	32605-3505	(352) 336-1488
MARAN, Hkamhtun	203 NW 13th Street	Gainesville	FL	32601	(352) 375-2775
WIN, Tun Tun	4115 NW 16th Boulevard	Gainesville	FL	32605-3505	(352) 336-1488
TIN, Zaw Min	SW 2755 91st St.	Gainesville	FL	32608	(352) 331-1037
MARAN, Hkamhtun	203 NW 13th Street	Gainesville	FL	32601	(352) 375-2775
WIN, Tun Tun	4115 NW 16th Boulevard	Gainesville	FL	32605-3505	(352) 336-1488
SANG, Ning Sian	11200 S. Military Trail	Golf	FL	33436	(561) 903-3141
MARAN, Brangshawng	6790 Forest Hill Blvd	Greenacres	FL	33413	(561) 641-4500
MARAN, Brangshawng	6790 Forest Hill Blvd	Greenacres	FL	33413	(561) 641-4500
YU, Yue Bo	7975 State Road 50	Groveland	FL	34736	(352) 429-0233
JAKOP, Tony	852 Gulf Breeze Parkway	Gulf Breeze	FL	32561	(850) 932-0113
SAO, Viseth	1430 Tiger Park Lane	Gulf Breeze	FL	32563	(850) 932-5194
KYWE, Thavone	4112 E JOHNSON AVE	HAINES CITY	FL	33844-9233	(813) 944-8865

Zenshi Food Service Counters

Franchise List

As of March 31, 2025

Franchisee Name	Address	City	State	Zip	Phone
PUM, Mang Za	1400 E. Hallandale Beach Blvd.	Hallandale Beach	FL	33009	(954) 454-6440
PUM, Mang Za	1400 E. Hallandale Beach Blvd.	Hallandale Beach	FL	33009	(954) 454-6440
HRUAI TLUANG, Jerry Biak	2685 N. Forest Ridge Rd.	Hernando	FL	34442	(352) 527-6550
HRUAI TLUANG, Jerry Biak	2685 N. Forest Ridge Rd.	Hernando	FL	34442	(352) 527-6550
PAU, Kham Khup	8601 NW 186th St.	Hialeah	FL	33015	(305) 829-0423
PAU, Kham Khup	8601 NW 186th St.	Hialeah	FL	33015	(305) 829-0423
PAU, Kham Khup	8601 NW 186th St.	Hialeah	FL	33015	(305) 829-0423
SING, Pau Khan	3339 W. 80th St	Hialeah	FL	33018	(305) 819-2600
SANGG, Vum Sawm	1585 W. 49th St.	Hialeah	FL	33010	(305) 828-2180
MANG, Thang S.	155 E. 2nd Ave	Hialeah	FL	33010	(305) 863-8133
MANG, Thang S.	155 E. 2nd Ave	Hialeah	FL	33010	(305) 863-8133
SING, Pau Khan	3339 W. 80th St	Hialeah	FL	33018	(305) 819-2600
FENG, Huanning	3685 W 85TH PATH	HIALEAH	FL	33018	(800) 242-1227
MAUNG, Steven Nyein-Chan	11750 SE Federal Hwy	Hobe Sound	FL	33455	(772) 545-5660
MAUNG, Steven Nyein-Chan	11750 SE Federal Hwy	Hobe Sound	FL	33455	(772) 545-5660
THANG, Van Lainun	4701 Sunray	Holiday	FL	34690	(727) 944-3551
THANG, Van Lainun	4701 Sunray	Holiday	FL	34690	(727) 944-3551
HLAING, Chan Mya Aye	5211 Sheridan Street	Hollywood	FL	33021	(954) 987-6331
MUNG, Jason Thang Zam	3251 Hollywood Blvd	Hollywood	FL	33021	(954) 964-5005
PUM, Mang	6901 Taft St.	Hollywood	FL	33024	(954) 961-1770
HLAING, Chan Mya Aye	5211 Sheridan Street	Hollywood	FL	33021	(954) 987-6331
PUM, Mang	6901 Taft St.	Hollywood	FL	33024	(954) 961-1770
MYINT, Aye Aye	1700 Sheridan St.	Hollywood	FL	33020	(954) 927-5680
MINN, Aye	1740 Polk St	Hollywood	FL	33020	(954) 927-7879
Huynh, Hung Tuan	10450 Pines Blvd	Hollywood	FL	33026	(954) 437-2457
CHIN, Vin Choeng	3900 E. Bay Dr.	Holmes Beach	FL	34217	(941) 778-5422
DIM, Niang Khan	891 N. Homestead Blvd	Homestead	FL	33030	(305) 242-1500
THANG, Kham Sawm	3060 N.E. 41st Terrace	Homestead	FL	33033	(305) 242-0954
NUAM, Niang Deih	2950 NE. 8th St.	Homestead	FL	33033	(305) 242-2679
ZAYYA, Aung	23300 SW 112th Avenue	Homestead	FL	33032	(305) 257-4090
KHUP, Pau	3942 S. Suncoast Blvd.	Homosassa	FL	34448-2601	(352) 621-0884
KHUP, Pau	3942 S. Suncoast Blvd.	Homosassa	FL	34448-2601	(352) 621-0884
MAR, The	13752 Little Rd.	Hudson	FL	34667	(727) 861-1990
MOE, Khaing	14851 SR 52	Hudson	FL	34669	(727) 856-0293
MAR, The	13752 Little Rd.	Hudson	FL	34667	(727) 861-1990
MAR, The	13752 Little Rd.	Hudson	FL	34667	(727) 861-1990
SAO, Visa	Building # 91013	Hurlburt Field AFB	FL	32544	(850) 881-2138
SANG, Hau Tun	700 N Miramar Ave	Indialantic	FL	32903	(321) 953-6709
NUAM, Lun Ngaih	11291 US Hwy 98 E	Inlet Beach	FL	32461	(850) 213-7031
NUAM, Lun Ngaih	11291 US Hwy 98 E	Inlet Beach	FL	32461	(850) 213-7031
SANG, Lal Ring	1012 West Main Street	Inverness	FL	34450	(352) 341-2581
TUN, Aung Myo	83268 Overseas Hwy	Islamorada	FL	33036	(305) 664-4890
CHYAWM, La Ring	12541 Yellow Bluff Road	Jackson-Duval	FL	32226	(904) 757-1304
PENG, Thla	1701 ALLEGHENY AVE	Jacksonville	FL	32212	(904) 542-5311
LIAN, Pau Khan	731 Duval Station Rd	Jacksonville	FL	32218-0804	(904) 696-3093
PUI, Te	9518 Argyle Forest Blvd.	Jacksonville	FL	32222	(904) 317-5755
LAHKUM, Naw Mun	7628 103Rd Street	Jacksonville	FL	32210	(904) 777-3122
SHWE, Myo Win	11250-4 Old Saint Augustine Rd	Jacksonville	FL	32257	(904) 262-5474
KHAI, Tuan Suan	14444 Beach Blvd. Ste 6	Jacksonville	FL	32250	(904) 223-0286
VUNG, Cing Khat	9100 Merrill Rd	Jacksonville	FL	32225	(904) 745-4260
LAHKUM, Naw Mun	7628 103Rd Street	Jacksonville	FL	32210	(904) 777-3122
Lin, Khin	12620 Beach Blvd.	Jacksonville	FL	32246	(904) 564-3580
AUNG, Soe Moe	6001 Argyle Forest Blvd	Jacksonville	FL	32244	(904) 908-5906
THANG, Pum Lam	1100 Dun Ave	Jacksonville	FL	32218	(904) 751-1445
SHWE, Myo Win	11250-4 Old Saint Augustine Rd	Jacksonville	FL	32257	(904) 262-5474
NGAIH, Dim Sian	4765 Hodges Blvd	Jacksonville	FL	32224	(904) 223-0554
CHEN, Yasu	450 State Road 13, # 109	Jacksonville	FL	32259	(904) 230-3201
SAN, Kyaw	2033 Riverside Ave.	Jacksonville	FL	32204	(904) 381-8610
THANG, John	4320 Deerwood Lake Pkwy	Jacksonville	FL	32216	(904) 620-0599
THOMAS, May	7749 Normandy Blvd.	Jacksonville	FL	32221	(904) 781-1952
MANG, Sing Cin	10500 San Jose Blvd.	Jacksonville	FL	32257	(904) 288-6660
FENG, Dian	2750 Racetrack Rd	Jacksonville	FL	32259	(904) 230-3970
SHARE, HtuSam	2845 County Rd 210 W	Jacksonville	FL	32259	(904) 230-3939
PARK, Kui Suk	13820 Old St. Augustine Rd	Jacksonville	FL	32258	(904) 262-5415
MANG, Sing Cin	10500 San Jose Blvd.	Jacksonville	FL	32257	(904) 288-6660
PARK, Kui Suk	13820 Old St. Augustine Rd	Jacksonville	FL	32258	(904) 262-5415
REM, Thang	5858 Atlantic Blvd.	Jacksonville	FL	32207-2223	(904) 721-3410
LIAN, Pau Khan	731 Duval Station Rd	Jacksonville	FL	32218-0804	(904) 696-3093
ZAW, Than Aye	11341 NORMANDY BLVD SUITE 201	JACKSONVILLE	FL	32221	(800) 242-1227
NGAIH, Dim Sian	4765 Hodges Blvd	Jacksonville	FL	32224	(904) 223-0554
LIAN, Thawng Tha	408 Beach Boulevard	Jacksonville Beach	FL	32250	(904) 249-1072

Zenshi Food Service Counters

Franchise List

As of March 31, 2025

Franchisee Name	Address	City	State	Zip	Phone
LIAN, Thawng Tha	408 Beach Boulevard	Jacksonville Beach	FL	32250	(904) 249-1072
THAWNG, Do Lian	2875 University Blvd.	Jacksonville	FL	32217	(904) 419-4807
MANG, Kam Lam	4231 N.W. Federal Highway	Jensen Beach	FL	34957	(772) 692-7090
THANG, Robert Cingo	6330 West Indiantown Rd	Jupiter	FL	33458	(561) 741-1220
KHAI, Lang Lian	4060 S. US Highway 1	Jupiter	FL	33477	(561) 694-2662
KHAI, Lang Lian	4060 S. US Highway 1	Jupiter	FL	33477	(561) 694-2662
MAUNG, Shar Shar	10142 W. Indiantown Rd	Jupiter	FL	33478	(561) 748-5812
OO, Tin Tun	5500 Military Trail	Jupiter	FL	33458	(561) 799-3181
THANG, Robert Cingo	6330 West Indiantown Rd	Jupiter	FL	33458	(561) 741-1220
OO, Tin Tun	5500 Military Trail	Jupiter	FL	33458	(561) 799-3181
THANG, Robert Cingo	6330 West Indiantown Rd	Jupiter	FL	33458	(561) 741-1220
THANG, Robert Cingo	6330 West Indiantown Rd	Jupiter	FL	33458	(561) 741-1220
MUAN , Cing Sian	9105 South Dadeland Blvd.	Kendall	FL	33156	(305) 670-8929
MUAN , Cing Sian	9105 South Dadeland Blvd.	Kendall	FL	33156	(305) 670-8929
MIN, Ye	101499 OVERSEAS HWY	KEY LARGO	FL	33037-4553	(305) 451-5338
AUNG, Maung Aung	3316 N. Roosevelt Blvd.	Key West	FL	33040	(305) 296-2225
AUNG, Maung Aung	3316 N. Roosevelt Blvd.	Key West	FL	33040	(305) 296-2225
ZA HRE, Vung Lian Htay	14928 E. Orange Lake Blvd.	Kissimmee	FL	34747	(407) 239-4989
MUNG, Kham Nun	1910 N. John Young Pkwy	Kissimmee	FL	34741	(407) 933-0367
ZA HRE, Vung Lian Htay	14928 E. Orange Lake Blvd.	Kissimmee	FL	34747	(407) 239-4989
MUNG, Kham Nun	1910 N. John Young Pkwy	Kissimmee	FL	34741	(407) 933-0367
LIAN, Sina	3839 Pleasant Hill Road	Kissimmee	FL	34746	(407) 343-7575
BATISTA, Janice Angelica	3040 Dyer Blvd	Kissimmee	FL	34741	(407) 933-0172
FERNANDEZ, Judith M.	3221 Vineland Rd	Kissimmee	FL	34746	(407) 239-1852
KHAI, Lang Khai	1120 Bichara Blvd	Lady Lake	FL	32159	(352) 750-2400
KHAI, Lang Khai	1120 Bichara Blvd	Lady Lake	FL	32159	(352) 750-2400
SU, Thiri	255 North West Commons Loop	Lake City	FL	32055	(386) 719-5446
NAING, Win	601 Weldon Blvd	Lake Mary	FL	32746	(407) 321-7616
HTOO, Kaw	825 Rinehart Rd.	Lake Mary	FL	32746-4867	(407) 322-9985
SAY, Saw Bweh	4195 W. Lake Mary Blvd.	Lake Mary	FL	32746	(407) 328-3055
VUNG, Pau Lam	870 Village Oak Lane	Lake Mary	FL	32746	(407) 804-1950
NAING, Win	601 Weldon Blvd	Lake Mary	FL	32746	(407) 321-7616
NAING, Win	601 Weldon Blvd	Lake Mary	FL	32746	(407) 321-7616
NAING, Win	601 Weldon Blvd	Lake Mary	FL	32746	(407) 321-7616
FANAI, Lalpui Thanga	23965 U.S. Highway 27	LAKE WALES	FL	33859	(863) 676-1215
FANAI, Lalpui Thanga	23965 U.S. Highway 27	LAKE WALES	FL	33859	(863) 676-1215
KHAING, Soe Min	102 State Rd 60E.	Lake Wales	FL	33853	(863) 676-0511
KHAING, Soe Min	102 State Rd 60E.	Lake Wales	FL	33853	(863) 676-0511
HTWE, Thant Zaw	1700 S. Congress Ave.	Lake Worth	FL	33461	(561) 965-8700
LIAN, Dal Za	7745 Lake Worth Rd	Lake Worth	FL	33463	(561) 969-3880
Vongpaphan, Kenny James	8899 HYPOLUX RD.	Lake Worth	FL	33467	(561) 304-0697
HUGEWIN, Brian Wong	9855 Lake Worth Rd	Lake Worth	FL	33467	(561) 966-9111
LIAN, Dal Za	7745 Lake Worth Rd	Lake Worth	FL	33463	(561) 969-3880
Vongpaphan, Kenny James	8899 HYPOLUX RD.	Lake Worth	FL	33467	(561) 304-0697
HUGEWIN, Brian Wong	9855 Lake Worth Rd	Lake Worth	FL	33467	(561) 966-9111
KHAI, Thomas Thang Khan	214 North Dixie Highway	Lake Worth	FL	33460	(561) 493-5042
LYAN, Michael	2125 E CR 540	Lakeland	FL	33813	(863) 607-4522
SIAM, Lal Hmun	2300 Griffin Rd	Lakeland	FL	33810	(863) 858-1146
LYAN, Michael	2125 E CR 540	Lakeland	FL	33813	(863) 607-4522
TANG, Chi Lung	5185 US Hwy 98 S	Lakeland	FL	33812	(863) 644-0386
HAN, Min	2515 South Florida Avenue	Lakeland	FL	33803	(863) 683-9860
MAUNG, Okkar	5140 County Line Road	Lakeland	FL	33811	(863) 644-1376
SIAM, Lal Hmun	2300 Griffin Rd	Lakeland	FL	33810	(863) 858-1146
PER, Zing	1617 US Hwy 98 S	Lakeland	FL	33801	(863) 413-0626
PER, Zing	1617 US Hwy 98 S	Lakeland	FL	33801	(863) 413-0626
YARZAR, Htoo	7340 Kathleen Road	Lakeland	FL	33810	(893) 816-0379
HAN, Min	2515 South Florida Avenue	Lakeland	FL	33803	(863) 683-9860
TUN, Kyaw Thurein	7325 University Parkway	Lakewood Ranch	FL	34202	(941) 355-8803
MAWII, Lily Neikip	2121 Collier Parkway	Land O Lakes	FL	34639	(813) 948-9819
MAUNG, Nyint Win	7830 Land O Lakes Blvd.	Land O Lakes	FL	34638	(813) 996-3391
KHUP, Paul	857 W. Bay Dr.	Largo	FL	33770-3221	(727) 518-7747
MANG, Nem Ngaih	10411 Ulmerton Rd.	Largo	FL	33771	(727) 588-1285
KHUP, Paul	857 W. Bay Dr.	Largo	FL	33770-3221	(727) 518-7747
MANG, Nem Ngaih	10411 Ulmerton Rd.	Largo	FL	33771	(727) 588-1285
VAAK, David Khua	5855 West Oakland Blvd	Lauderhill	FL	33313	(954) 735-1328
THWE, Mi Mi	27615 U.S Highway 27	Leesburg	FL	34748	(352) 787-0440
LIAN, Khan Suan	717 N 14th St.	Leesburg	FL	34748	(352) 787-4176
THANG, Vial Saluai	10601 US 441, Suite D	Leesburg	FL	34788	(352) 323-1420
LIAN, Khan Suan	717 N 14th St.	Leesburg	FL	34748	(352) 787-4176
OO, Nay Phone Maw	5781 Lee Blvd	Lehigh Acres	FL	33971	(239) 226-9701
NGAIHTE, Gin Siamlian	1328 Homestead Road North	Lehigh Acres	FL	33936	(239) 368-2241

Zenshi Food Service Counters

Franchise List

As of March 31, 2025

Franchisee Name	Address	City	State	Zip	Phone
MYAT, Tinma	3700 N. Federal Hwy	Lighthouse Point	FL	33064	(954) 786-3056
MUNG, Suankim	2450 N. Federal Highway	Lighthouse Point	FL	33064	(954) 784-3011
MUNG, Suankim	2450 N. Federal Highway	Lighthouse Point	FL	33064	(954) 784-3011
TAN, Andrew Win	2215 Ohio Avenue N	Live Oak	FL	32064	(386) 339-6378
KYAW, Aye	2381 W. State Rd 434	Longwood	FL	32779	(407) 865-9847
KU, Kaw	675 Longwood Hills Rd	Longwood	FL	32750	(321) 207-3311
PIANG, Lal Siam	3939 Van Dyke Rd	Lutz	FL	33558	(813) 264-5591
ZAW, Kyaw	16560 North Nebraska	Lutz	FL	33549	(813) 264-5590
HRIM, Thang	18901 State Road 54	Lutz	FL	33558	(813) 948-1275
PAR, Belle Tial	2801 E County Line Rd	Lutz	FL	33559	(800) 242-1227
DIM, Gin Lam	2310 South Highway 77	Lynn Haven	FL	32444	(850) 271-6180
DA VITORIA LOBO, Sabei	242 N. Orlando Ave.	Maitland	FL	32751	(407) 599-0202
MUNG, Kham Sian	262 South Ocean Blvd.	Manalapan	FL	33462	(561) 585-6790
MUNG, Kham Sian	262 South Ocean Blvd.	Manalapan	FL	33462	(561) 585-6790
WU, Park Hein	5407 Overseas Highway	Marathon	FL	33050	(305) 289-2920
AUNG, May Thet	1089 N Collier Blvd Ste 401	Marco Island	FL	34145	(239) 642-2202
AUNG, May Thet	1089 N Collier Blvd Ste 401	Marco Island	FL	34145	(239) 642-2202
EN, Gin Khan	7777 N. Wickham Rd	Melbourne	FL	32940	(321) 253-6142
HLAING, Nan Moe Sandar	1411 S Babcock St	Melbourne	FL	32901	(321) 727-8085
THAWNG, JC	4100 N. Wickham Rd	Melbourne	FL	32935	(321) 242-2678
EN, Gin Khan	7777 N. Wickham Rd	Melbourne	FL	32940	(321) 253-6142
THAWNG, JC	4100 N. Wickham Rd	Melbourne	FL	32935	(321) 242-2678
HLAING, Nan Moe Sandar	1411 S Babcock St	Melbourne	FL	32901	(321) 727-8085
ZUM, Thawng Mun	3830 S. Hwy A1a	Melbourne Beach	FL	32951	(321) 725-3305
THUAM, Merry	125 E. Merritt Island Causeway	Merritt Island	FL	32952	(321) 452-0288
THWIN, Myo Mimi	8341 W. Flagler St.	Miami	FL	33144	(305) 266-0713
SUM, Mang Kap	10201 Hammocks Blvd. #111	Miami	FL	33196	(305) 382-3002
KYAW, Moe	9755 NW 41st St.	Miami	FL	33178	(305) 591-2145
OO, Ohn Mar	7805 S.W. 40th St.	Miami	FL	33155	(305) 266-1950
MOON, Michael	311 SW 7th St.	Miami	FL	33130	(305) 860-9477
LYAN, Zam Za	13820 SW 88th St	Miami	FL	33186	(305) 385-0200
AYE, Tin Tun	2270 SW 27th Ave.	Miami	FL	33145	(305) 445-9661
ZO, Vung Sian	13890 SW 56th St.	Miami	FL	33175	(305) 387-3100
BIEH, Thang Za	14601 S. Dixie Hwy	Miami	FL	33176	(305) 255-8005
THANG, Ai Zam	14630 SW 26th St.	Miami	FL	33175	(305) 223-0332
THANG, Jacob	8250 Mills Dr.	Miami	FL	33183	(305) 274-2420
KHUAL, Suan Khan	13735 SW 152nd St.	Miami	FL	33177	(305) 251-9889
TUANG, Cin Mun	13850 SW 8th St.	Miami	FL	33184	(305) 221-1924
HANG, Tang Zou	20425 Old Cutler Rd	Miami	FL	33189	(305) 235-2214
MANG, Thang Khan	1525 SW 107th Ave.	Miami	FL	33174	(305) 552-8733
HANG, Tang Zou	20425 Old Cutler Rd	Miami	FL	33189	(305) 235-2214
AYE, Than Than	15750 SW 72nd St.	Miami	FL	33193	(305) 383-6990
LUN, Cing Za	9041 SW 107th Ave.	Miami	FL	33176	(305) 273-2185
THAN, Nyo Nyo	134 SW 13th St.	Miami	FL	33130	(305) 860-2280
DA, Ti	4260 SW 152nd Ave.	Miami	FL	33185	(305) 222-8120
BIEH, Thang Za	14601 S. Dixie Hwy	Miami	FL	33176	(305) 255-8005
HANG, Thang Doe	10755 NW 58th St	Miami	FL	33178	(305) 597-8295
LYAN, Zam Za	13820 SW 88th St	Miami	FL	33186	(305) 385-0200
MUANG, Vung Sian	4870 Biscayne Blvd	Miami	FL	33137	(305) 573-8601
LYAN, Zam Za	13820 SW 88th St	Miami	FL	33186	(305) 385-0200
ZO, Vung Sian	13890 SW 56th St.	Miami	FL	33175	(305) 387-3100
WIN, Kyaw Zaw	911 SW 1st Avenue	Miami	FL	33130	(305) 358-1575
LIAN, No Khai	15771 SW 152nd St.	Miami	FL	33187	(305) 971-2623
THET, Bernice May	5715 NW 7th Street	Miami	FL	33126	(305) 266-1733
KHAAN, Zam Teng	20201 S.W. 127th Ave.	Miami	FL	33177	(305) 234-6038
LIAN, Thang Suan	8680 South West 24th Street	Miami	FL	33155	(305) 559-8030
HANG, Tang Zou	20425 Old Cutler Rd	Miami	FL	33189	(305) 235-2214
KIM, Thang Muan	18280 South West 147th Avenue	Miami	FL	33187	(305) 256-3102
LIAN, Paul Thuam	106 Ponce de Leon Blvd.	Miami	FL	33135	(305) 442-6018
KHUAL, Suan Khan	13735 SW 152nd St.	Miami	FL	33177	(305) 251-9889
DAL, Lian Za	1776 Biscayne Blvd.	Miami	FL	33132	(305) 358-3433
BIEH, Thang Za	14601 S. Dixie Hwy	Miami	FL	33176	(305) 255-8005
AYE, Than Than	15750 SW 72nd St.	Miami	FL	33193	(305) 383-6990
THANG, Biak Lian	9951 West Flagler Street	Miami	FL	33174	(305) 207-2329
THANG, Anthony Pau Kap	1420 NW North River Dr	Miami	FL	33125	(305) 424-3300
LIAN, Niang Kaih	601 NW 2nd Ave	Miami	FL	33136	(305) 374-6806
KAP, Pau Za	13005 SOUTHWEST 89TH PLACE	Miami	FL	33176	(800) 242-1227
THANG, Ai Zam	14630 SW 26th St.	Miami	FL	33175	(305) 223-0332
KAP, Pau Za	13005 SOUTHWEST 89TH PLACE	Miami	FL	33176	(800) 242-1227
KYAW, Moe	9755 NW 41st St.	Miami	FL	33178	(305) 591-2145
MANG, Thang Tul	1045 Dade Blvd.	Miami Beach	FL	33139	(305) 534-4621

Zenshi Food Service Counters

Franchise List

As of March 31, 2025

Franchisee Name	Address	City	State	Zip	Phone
TIM, Than	1920 West Avenue	Miami Beach	FL	33139	(305) 535-4268
AUNG, May May	1100 6th Street	Miami Beach	FL	33139	(305) 535-2212
AUNG, May May	1100 6th Street	Miami Beach	FL	33139	(305) 535-2212
PAU, Enn	19955 NW 2ND AVENUE	Miami Gardens	FL	33169	(305) 654-5771
PAU, Enn	19955 NW 2ND AVENUE	Miami Gardens	FL	33169	(305) 654-5771
LIU, Guokuan	15000 Miami Lakes Dr. E.	Miami Lakes	FL	33014	(305) 818-8830
NUAM, Lal	2640 Blanding Blvd.	Middleburg	FL	32068	(904) 291-5123
NGUYEN, Long Kim	5854 Dogwood Dr	Milton	FL	32570	(850) 626-2412
LI, Jinda	1685 N. Hancock Rd	Minneola	FL	34711	(352) 241-9002
LI, Jinda	1685 N. Hancock Rd	Minneola	FL	34711	(352) 241-9002
PAU, Josef Lun	6890 Miramar Blvd	Miramar	FL	33023	(954) 966-9100
PAU, Josef Lun	6890 Miramar Blvd	Miramar	FL	33023	(954) 966-9100
PAU, Josef Lun	6890 Miramar Blvd	Miramar	FL	33023	(954) 966-9100
KHAI, Pau Lian	14375 Miramar Pkwy	Miramar	FL	33027	(954) 447-9212
THANG, Kam Tung Mung	18409 Miramar Pkwy	Miramar	FL	33029	(954) 447-3334
THANG, Kam Tung Mung	18409 Miramar Pkwy	Miramar	FL	33029	(954) 447-3334
KHAI, Pau Lian	14375 Miramar Pkwy	Miramar	FL	33027	(954) 447-9212
KHAI, Pau Lian	14375 Miramar Pkwy	Miramar	FL	33027	(954) 447-9212
SHEING, Sai Saw	12681 Miramar Parkway	Miramar	FL	33027	(954) 602-5242
MYERS, Paz Lamban	18995 US Highway 441	Mount Dora	FL	32757	(352) 383-0368
NU, Kim	6551 N Orange Blossom Trl Ste 155	Mount Dora	FL	32757	(352) 383-0740
LIAN, Kham Hau	8140 West Mcnab Rd	N Lauderdale	FL	33068	(954) 722-0599
MANG, Tun Khan	1297 S State Rd	N. Lauderdale	FL	33068	(954) 973-3337
MANG, Tun Khan	1297 S State Rd	N. Lauderdale	FL	33068	(954) 973-3337
PAU, Kham Suan	11566 US Hwy 1	N. Palm Beach	FL	33408	(561) 622-0804
BEITA, Thaizi Zalen	4370 Thomasson Dr.	Naples	FL	34112-6725	(239) 774-1072
OO, Ryan	7101 Radio Rd	Naples	FL	34104	(239) 455-3001
MON, Ei Zar	11200 US 41 N	Naples	FL	34110	(239) 592-5005
LIAN, Ni	5991 Pine Ridge Rd Ext	Naples	FL	34119	(239) 352-2200
MOE, Aye Chan	2310 Pine Ridge Rd.	Naples	FL	34109	(239) 435-0387
BEITA, Thaizi Zalen	4370 Thomasson Dr.	Naples	FL	34112-6725	(239) 774-1072
MON, Ei Zar	11200 US 41 N	Naples	FL	34110	(239) 592-5005
WIN, Zin N	2450 Vanderbilt Beach Rd.	Naples	FL	34109	(239) 513-1356
OO, Tin Nyo	15265 Collier Blvd	Naples	FL	34119	(239) 348-2931
BEITA, Thaizi Zalen	4370 Thomasson Dr.	Naples	FL	34112-6725	(239) 774-1072
KHUP, Khan Za	12975 Collier Blvd Ste# 200	Naples	FL	34116	(239) 304-3394
OO, Tin Nyo	15265 Collier Blvd	Naples	FL	34119	(239) 348-2931
WIN, Zin N	2450 Vanderbilt Beach Rd.	Naples	FL	34109	(239) 513-1356
WIN, Shwe T	4860 Davis Blvd	Naples	FL	34104	(239) 732-7216
AUNG, Alex	13550 Immokalee Rd.	Naples	FL	34120	(239) 455-1654
BESSENT, Kannika	15050 Sandpiper Lane	Naples	FL	34114	(239) 732-5978
OO, May Sabe	Naples Towne Centre	Naples	FL	34112	(813) 712-3054
SOE, Myint	630 Atlantic Blvd.	Neptune Beach	FL	32266-4026	(904) 241-0944
WIN, Khin Yu Yu	9850 Little Rd	New Port Richey	FL	34654	(727) 862-5866
WIN, Khin Yu Yu	9850 Little Rd	New Port Richey	FL	34654	(727) 862-5866
SAN , Myo	5324 Little Rd.	New Port Richey	FL	34655	(727) 375-5377
PHUE, Spea	11400 Ridge Rd.	New Port Richey	FL	34654	(727) 848-4185
WIN, Khin Yu Yu	9850 Little Rd	New Port Richey	FL	34654	(727) 862-5866
ZUNG, Ngun	5127 US HWY 19 South	New Port Richey	FL	34652	(727) 848-6521
MOUH, Mouh	709 E. 3rd Ave.	New Smyrna Beach	FL	32169	(386) 428-6465
MOUH, Mouh	709 E. 3rd Ave.	New Smyrna Beach	FL	32169	(386) 428-6465
MOUH, Mouh	709 E. 3rd Ave.	New Smyrna Beach	FL	32169	(386) 428-6465
MOUH, Mouh	709 E. 3rd Ave.	New Smyrna Beach	FL	32169	(386) 428-6465
MOUH, Mouh	709 E. 3rd Ave.	New Smyrna Beach	FL	32169	(386) 428-6465
AUNG, Tun Min	1091 Tamiami Trail N	Nokomis	FL	34275	(941) 484-2606
AUNG, Tun Min	1091 Tamiami Trail N	Nokomis	FL	34275	(941) 484-2606
AUNG, Tun Min	1091 Tamiami Trail N	Nokomis	FL	34275	(941) 484-2606
CIN, Thang Khan	17960 North Tamiami Trail	North Fort Myers	FL	33903	(239) 543-2203
CIN, Thang Khan	17960 North Tamiami Trail	North Fort Myers	FL	33903	(239) 543-2203
KHAM, Hang Lian	12855 N.E. 6th Ave.	North Miami	FL	33161	(305) 891-1024
KHAM, Hang Lian	12855 N.E. 6th Ave.	North Miami	FL	33161	(305) 891-1024
NUAM, Cing Vang	1700 N.E. Miami Gardens Dr.	North Miami Beach	FL	33179	(305) 945-7119
HANG, Kham Kap	14641 Biscayne Blvd.	North Miami Beach	FL	33181	(305) 354-2171
ZAM, Hau Go	930 North Miami Beach Boulevard	North Miami Beach	FL	33162	(305) 947-5485
CIN, Nang Khan	374 Northlake BLVD.	North Palm Beach	FL	33408	(561) 842-1193
CIN, Nang Khan	374 Northlake BLVD.	North Palm Beach	FL	33408	(561) 842-1193
MAUNG, Khin Maung	1291 S. Sumter Blvd.	North Port	FL	34287	(941) 426-6672
Naing, Nay Myo	1251 South Toledo Blade Blvd	North Port	FL	34288	(941) 240-5023
MAUNG, Khin Maung	1291 S. Sumter Blvd.	North Port	FL	34287	(941) 426-6672
PABAWI, Kinglone	3450 E. Silver Springs Blvd.	Ocala	FL	34470	(352) 671-3443
KIM, Kham Sian	7578 SE Maricamp Rd	Ocala	FL	34472	(352) 687-8200

Zenshi Food Service Counters

Franchise List

As of March 31, 2025

Franchisee Name	Address	City	State	Zip	Phone
BETANCOURT, Antonio	5400 S.W. College Rd.	Ocala	FL	34474	(352) 873-1936
BETANCOURT, Antonio	5400 S.W. College Rd.	Ocala	FL	34474	(352) 873-1936
PABAWI, Kinglone	3450 E. Silver Springs Blvd.	Ocala	FL	34470	(352) 671-3443
BETANCOURT, Antonio	5400 S.W. College Rd.	Ocala	FL	34474	(352) 873-1936
HUALI, Lun Man	2575 SW 42nd Street	Ocala	FL	34471	(352) 237-3748
VUNG, Don Lian	2655 NE 35th Street	Ocala	FL	34479	(352) 620-1451
VAN HMUN MAWI, Joseph C.	8863 W. Colonial Dr.	Ocoee	FL	34761	(407) 299-4550
OO, Nan Htike	2600 Maguire Blvd	Ocoee	FL	34761	(407) 656-9343
VAN HMUN MAWI, Joseph C.	8863 W. Colonial Dr.	Ocoee	FL	34761	(407) 299-4550
GRANDEZ, Nelida M.	12500 SR 54	Odessa	FL	33556	(727) 375-5249
TUN, Saw Tun	2175 Sembler Dr.	Odessa	FL	33556	(813) 926-3660
MUNG, Cin Deih	3551 US-441	Okeechobee	FL	34974-6247	(863) 763-3500
HOO, Hser Tha You	2556 Enterprise Rd	Orange City	FL	32763	(386) 774-8255
KIM, Peter	5000-11 US Highway 17 S	Orange Park	FL	32003	(904) 269-3600
U, Ye Myint	410 Blanding Blvd	Orange Park	FL	32073	(904) 276-6016
WIN, Aung	950 Blanding Blvd.	Orange Park	FL	32065	(904) 276-6029
CIN, Zam Sian	1075 Oakleaf Plantation Pkwy	Orange Park	FL	32065	(904) 291-5108
HNUN, Hnun	4870 South Apopka Vineland Rd	Orlando	FL	32819	(407) 909-8080
SIT, Hmun Hmun	4606 S. Kirkman Rd	Orlando	FL	32811	(407) 293-7673
HTIKE, Than	3972 Town Center Blvd.	Orlando	FL	32837	(407) 850-4351
MYINT, Hla Hla	2873 S. Orange Ave.	Orlando	FL	32806	(407) 872-0395
KYAW, MICHAEL AUNG	5265 John Young Pkwy	Orlando	FL	32839	(407) 816-8335
SAW, George	1921 S. Alafaya Trail	Orlando	FL	32828	(407) 277-3117
HTIKE, Than	3972 Town Center Blvd.	Orlando	FL	32837	(407) 850-4351
MAUNG, Rai Zan	2015 Edgewater Dr.	Orlando	FL	32804	(407) 872-0173
MAUNG, Rai Zan	2015 Edgewater Dr.	Orlando	FL	32804	(407) 872-0173
LWIN, Thet	4402 Curry Ford Rd	Orlando	FL	32812-2709	(407) 282-7997
OO, Myat Noe	7640 Sand Lake Rd	Orlando	FL	32819	(407) 226-3315
ZAW, Danny Than	8145 Vineland Ave	Orlando	FL	32821	(407) 238-9924
WYNN, Nwe Ni	4501 Hoffner Ave.	Orlando	FL	32812	(407) 850-1018
MAN, Lal Nei	10615 Narcoossee Rd.	Orlando	FL	32832	(407) 277-1089
CIN, Gin Thawn	16825 E Colonial Dr	Orlando	FL	32820-0858	(407) 568-0858
SWE, Myat	6485 S. Chickasaw Trail	Orlando	FL	32829	(407) 277-8095
NO, Niang Ngaih	1501 Meeting Place	Orlando	FL	32814	(407) 897-7363
PYONE, Hnin Ei	3400 Avalon Park E. Blvd	Orlando	FL	32828	(407) 277-1043
NIANG, Hau Dim	13850 Landstar Blvd	Orlando	FL	32824	(407) 856-6040
SAW, George	1921 S. Alafaya Trail	Orlando	FL	32828	(407) 277-3117
LWIN, Thet	4402 Curry Ford Rd	Orlando	FL	32812-2709	(407) 282-7997
KYAW, MICHAEL AUNG	5265 John Young Pkwy	Orlando	FL	32839	(407) 816-8335
TIAL, Sung Hnem	9930 Universal Boulevard	Orlando	FL	32819	(407) 996-8400
DE ALMEIDA, Dimerson Fujino	13900 Narcoossee Rd.	Orlando	FL	32832	(407) 240-2102
ZAW, Danny Than	8145 Vineland Ave	Orlando	FL	32821	(407) 238-9924
MUNG, Gin Pian	7524 Dr. Phillips Blvd	Orlando	FL	32819	(407) 226-9882
OO, Khun Win	12231 E Colonia Dr.	Orlando	FL	32826	(407) 482-1244
LIAN, Angela Ni Siang	4042 S. Semoran Blvd.	Orlando	FL	32822	(407) 277-3871
LIAN, Angela Ni Siang	4042 S. Semoran Blvd.	Orlando	FL	32822	(407) 277-3871
THANG, Mas Van Uk	5350 Central Florida Pkwy	Orlando	FL	32821	(407) 465-1139
NIANG, Hau Dim	13850 Landstar Blvd	Orlando	FL	32824	(407) 856-6040
NYEIN, Thi Thi	3171 S Orange Ave	Orlando	FL	32806	(407) 492-8328
HTIKE, Than	3972 Town Center Blvd.	Orlando	FL	32837	(407) 850-4351
HNUN, Hnun	4870 South Apopka Vineland Rd	Orlando	FL	32819	(407) 909-8080
HEYL, Chadarat Khruewan	11286 DOWDEN ROAD	ORLANDO	FL	32832	(800) 242-1227
PYONE, Hnin Ei	3400 Avalon Park E. Blvd	Orlando	FL	32828	(407) 277-1043
THU, Aung Kyaw	1478 W. Granada Blvd.	Ormond Beach	FL	32174	(386) 673-5380
UK, Khrih Nun	1258 Ocean Shore Blvd.	Ormond Beach	FL	32176	(386) 441-9839
CHUAN, Windy Lal Hma	220 N. Nova Road	Ormond Beach	FL	32174	(386) 672-5724
THAL, Ngai Mang	10 E. Granada Blvd.	Ormond Beach	FL	32176	(386) 672-8643
OO, Zaw Naing	4250 Alafaya Trail STE 148	Oviedo	FL	32765	(407) 366-9480
SEIN, Tin	2100 Winter Springs Blvd	Oviedo	FL	32765	(407) 366-9740
SEIN, Tin	2100 Winter Springs Blvd	Oviedo	FL	32765	(407) 366-9740
KHAI, Pau Dem	2871 Clayton Crossing Way	Oviedo	FL	32765	(407) 673-0829
PU, Mang	443 W. CR 419 Suite 1001	Oviedo	FL	32766	(407) 366-4727
OO, Zaw Naing	4250 Alafaya Trail STE 148	Oviedo	FL	32765	(407) 366-9480
KAP, Tun Cin	4739 Highway 90	Pace	FL	32571-1403	(850) 994-4816
KAP, Tun Cin	4739 Highway 90	Pace	FL	32571-1403	(850) 994-4816
TUN, Kyaw Khine	171 Town and Country Dr.	Palatka	FL	32177	(386) 312-8345
HLAING, Mee Kyu	4711 Babcock St NE	Palm Bay	FL	32905	(321) 724-4724
HTWE, San Dar	1150 Malabar Rd SE	Palm Bay	FL	32907	(321) 727-3654
BAWI, Lang	3450 Bayside Lakes Blvd SE	Palm Bay	FL	32909	(321) 725-2420
HLAING, Mee Kyu	4711 Babcock St NE	Palm Bay	FL	32905	(321) 724-4724
SWE, Myint Myint	9179 BABCOCK ST	Palm Bay	FL	32909	(800) 242-1227

Zenshi Food Service Counters

Franchise List

As of March 31, 2025

Franchisee Name	Address	City	State	Zip	Phone
PIANG, Pau Khan	10913 N. Military Trail	Palm Beach Gardens	FL	33410	(561) 622-3584
MUNG, Joseph Zamsan	4200 Northlake Blvd.	Palm Beach Gardens	FL	33410	(561) 625-9632
PIANG, Pau Khan	10913 N. Military Trail	Palm Beach Gardens	FL	33410	(561) 622-3584
SING, Khen Kim	4101 Hood Road	Palm Beach Gardens	FL	33410	(561) 622-1047
AYE, San San	5410 Donald Ross Rd.	Palm Beach Gardens	FL	33418	(561) 626-1950
LWIN, Tun	2750 SW Martin Downs Blvd	Palm City	FL	34990	(772) 781-3012
LWIN, Tun	2750 SW Martin Downs Blvd	Palm City	FL	34990	(772) 781-3012
LORLA, Saw	5415 N. Oceanshore Blvd.	Palm Coast	FL	32137	(386) 445-2193
OO, Khatta Myint	800 Belle Terre Pkwy	Palm Coast	FL	32164	(386) 437-2426
PAR, Emily Sui Nuam	250 Palm Coast Parkway NE	Palm Coast	FL	32137	(386) 597-4776
LIAN, David Thar	33343 US Highway 19 N	Palm Harbor	FL	34684	(727) 789-1920
THIRI, Chaw	36301 E. Lake Rd.	Palm Harbor	FL	34685	(727) 785-5521
THAN, Hrang	30535 US Hwy 19 N	Palm Harbor	FL	34684	(727) 787-8802
LIAN, David Thar	33343 US Highway 19 N	Palm Harbor	FL	34684	(727) 789-1920
LIAN, David Thar	33343 US Highway 19 N	Palm Harbor	FL	34684	(727) 789-1920
SANG, Daniel Sui	1101 8th Avenue West	Palmetto	FL	34221	(941) 721-8548
PINE, Calvin Thuring	9520 Buffalo Rd	Palmetto	FL	34221	(941) 722-0693
PINE, Calvin Thuring	9520 Buffalo Rd	Palmetto	FL	34221	(941) 722-0693
LEWIS, James Tin	650 W. 23rd St.	Panama City	FL	32405	(850) 747-9780
LEWIS, James Tin	650 W. 23rd St.	Panama City	FL	32405	(850) 747-9780
MANGNGAIH, Nang	2419 Thomas Drive	Panama City Beach	FL	32408	(850) 236-4415
ULUNG, Nawsan	11240 Panama City Beach Pkwy	Panama City Beach	FL	32407	(850) 236-4515
MANGNGAIH, Nang	2419 Thomas Drive	Panama City Beach	FL	32408	(850) 236-4415
DIM, Lai	8095 University Dr.	Parkland	FL	33067	(954) 575-8225
WIN, Than Zaw	11245 N. US Highway 301 N	Parrish	FL	34219	(941) 776-8326
TUN, Phyo Myint	9005 US Highway 301 N	Parrish	FL	34219	(941) 776-8084
TUN, Phyo Myint	9005 US Highway 301 N	Parrish	FL	34219	(941) 776-8084
ME, Me	1225 S Patrick Dr.	Patrick AFB	FL	32925	(321) 494-5841
ME, Me	1225 S Patrick Dr.	Patrick AFB	FL	32925	(321) 494-5841
LIAN, Cin Khaw	600 N. University Dr.	Pembroke Pines	FL	33024	(954) 433-4400
KO, Nwe Ni	170 S. Flamingo Rd	Pembroke Pines	FL	33027	(954) 437-9500
SING, Lian En	18341 Pines Blvd.	Pembroke Pines	FL	33029	(954) 430-6100
SING, Lian En	18341 Pines Blvd.	Pembroke Pines	FL	33029	(954) 430-6100
SUAN, Hau Z	1657 N Hiatus	Pembroke Pines	FL	33026	(954) 442-7391
KO, Nwe Ni	170 S. Flamingo Rd	Pembroke Pines	FL	33027	(954) 437-9500
NU, Cing	5800 West Highway 98	Pensacola	FL	32507	(850) 452-6880
NU, Cing	5800 West Highway 98	Pensacola	FL	32507	(850) 452-6880
TLING, Tha	5055 North 9th Street	Pensacola	FL	32504	(850) 484-9646
MUNG, LUAN KHEN	5998 Mobile Highway	Pensacola	FL	32526	(850) 941-8101
KHAM, Do Khan	2180 West Nine Mile Rd.	Pensacola	FL	32534	(850) 473-5020
LIAN, Mang Kap	1100 E. Cervantes St.	Pensacola	FL	32501	(850) 434-3469
TLING, Tha	5055 North 9th Street	Pensacola	FL	32504	(850) 484-9646
NU, Cing	5800 West Highway 98	Pensacola	FL	32507	(850) 452-6880
NUNG, Suan Sian Tung	9500 W HIGHWAY 98	PENSACOLA	FL	32506	(850) 823-5871
KHAI, Mang Khan	7333 Park Blvd	Pinellas Park	FL	33781	(727) 546-5866
KHAI, Mang Khan	7333 Park Blvd	Pinellas Park	FL	33781	(727) 546-5866
MYINT, John Hla	4701 Park Blvd.	Pinellas Park	FL	33781	(727) 546-4870
KHAI, Mang Khan	7333 Park Blvd	Pinellas Park	FL	33781	(727) 546-5866
UK, David Vanlian	2515 Thonotosassa Rd	Plant City	FL	33563	(813) 719-6933
UK, David Vanlian	2515 Thonotosassa Rd	Plant City	FL	33563	(813) 719-6933
TUANG, Thang Lam	6921 W. Broward Blvd	Plantation	FL	33317	(954) 327-9705
AYE AYE, Ma Khin	225 S. Flamingo Rd	Plantation	FL	33325	(954) 472-5110
CING, Vung Sian	1181 South University Drive	Plantation	FL	33324	(954) 577-0542
TUANG, Thang Lam	6921 W. Broward Blvd	Plantation	FL	33317	(954) 327-9705
Oo, Hnin Hay Man	841 Cypress Pkwy	Poinciana	FL	34759-3408	(321) 697-5487
NIANG, Vung Lam	1140 SW 36th Ave	Pompano Beach	FL	33069	(954) 975-0119
THET, Nan Sabal	1405 S. Federal Hwy	Pompano Beach	FL	33062-7233	(954) 784-3725
MYAT, Ronny Tun Nyein	2511 E Atlantic Blvd	Pompano Beach	FL	33062	(954) 786-7964
RUAL, Than	3777 Palm Valley Rd.	Ponte Vedra	FL	32082	(904) 273-6565
RUAL, Than	3777 Palm Valley Rd.	Ponte Vedra	FL	32082	(904) 273-6565
MANG, Simon Khai Thawn	250 Pine Lake Dr	Ponte Vedra	FL	32081	(904) 826-3356
HTWEE, Saw Aung	220 Front Street	Ponte Vedra Beach	FL	32082	(904) 280-5440
WIN, Kyaw Tun	13435 MC. Call Road	Port Charlotte	FL	33981	(941) 697-0279
HTWE, Kyaw Zin	24051 Peachland Blvd	Port Charlotte	FL	33954	(941) 235-4460
CEU, Than	3821 South Nova Rd.	Port Orange	FL	32127	(386) 788-2220
SUI, Rebecah Beku	1660 Taylor Road	Port Orange	FL	32128	(386) 760-7332
HTET, Lin Myat	7037 ridge Rd	Port Richey	FL	34668	(727) 844-3955
THANG, Tuan Do	9100 U.S 1	Port Saint Lucie	FL	34952	(772) 337-1600
THANG, Tuan Do	9100 U.S 1	Port Saint Lucie	FL	34952	(772) 337-1600
PAU, John Thang	5473 St. James Drive	Port St. Lucie	FL	34983	(772) 878-6119
PAU, John Thang	5473 St. James Drive	Port St. Lucie	FL	34983	(772) 878-6119

Zenshi Food Service Counters

Franchise List

As of March 31, 2025

Franchisee Name	Address	City	State	Zip	Phone
TUANG, Lam	10400 S.W. Village Center Drive	Port St. Lucie	FL	34987	(772) 345-9900
AUNG, Khant Min	788 S.E. Becker Rd.	Port St. Lucie	FL	34984	(772) 336-3182
Maung, Zwe Wint	9335 SW Commerce Centre Dr.	Port St. Lucie	FL	34986	(772) 345-9500
MANG, Kap Sian	1537 NW St. Lucie West Blvd.	Port St. Lucie	FL	34986	(772) 878-7393
OO, Naing Lin	2310 Tamiami Trl Unit 1129	Punta Gorda	FL	33950-5933	(941) 575-4740
OO, Naing Lin	2310 Tamiami Trl Unit 1129	Punta Gorda	FL	33950-5933	(941) 575-4740
MAUNG, Eric Julian	3941 Tamiami Trail	Punta Gorda	FL	33950	(941) 575-0793
LUAI, Thang Hre	11667 Boyette Rd.	Riverview	FL	33569	(813) 672-4353
KIMA, Biak Tha	11109 Winthrop Market Street	Riverview	FL	33578	(813) 661-3286
PHOME, Mark	13154 U.S. Hwy 301 S.	Riverview	FL	33578	(813) 741-0693
ROBIN, Con Lianbik	3863 US Hwy 301 S.	Riverview	FL	33578	(813) 626-7104
PHOME, Mark	13154 U.S. Hwy 301 S.	Riverview	FL	33578	(813) 741-0693
LUAI, Thang Hre	11667 Boyette Rd.	Riverview	FL	33569	(813) 672-4353
TUANG, Thang Sawm	5380 Stadium Pkwy.	Rockledge	FL	32955	(321) 433-0936
TUANG, Thang Sawm	5380 Stadium Pkwy.	Rockledge	FL	32955	(321) 433-0936
OO, Khin Nwe	4255 US 1 South	Saint Augustine	FL	32086	(904) 797-1111
TIN, Saw Darbu	7462 US Highway 1 North	Saint Augustine	FL	32095	(904) 826-3537
SOUVANNASOTH, Pom	170 Village Commons Drive	Saint Augustine	FL	32092	(904) 940-3357
HTIKE, Tun Nanda	250 Plaza Boulevard	Saint Augustine	FL	32086	(904) 808-9923
THANG, Sui Bik	155 Bartram Market Drive	Saint Johns	FL	32259	(904) 260-6565
CUNG, Ting Peng	835 CR 210 W	Saint Johns	FL	32259	(904) 824-3334
SUUN, Dongh Kheen	3700 4th St. N	Saint Petersburg	FL	33704	(727) 526-3019
SUUN, Dongh Kheen	3700 4th St. N	Saint Petersburg	FL	33704	(727) 526-3019
SUM, Khup Sai	5240 West SR 46	Sanford	FL	32771	(407) 321-0423
TOHING, Kam Khan Kim	110 Water color way	Santa Rosa Beach	FL	32459	(850) 534-4565
TOHING, Kam Khan Kim	110 Water color way	Santa Rosa Beach	FL	32459	(850) 534-4565
TOHING, Kam Khan Kim	110 Water color way	Santa Rosa Beach	FL	32459	(850) 534-4565
LIN, Zaw Bo Bo	5391 Fruitville Rd	Sarasota	FL	34232	(941) 377-4405
LINH TUN, James	8409 S. Tamiami Trail	Sarasota	FL	34238	(941) 925-4778
MYINT, Zarchi M	3825 S. Osprey Ave.	Sarasota	FL	34239	(941) 316-0616
LIN, Zaw Bo Bo	5391 Fruitville Rd	Sarasota	FL	34232	(941) 377-4405
HA, Sai Thi	2875 University Pkwy	Sarasota	FL	34243	(941) 358-1169
KHUA HLUE, T.	1044 N. Tamiami Trail	Sarasota	FL	34236-2428	(941) 366-3270
MYINT, Zarchi M	3825 S. Osprey Ave.	Sarasota	FL	34239	(941) 316-0616
KHUA HLUE, T.	1044 N. Tamiami Trail	Sarasota	FL	34236-2428	(941) 366-3270
SWE, Thet Hta	3428 Clark Rd.	Sarasota	FL	34231	(941) 921-3766
AYE, Than Nyunt	501 N. Beneva Rd.	Sarasota	FL	34237	(941) 330-9771
MYINT, Zarchi M	3825 S. Osprey Ave.	Sarasota	FL	34239	(941) 316-0616
HA, Sai Thi	2875 University Pkwy	Sarasota	FL	34243	(941) 358-1169
HA, Sai Thi	2875 University Pkwy	Sarasota	FL	34243	(941) 358-1169
HA, Sai Thi	2875 University Pkwy	Sarasota	FL	34243	(941) 358-1169
MUNG, Suan Khen	270 E. Eau Gallie Blvd.	Satellite Beach	FL	32937	(321) 773-2915
TUANG, Hau	4703 N. Ocean Dr.	Sea Ranch Lakes	FL	33308	(954) 784-3707
KIM, Thang Za	13435 U.S Highway 1	Sebastian	FL	32958	(772) 589-5110
KIM, Thang Za	13435 U.S Highway 1	Sebastian	FL	32958	(772) 589-5110
KIM, Thang Za	13435 U.S Highway 1	Sebastian	FL	32958	(772) 589-5110
PUM, Michael Lian Za	3610 US Highway 27 North	Sebring	FL	33870	(863) 385-2025
AUNG, Hein	2848 US 27 #107	Sebring	FL	33870	(863) 314-8746
AUNG, Hein	2848 US 27 #107	Sebring	FL	33870	(863) 314-8746
HRAM, Mang Nei	11782 E Dr MLK Jr Blvd	Seffner	FL	33584	(813) 684-6029
HRAM, Mang Nei	11782 E Dr MLK Jr Blvd	Seffner	FL	33584	(813) 684-6029
LIAN, Joshua Van	10801 Starkey Rd Ste. 200	Seminole	FL	33777	(727) 397-4223
OO, K Khine	9201 Oakhurst	Seminole	FL	33776	(727) 593-7794
LIANA, Zir S	7880 113th Street	Seminole	FL	33772	(727) 393-9680
LIANA, Zir S	7880 113th Street	Seminole	FL	33772	(727) 393-9680
OO, K Khine	9201 Oakhurst	Seminole	FL	33776	(727) 593-7794
OO, K Khine	9201 Oakhurst	Seminole	FL	33776	(727) 593-7794
SMITH, Paul	2400 S. Ridgewood	South Daytona	FL	32119	(386) 756-9969
TIN, Nyunt	4365 Commercial Way	Spring Hill	FL	34606	(352) 597-8500
BAT, Kawl	14371 Spring Hill Dr.	Spring Hill	FL	34609-8199	(352) 666-2000
ZAM, Hram Nei	4158 Mariner Blvd	Spring Hill	FL	34609	(352) 688-0161
BAT, Kawl	14371 Spring Hill Dr.	Spring Hill	FL	34609-8199	(352) 666-2000
SAY, Henry	125 Jenkins St.	St. Augustine	FL	32086	(904) 808-0514
SAY, Henry	125 Jenkins St.	St. Augustine	FL	32086	(904) 808-0514
MAW TANG, Lubu	84 Tuscan Way	St. Augustine	FL	32092	(904) 940-2889
SHARI, Sut Naw	955 State Road 16	St. Augustine	FL	32084	(904) 819-6518
SAN, Maw	4401 13th St.	St. Cloud	FL	34769	(407) 498-3070
SAN, Maw	4401 13th St.	St. Cloud	FL	34769	(407) 498-3070
NYUNT, Thida	3372 Canoe Creek Road	St. Cloud	FL	34772	(407) 957-8888
NYUNT, Thida	3372 Canoe Creek Road	St. Cloud	FL	34772	(407) 957-8888
MIN, Pyae Phyo	205 Rivertown Shops Drive	St. Johns	FL	32259	(904) 230-1347

Zenshi Food Service Counters

Franchise List

As of March 31, 2025

Franchisee Name	Address	City	State	Zip	Phone
KHUP, Vincent Sai	250 3rd St. South	St. Petersburg	FL	33701	(727) 822-1125
MAWI, Mary Zung Rem	120 Carillon Pkwy	St. Petersburg	FL	33716	(727) 540-1660
KHUP, Vincent Sai	250 3rd St. South	St. Petersburg	FL	33701	(727) 822-1125
CHUM, Than	10496 Roosevelt Blvd.N	St. Petersburg	FL	33716	(727) 576-5858
GYI, Khin Maung	200 37th Ave. N	St. Petersburg	FL	33704	(727) 895-1670
GABYAR, Lamin	7999 Martin Luther King Blvd	St. Petersburg	FL	33702	(727) 578-2833
SUM, Pau Khan	1600 66th Street North	St. Petersburg	FL	33710	(727) 344-1216
MANG, Lal Hrin	3030 54th Ave S.	St. Petersburg	FL	33712	(727) 864-2030
CHUM, Than	10496 Roosevelt Blvd.N	St. Petersburg	FL	33716	(727) 576-5858
MANG, Lal Hrin	3030 54th Ave S.	St. Petersburg	FL	33712	(727) 864-2030
KAI, Kap Hlei	4655 Gulf Blvd.	St. Petersburg Beach	FL	33706	(727) 360-7091
KAI, Kap Hlei	4655 Gulf Blvd.	St. Petersburg Beach	FL	33706	(727) 360-7091
KHAI, Ngin Khawm	940 NE Ocean Blvd	Stuart	FL	34996	(772) 334-0578
TUTTLE, Orathai	746 S. Federal Hwy	Stuart	FL	34994	(772) 221-3922
MUNG, Thang Suan	6550 S. Kanner Hwy	Stuart	FL	34997	(772) 221-8135
KAWAMURA, Renato Akio	1501 NW Federal Hwy	Stuart	FL	34994	(772) 692-5025
KAWAMURA, Renato Akio	1501 NW Federal Hwy	Stuart	FL	34994	(772) 692-5025
KHAI, Ngin Khawm	940 NE Ocean Blvd	Stuart	FL	34996	(772) 334-0578
KHAI, Ngin Khawm	940 NE Ocean Blvd	Stuart	FL	34996	(772) 334-0578
THANG, Za Biak	4854 Sun City Center Blvd	Sun City Center	FL	33573	(813) 633-3440
THANG, Za Biak	4854 Sun City Center Blvd	Sun City Center	FL	33573	(813) 633-3440
MAR, Thi Thi	18330 Collins Avenue	Sunny Isles Beach	FL	33160	(305) 935-1556
MANG, Thang Sawm	10155 W. Oakland Park Blvd.	Sunrise	FL	33351	(954) 748-5300
MANG, Thang Sawm	10155 W. Oakland Park Blvd.	Sunrise	FL	33351	(954) 748-5300
LANG, Nang Do	9400 Harding Ave.	Surfside	FL	33154	(305) 865-1263
MUNG, Khen Lian	6753 Thomasville Rd	Tallahassee	FL	32312	(850) 668-5702
GO, Vungh Kap	5032 Capital Circle S.W	Tallahassee	FL	32305	(850) 878-1133
KHAI, Dal Sawm	800 Ocala Rd	Tallahassee	FL	32304	(850) 575-3929
SIE, S. Be	1700 N Monroe St.	Tallahassee	FL	32303	(850) 222-1975
GREGORIO, Kaw Kaw	6615 Mahan Dr.	Tallahassee	FL	32308	(850) 878-4899
GO, Vungh Kap	5032 Capital Circle S.W	Tallahassee	FL	32305	(850) 878-1133
GO, Vungh Kap	5032 Capital Circle S.W	Tallahassee	FL	32305	(850) 878-1133
OO, Htun Ni	3521 Thomasville Rd	Tallahassee	FL	32309-7134	(850) 893-0137
GREGORIO, Kaw Kaw	6615 Mahan Dr.	Tallahassee	FL	32308	(850) 878-4899
LAHTAW, GUM SENG	2111 NE Capital Circle	Tallahassee	FL	32308	(850) 523-9851
MUNG, Khen Lian	6753 Thomasville Rd	Tallahassee	FL	32312	(850) 668-5702
KAM, Thang Deih	625 W. Gaines St.	Tallahassee	FL	32301	(850) 577-1915
THUREIN, Tun	5678 Capital Circle NW	Tallahassee	FL	32303	(850) 562-0088
LAHTAW, GUM SENG	2111 NE Capital Circle	Tallahassee	FL	32308	(850) 523-9851
KAP, Gin Cin	8245 N.W. 88th Ave	Tamarac	FL	33321	(954) 726-1990
LUN, Hau Za	5881 N. University Dr.	Tamarac	FL	33321	(954) 721-7800
KAP, Gin Cin	8245 N.W. 88th Ave	Tamarac	FL	33321	(954) 726-1990
LUN, Hau Za	5881 N. University Dr.	Tamarac	FL	33321	(954) 721-7800
LWIN, Aung Soe	2908 N. Boundary Blvd.	Tampa	FL	33621	(813) 828-3361
THEIN, Ni Ni	15151 N. Dale Mabry Hwy	Tampa	FL	33618	(813) 265-3288
BIAK, Ma	7018 W. Waters Ave	Tampa	FL	33634	(813) 884-3764
FUNG, Mary	6001 N Nebraska Ave	Tampa	FL	33604	(813) 238-7720
THANG, Za Ni	2724 W Hillsborough Ave.	Tampa	FL	33614-6053	(813) 673-8900
THUAI, Cecilia Ngun Hle	19034 Bruce B. Downs Blvd.	Tampa	FL	33647	(813) 631-1911
LEONG, Richard Kyi Sein	1313 S. Dale Mabry Hwy.	Tampa	FL	33629	(813) 258-9801
TIN, Garrett San-Thein	12139 West Linebaugh Ave.	Tampa	FL	33626	(813) 814-0737
LEONG, Richard Kyi Sein	1313 S. Dale Mabry Hwy.	Tampa	FL	33629	(813) 258-9801
OO, Myo Myea	7835 Gunn Hwy	Tampa	FL	33626	(813) 926-6664
PAR, Van Nei Sui	10015 N. Dale Mabry Hwy	Tampa	FL	33618-4409	(813) 961-0075
THANG, Lal	10928 Cross Creek Blvd	Tampa	FL	33647	(813) 986-1239
THANG, Lal	10928 Cross Creek Blvd	Tampa	FL	33647	(813) 986-1239
MAWI, Sarah	5371 Ehrlich Road	Tampa	FL	33625	(813) 265-2372
LEONG, Sarah L	2403 West Azeele Street	Tampa	FL	33609	(813) 250-0129
RUANG, Tial N.	8701 West Hillsborough Avenue	Tampa	FL	33615	(727) 785-7473
TIN, Garrett San-Thein	12139 West Linebaugh Ave.	Tampa	FL	33626	(813) 814-0737
SIN, Mawi Eng	16041 Tampa Palms Blvd West	Tampa	FL	33647-2001	(813) 972-2784
THANG, Za Ni	2724 W Hillsborough Ave.	Tampa	FL	33614-6053	(813) 673-8900
THANG, Lal	10928 Cross Creek Blvd	Tampa	FL	33647	(813) 986-1239
MYINT, Ohn	3838 Britton Plaza	Tampa	FL	33611	(813) 835-1280
SUI, Mai Bawi	12024 Anderson Rd.	Tampa	FL	33625	(813) 264-4457
LEONG, Sarah L	2403 West Azeele Street	Tampa	FL	33609	(813) 250-0129
ZAW, Yaw	4425 East Fletcher Ave.	Tampa	FL	33613	(813) 631-1269
LEONG, Sarah L	2403 West Azeele Street	Tampa	FL	33609	(813) 250-0129
LEONG, Richard Kyi Sein	1313 S. Dale Mabry Hwy.	Tampa	FL	33629	(813) 258-9801
MYINT, Ohn	3838 Britton Plaza	Tampa	FL	33611	(813) 835-1280
THUAI, Cecilia Ngun Hle	19034 Bruce B. Downs Blvd.	Tampa	FL	33647	(813) 631-1911

Zenshi Food Service Counters

Franchise List

As of March 31, 2025

Franchisee Name	Address	City	State	Zip	Phone
MYINT, Ohn	3838 Britton Plaza	Tampa	FL	33611	(813) 835-1280
SWEET, Melody Suilenmawi	40932 US HWY 19 North	Tarpon Springs	FL	34689	(727) 934-6535
PIANG, Dal Khan	2042 State Road 19	Tavares	FL	32778	(352) 742-2439
SUI, Dawt Nei	5450 E Busch Blvd	Temple Terrace	FL	33617	(813) 984-6411
OO, Myint Lwin	11502 N 53rd St.	Temple Terrace	FL	33617	(813) 914-7252
SANG, Pau	8780 SE 165th Mulberry Ln	The Villages	FL	32162	(352) 751-0301
DAM, Thang Cin	3475 Wedgewood Ln.	The Villages	FL	32162-7183	(352) 751-6280
KO, Myat	327 Colony Blvd	The Villages	FL	32162	(352) 391-1802
THAWNG, Timothy Cung Lian	2925 Traverse Trail	The Villages	FL	32163	(352) 751-6280
THAWNG, Timothy Cung Lian	2925 Traverse Trail	The Villages	FL	32163	(352) 751-6280
KO, Myat	327 Colony Blvd	The Villages	FL	32162	(352) 391-1802
SUNG, Pum Dik	2135 Everglades Lane	The Villages	FL	32163	(352) 461-5096
CIN, Thang L	3275 Garden Street	Titusville	FL	32796-3004	(321) 264-9263
LIAN, Thang Rih	3461 Lithia Pinecrest Rd.	Valrico	FL	33596	(813) 661-4283
LIAN, Thang Rih	3461 Lithia Pinecrest Rd.	Valrico	FL	33596	(813) 661-4283
DANIEL, Thomas	535 Tamiami Trl S	Venice	FL	34285	(941) 484-3346
DANIEL, Thomas	535 Tamiami Trl S	Venice	FL	34285	(941) 484-3346
SAW, Tnar	1255 US Highway 1	Vero Beach	FL	32960	(772) 778-1984
HAN, Moe Hein	2040 58th Ave.	Vero Beach	FL	32966	(772) 569-1204
SAW, Tnar	1255 US Highway 1	Vero Beach	FL	32960	(772) 778-1984
SAUNG, Sai	4145 9th St. SW.	Vero Beach	FL	32968	(772) 299-6235
SAW, Tnar	1255 US Highway 1	Vero Beach	FL	32960	(772) 778-1984
HAN, Moe Hein	2040 58th Ave.	Vero Beach	FL	32966	(772) 569-1204
SUNG, Van Nei	9595 Commercial Way	Weeki Wachee	FL	34613	(352) 596-5081
MUNG, Go Sian	11950 West Forest Hill Blvd	Wellington	FL	33414	(561) 422-9640
KIM, Nuam Khawm	13880 WELLINGTON TRACE	WELLINGTON	FL	33414	(561) 795-8555
THANG, Israel Sui Hlei	1920 County Rd 581	Wesley Chapel	FL	33543	(813) 994-4566
THANG, Thawng V.	5400 Bruce B. Downs Blvd	Wesley Chapel	FL	33544	(813) 907-1699
YUNG, Lun Cing	145 Palm Bay Rd NE	West Melbourne	FL	32904	(321) 722-0022
SANG, Khup Khan	1500 SW 57th Ave	West Miami	FL	33144	(305) 265-8019
MYINT, Maung Maung	828 Southern Blvd.	West Palm Beach	FL	33405	(561) 832-1661
HAN, Nilar Win	2895 N Military Trl	West Palm Beach	FL	33409	(561) 687-0445
CIN, Khup Kaih	10130 Northlake Blvd.	West Palm Beach	FL	33412	(561) 799-6802
MUNG, Kap Zo	8989 Okeechobee Blvd	West Palm Beach	FL	33411	(561) 792-2113
SOPHAMISAY, Chansouk	4075 North Haverhill Rd	West Palm Beach	FL	33417	(561) 683-0412
PAU, Zam Suan	375 S. Rosemary	West Palm Beach	FL	33401	(561) 651-7787
HAN, Nilar Win	2895 N Military Trl	West Palm Beach	FL	33409	(561) 687-0445
MEKPISAN, Nachapon	6820 Okeechobee Blvd.	West Palm Beach	FL	33411	(561) 682-3015
PAU, Zam Suan	375 S. Rosemary	West Palm Beach	FL	33401	(561) 651-7787
HAN, Nilar Win	2895 N Military Trl	West Palm Beach	FL	33409	(561) 687-0445
OO, Maung Nay	831 Village Blvd	West Palm Beach	FL	33409	(561) 615-6808
OO, Maung Nay	831 Village Blvd	West Palm Beach	FL	33409	(561) 615-6808
MYINT, Maung Maung	828 Southern Blvd.	West Palm Beach	FL	33405	(561) 832-1661
MUNG, Kap Zo	8989 Okeechobee Blvd	West Palm Beach	FL	33411	(561) 792-2113
KIM, Thang	2465 Glades Circle	Weston	FL	33327	(954) 217-0022
KIM, Thang	2465 Glades Circle	Weston	FL	33327	(954) 217-0022
CIN, In Za	294 Indian Trace Rd	Weston	FL	33326	(954) 384-4190
THU, May	1601 Promenade Blvd	Weston	FL	33326	(954) 660-0322
DINLIANA, Su Ieie Maung	4567 Weston Rd	Weston	FL	33331	(954) 217-1195
THU, May	1601 Promenade Blvd	Weston	FL	33326	(954) 660-0322
RING, Tsin Pan	100 W. Oakland Park Blvd	Wilton Manors	FL	33311	(954) 565-4891
KHAI, Hau Sian	2633 N Dixie Highway	Wilton Manors	FL	33334	(954) 561-8531
RING, Tsin Pan	100 W. Oakland Park Blvd	Wilton Manors	FL	33311	(954) 565-4891
KHAI, Hau Sian	2633 N Dixie Highway	Wilton Manors	FL	33334	(954) 561-8531
SUAKA, Somkhid	14323 S. US Highway 301	Wimauma	FL	33598	(813) 634-2117
WONG, Ban Seong	13450 Summerport Village	Windermere	FL	34786	(407) 905-0199
HUANG, Steven	7880 Winter Garden Vineland Rd	Windermere	FL	34786	(407) 876-0605
NGUYEN, Joseph Ah Hong	13750 W. Colonial Drive	Winter Garden	FL	34787	(407) 654-7172
HTWE, Tin	15508 Stoneybrook W. Pkwy	Winter Garden	FL	34787	(407) 654-6404
KELLEY, Rattana	5400 Hamlin Groves Trail	Winter Garden	FL	34787	(407) 654-6157
TRIYONO, Winarti	10650 Avalon Rd	Winter Garden	FL	34787	(407) 550-9012
PAIHSAWH, Van Bawi Luai	1090 Spirit Lake Rd.	Winter Haven	FL	33880	(863) 293-3804
HATLANG, Gin Lamtuang	1395 6th St. NW.	Winter Haven	FL	33881	(863) 299-8000
PAIHSAWH, Van Bawi Luai	1090 Spirit Lake Rd.	Winter Haven	FL	33880	(863) 293-3804
PHAIPI, Donald	884 Cypress Gardens Blvd SE	Winter Haven	FL	33880	(863) 291-0312
KHAI, Thang Kim	2295 Aloma Ave.	Winter Park	FL	32792-3303	(407) 671-3403
MANG, Thang Ai	4000 North Goldenrod Road	Winter Park	FL	32792-8999	(407) 671-0211
CING, Man Dim	741 S. Orlando Ave.	Winter Park	FL	32789	(407) 622-0302
MUNG, Kap Tung	1160 E State Road 434	Winter Springs	FL	32708	(407) 327-9725
MUNG, Kap Tung	1160 E State Road 434	Winter Springs	FL	32708	(407) 327-9725
MAWI, Sui Dim	463855 State Rd 200	Yulee	FL	32097	(904) 261-2400

Zenshi Food Service Counters

Franchise List

As of March 31, 2025

Franchisee Name	Address	City	State	Zip	Phone
MAWI, Sui Dim	463855 State Rd 200	Yulee	FL	32097	(904) 261-2400
LUAI, Sa Tin	76010 William Burgess Blvd	Yulee	FL	32097	(800) 242-1227
THANG, Cung Nai	32765 Eiland Boulevard	Zephyrhills	FL	33545	(813) 779-2368
SANG, Van Lawm	7838 Gall Blvd	Zephyrhills	FL	33541	(813) 783-6871
THANG, Cung Nai	32765 Eiland Boulevard	Zephyrhills	FL	33545	(813) 779-2368
TOM, Venta	1720 Mars Hill Road	Acworth	GA	30101	(770) 419-5490
TOM, Venta	1720 Mars Hill Road	Acworth	GA	30101	(770) 419-5490
SANG, Biak Awi	3507 Baker Rd. N.W.	Acworth	GA	30101	(770) 917-4600
SANG, Biak Awi	3507 Baker Rd. N.W.	Acworth	GA	30101	(770) 917-4600
THANG, Lang Za	2715 Dawson Rd	Albany	GA	31707	(229) 431-2880
DING, Shuyue	10945 State Bridge Rd.	Alpharetta	GA	30022	(770) 751-3000
YU, Qinguo	12460 Crabapple Rd.	Alpharetta	GA	30004	(770) 740-2050
CUNG, Van Tha	5665 GA HWY. 9	Alpharetta	GA	30004	(770) 752-5380
CHEN, Xiuchai	11895 Douglas Rd	Alpharetta	GA	30005	(770) 751-3110
THANG, Van Lian	12870 Highway 9 N	Alpharetta	GA	30004	(770) 772-3699
LEE, Sabrina	8465 Holcomb Bridge Rd.	Alpharetta	GA	30022	(770) 650-1000
AUNG, Thiri Pann War	9925 Haynes Bridge Rd	Alpharetta	GA	30022	(770) 751-7980
AUNG, Thiri Pann War	9925 Haynes Bridge Rd	Alpharetta	GA	30022	(770) 751-7980
ZHOU, Guoping	4900 Atlanta Hwy	Alpharetta	GA	30004	(770) 754-4321
AUNG, Thiri Pann War	9925 Haynes Bridge Rd	Alpharetta	GA	30022	(770) 751-7980
PIANG, Cinthan	270 Rucker Rd	Alpharetta	GA	30004	(770) 360-5591
PIANG, Cinthan	270 Rucker Rd	Alpharetta	GA	30004	(770) 360-5591
LIAN, Steven	5180 McGinnis Ferry Rd.	Alpharetta	GA	30005	(770) 360-1025
AUNG, Myou Koko	3000 Old Alabama Rd.	Alpharetta	GA	30022	(770) 751-7384
THANG, Zaw Hein	2301 College Station Road	Athens	GA	30605	(706) 353-8543
LIM, Ji-Hyun	191 Alps Road	Athens	GA	30606	(706) 543-0209
DING, Ze	1720 Epps Bridge Road	Athens	GA	30606	(706) 583-8900
PU, Peter Mang	700 US Highway 29N	Athens	GA	30601	(770) 496-5382
MANG, Hau Lian	3620 Atlanta Hwy	Athens	GA	30606	(706) 208-3700
TUN, Zar Ni Mya	1860 Barnett Shoals Rd.	Athens	GA	30605-6811	(706) 227-6260
MANG, Hau Lian	3620 Atlanta Hwy	Athens	GA	30606	(706) 208-3700
YANG, Leila	1700 Monroe Dr.	Atlanta	GA	30324	(404) 872-0782
KHEN, Tial	2205 Lavista Road	Atlanta	GA	30329	(404) 633-8694
CHEN, Liyu	2090 Dunwoody Club Drive	Atlanta	GA	30350	(770) 391-9035
TUANG, Tin Lian	1715 Howell Mill Rd.	Atlanta	GA	30318	(404) 355-7886
CING, Ngai Hei Nuam	4920 Roswell Road	Atlanta	GA	30342	(404) 843-3080
TUANG, Tin Lian	1715 Howell Mill Rd.	Atlanta	GA	30318	(404) 355-7886
THANG, Ceu Lian	590 Cascade Rd	Atlanta	GA	30310	(404) 756-1140
LIAN, Thang Cin	1225 Caroline Street	Atlanta	GA	30307	(404) 880-4105
THANG, Cung Bawi	3030 Headland Drive SW	Atlanta	GA	30311	(404) 344-0177
LI, Men	3425 Cascade Road	Atlanta	GA	30311	(404) 505-8855
THANG, Cung Bawi	3030 Headland Drive SW	Atlanta	GA	30311	(404) 344-0177
LIN, Xiuduan	3871 Peachtree Rd NE	Atlanta	GA	30319	(404) 240-0808
KHAI, Kham Sian	2542 Morosgo Way	Atlanta	GA	30324	(404) 946-0438
MANG, Tual Khan	800 Glenwood Ave SE	Atlanta	GA	30316	(470) 447-5030
MANG, Tual Khan	800 Glenwood Ave SE	Atlanta	GA	30316	(470) 447-5030
THANG, Cung Bawi	3030 Headland Drive SW	Atlanta	GA	30311	(404) 344-0177
THA, Dawt Hlei Zing	2235 Glenwood Ave.	Atlanta	GA	30316	(404) 373-2858
TUN, Tin Aung	2900 Peachtree Rd NW	Atlanta	GA	30305	(404) 848-0330
SUNG, Van	3695 Cascade Rd SW	Atlanta	GA	30331	(404) 505-2870
SUNG, Men	8725 Roswell Rd. Ste. G	Atlanta	GA	30350	(770) 640-5950
THANG, Tluang Za	6300 Powers Ferry Rd NW	Atlanta	GA	30339	(770) 612-5140
MANG, Tin Tian	1544 Piedmont Ave	Atlanta	GA	30324	(404) 898-1850
DIM, Neam Khan	3435 Ashford Dunwoody Rd NE	Atlanta	GA	30319	(770) 216-5050
MOE, Moe	7525 Roswell Road	Atlanta	GA	30350	(678) 443-8980
KHAR, Ngun	1100 Hammond Dr.	Atlanta	GA	30328	(678) 443-2100
CUNG, Dawt	3535 Peachtree Rd	Atlanta	GA	30326	(404) 848-0344
CEU, Biak Lian	4279 Roswell Road	Atlanta	GA	30342	(404) 843-4353
AN, Huayu	2365 Peachtree Rd NE	Atlanta	GA	30305	(404) 869-6556
CEU, Biak Lian	4279 Roswell Road	Atlanta	GA	30342	(404) 843-4353
HTOO, Hsa Ler	1001 Ponce De Leon	Atlanta	GA	30306	(404) 892-9229
DIM, Neam Khan	3435 Ashford Dunwoody Rd NE	Atlanta	GA	30319	(770) 216-5050
PARK, Brian	595 Piedmont Ave NE	Atlanta	GA	30308	(404) 881-1750
THA, Dawt Hlei Zing	2235 Glenwood Ave.	Atlanta	GA	30316	(404) 373-2858
LIAN, KAM NGAIH	2562 Shallowford Rd. NE	Atlanta	GA	30345	(404) 636-1175
ZA LIAN BAWI, Donbosco	1380 Atlantic Dr. NW	Atlanta	GA	30363	(404) 873-5055
SONG, Huo Jiao	2325 Cheshire Bridge Rd. NE	Atlanta	GA	30324-3725	(404) 638-1900
AN, Yang H	3730 Carmia Dr. S.W.	Atlanta	GA	30331	(404) 346-9253
HRANG, Chan	950 West Peachtree Street	Atlanta	GA	30309	(404) 253-3544
DIM, Neam Khan	3435 Ashford Dunwoody Rd NE	Atlanta	GA	30319	(770) 216-5050
MOE, Moe	7525 Roswell Road	Atlanta	GA	30350	(678) 443-8980

Zenshi Food Service Counters

Franchise List

As of March 31, 2025

Franchisee Name	Address	City	State	Zip	Phone
LIAN, KAM NGAIH	2562 Shallowford Rd. NE	Atlanta	GA	30345	(404) 636-1175
DIM, Neam Khan	3435 Ashford Dunwoody Rd NE	Atlanta	GA	30319	(770) 216-5050
CING, Hau Lam	905 Memorial Drive SE	Atlanta	GA	30316	(404) 521-3992
LIAN, Thang Cin	1225 Caroline Street	Atlanta	GA	30307	(404) 880-4105
VUNG, Ning Khan	572 Hank Aaron Drive S.E.	Atlanta	GA	30315	(800) 242-1227
CING, Hau Lam	905 Memorial Drive SE	Atlanta	GA	30316	(404) 521-3992
VUNG, Ning Khan	572 Hank Aaron Drive S.E.	Atlanta	GA	30315	(800) 242-1227
E SANG ENTERPRISES, INC.	2451 Cumberland Pkwy SE	Atlanta	GA	30339	(770) 437-7000
THANG, Lei Hmun	2907 Washington Road	Augusta	GA	30909	(757) 389-3805
NUAM, Cing Deih	3942 Harper Franklin Ave	Augusta	GA	30909	(706) 261-5201
MANG, Van Biak	2801 Washington Road	Augusta	GA	30909	(706) 731-7300
KHAI, Nang Mun	2816 Washington Rd	Augusta	GA	30909	(706) 731-5200
PUM, Lang Suan	171 Village At Glynn Pl	Brunswick	GA	31525	(912) 261-4730
XU, Fan	5885 Cumming Hwy	Buford	GA	30518-5765	(770) 614-8860
LIN, Dong	4840 Golden Parkway	Buford	GA	30518	(770) 614-7700
Chen, Chunyan	4108 Hamilton Mill Rd.	Buford	GA	30519	(770) 831-1054
KHAI, Do Khan	4045 Marietta Hwy	Canton	GA	30114	(770) 345-3644
CIN, Pau Lam	8020 Cumming Hwy	Canton	GA	30115	(770) 345-8451
NG, Kim H	6766 Hickory Flat Hwy	Canton	GA	30115	(770) 721-7300
MAWNG, Te	12424 Cumming Hwy	Canton	GA	30115	(678) 455-0112
MAWNG, Te	12424 Cumming Hwy	Canton	GA	30115	(678) 455-0112
CIN, Pau Lam	8020 Cumming Hwy	Canton	GA	30115	(770) 345-8451
SANG, Van Biak	1355 South Park Street	Carrollton	GA	30117	(770) 832-8932
KHINE, Hnin Nu Nu	1109 S Park St. Ste #600	Carrollton	GA	30117	(770) 214-3140
LIN, Deng Ming	125 MAIN STREET MARKET PL SE	Cartersville	GA	30121	(770) 386-8102
KYAW, Sai M.	300 Cherokee Place	Cartersville	GA	30121	(770) 606-2360
KYAW, Sai M.	300 Cherokee Place	Cartersville	GA	30121	(770) 606-2360
KYAW, Sai M.	300 Cherokee Place	Cartersville	GA	30121	(770) 606-2360
KYAW, Sai M.	300 Cherokee Place	Cartersville	GA	30121	(770) 606-2360
MAWI, Siang Za	5534 Peachtree Blvd	Chamblee	GA	30341	(770) 457-9835
SUNG, Biak Li	1639 Bradley Park Dr. Ste 600	Columbus	GA	31904	(706) 571-3420
SOE, Ye Myint	5435 Woodruff Farm Rd	Columbus	GA	31907	(706) 568-8820
RUL, Pa	7600 SCHOMBURG ROAD	COLUMBUS	GA	31909	(706) 565-3260
THURMI, Van Van	3201 Macon Road	Columbus	GA	31906-1717	(706) 561-2160
LIAN, Lian	6901 RAY WRIGHT BLVD.	COLUMBUS	GA	31820	(706) 358-0289
Kip, Thawng	8132 VETERANS PKWY	COLUMBUS	GA	31909	(706) 223-6574
KIM, Maung Suan	1745 GA-138 SE	Conyers	GA	30013	(770) 922-8753
KIM, Maung Suan	1745 GA-138 SE	Conyers	GA	30013	(770) 922-8753
TA, Khual	1591 Georgia Highway 20 NE	Conyers	GA	30012-3834	(678) 413-2421
TIN, Thang Lam	3139 US Highway 278 NE	Covington	GA	30014	(770) 787-0724
TIN, Thang Lam	3139 US Highway 278 NE	Covington	GA	30014	(770) 787-0724
LIN, Jasper	3700 Salem Rd.	Covington	GA	30016	(678) 342-6039
NO, En	43001 Town Center Dr.	Covington	GA	30014	(770) 385-5705
MUNG, Zam Mun	2325 BETHELVIEW RD	CUMMING	GA	30040	(770) 888-1020
MUNG, Zam Mun	2325 BETHELVIEW RD	CUMMING	GA	30040	(770) 888-1020
LI, Yalin	1595 Peachtree Parkway	Cumming	GA	30041	(678) 455-4580
LI, Yalin	1595 Peachtree Parkway	Cumming	GA	30041	(678) 455-4580
YONG, Pui Yee	5550 Bethelview Road	Cumming	GA	30040	(770) 888-1020
CHEN, Hao En	1735 Buford Hwy	Cumming	GA	30041-1266	(770) 781-5601
CAN, Dar	3480 Keith Bridge Rd	Cumming	GA	30041-5546	(678) 455-0610
CHEN, Hao En	1735 Buford Hwy	Cumming	GA	30041-1266	(770) 781-5601
TIAL, Siang	580 Atlanta Rd.	Cumming	GA	30040	(770) 781-2040
WU, Rina	5475 Bethelview Rd.	Cumming	GA	30040	(678) 455-1232
TIAL, Siang	580 Atlanta Rd.	Cumming	GA	30040	(770) 781-2040
DONG, Jingya	5310 Matt Highway	Cumming	GA	30028	(770) 889-5778
TLIR, Rai Than	2700 Brazelton Highway	Dacula	GA	30019	(770) 614-1020
CHOI, Christine	2463 Hamilton Mill Parkway	Dacula	GA	30019	(770) 614-1070
MUNG, Thang Sian	455 Nathan Dean Blvd	Dallas	GA	30132	(770) 443-0811
MUNG, Thang Sian	455 Nathan Dean Blvd	Dallas	GA	30132	(770) 443-0811
THANG, Chan Mawi	51 E. Paulding Dr.	Dallas	GA	30157	(770) 505-5838
THANG, Chan Mawi	51 E. Paulding Dr.	Dallas	GA	30157	(770) 505-5838
THANG, Chan Mawi	51 E. Paulding Dr.	Dallas	GA	30157	(770) 505-5838
HRANG LUNG, Sui Tin Hnem	7953 Villa Rica Hwy	Dallas	GA	30157	(678) 840-4676
MUNG, Thang Sian	455 Nathan Dean Blvd	Dallas	GA	30132	(770) 443-0811
ZAR, Khun Nay	1365 W. Walnut Ave.	Dalton	GA	30720	(706) 270-0843
CHEN, Dezhui	378 Marketplace Parkway	Dawsonville	GA	30534	(800) 576-4377
SUNG, Tha Hlei	145 Forest Blvd. Suite 100	Dawsonville	GA	30534	(706) 216-4220
SUNG, Tha Hlei	145 Forest Blvd. Suite 100	Dawsonville	GA	30534	(706) 216-4220
NIANG, MAN LUN	4919 Flat Shoals Pkwy	Decatur	GA	30034	(770) 322-8984
SANG, Ni Luai	3870 N. Druid Hills Rd	Decatur	GA	30033	(404) 638-1293
SANG, Ni Luai	3870 N. Druid Hills Rd	Decatur	GA	30033	(404) 638-1293

Zenshi Food Service Counters

Franchise List

As of March 31, 2025

Franchisee Name	Address	City	State	Zip	Phone
SANG, Ni Lui	3870 N. Druid Hills Rd	Decatur	GA	30033	(404) 638-1293
CING, Ning Sian	2720 E Ponce de Leon Ave	Decatur	GA	30030	(404) 378-9225
MANG, Thang En	3479 Memorial Drive	Decatur	GA	30032	(404) 286-5780
MANG, Thang En	3479 Memorial Drive	Decatur	GA	30032	(404) 286-5780
CING, Lian San	1329 S. PETERSON AVE	DOUGLAS	GA	31533	(912) 493-6059
LIAN, Ceu Cin	3251 Highway 5	Douglasville	GA	30135	(770) 920-1880
LIAN, Ceu Cin	3251 Highway 5	Douglasville	GA	30135	(770) 920-1880
LIAN, Ceu Cin	3251 Highway 5	Douglasville	GA	30135	(770) 920-1880
PAR, Ngun Neih	3875 Chapel Hill Road	Douglasville	GA	30135	(770) 947-7144
LIAN, Peter Pau Hau	4815 Ridge Rd	Douglasville	GA	30134	(770) 949-2661
TUN, Nang Sian	3316 Highway 5	Douglasville	GA	30135	(770) 920-3460
TUN, Nang Sian	3316 Highway 5	Douglasville	GA	30135	(770) 920-3460
NAI LIAN, Abraham	1100 Hillcrest Pkwy	Dublin	GA	31021	(478) 277-3081
XU, Mingzhu	3455 Peachtree Industrial Blvd.	Duluth	GA	30096	(770) 476-7914
WU, Yinggang	6555 Sugarloaf Parkway	Duluth	GA	30097	(770) 814-7190
XU, Mingzhu	3455 Peachtree Industrial Blvd.	Duluth	GA	30096	(770) 476-7914
LIN, Shao Peng	3093 Steve Reynolds Blvd.	Duluth	GA	30096	(770) 921-4579
FRAZIER, Chunbo	5805 State Bridge Rd.	Duluth	GA	30097	(770) 813-7450
LEE, Kyubong	1625 Pleasant Hill Rd	Duluth	GA	30096	(770) 806-2780
CHUAH, Van San	2750 Buford Hwy	Duluth	GA	30096	(770) 622-6750
LEE, Kyubong	1625 Pleasant Hill Rd	Duluth	GA	30096	(770) 806-2780
CHUAH, Van San	2750 Buford Hwy	Duluth	GA	30096	(770) 622-6750
ZHANG, Yuanhui	4498 Chamblee Dunwoody Rd.	Dunwoody	GA	30338	(770) 451-8350
THE, Ei Ei	5550 Chamblee Dunwoody	Dunwoody	GA	30338	(678) 443-0644
MUNG, Francis Mang Thong	500 Ashwood Parkway	Dunwoody	GA	30338	(770) 522-5133
MUNG, Christopher	4274 Washington Rd	Evans	GA	30809	(706) 650-5040
THANG, Phun Hu	5119 Washington Road	Evans	GA	30809	(706) 650-1460
THANG, Pau Sian	5370 Campbellton Fairburns Road	Fairburn	GA	30213	(770) 774-3600
ADAM, AMIR	805 Glynn St. S Suite 117	Fayetteville	GA	30214	(770) 461-6880
SUI, Cing Lei	108 Pavilion Way	Fayetteville	GA	30214	(770) 460-4100
SHALOM, Pau Tuang	7380 Spout Springs Rd	Flowery Branch	GA	30542	(770) 965-5640
ENG, Sui	4025 Winder Hwy	Flowery Branch	GA	30542	(770) 539-5020
ENG, Sui	4025 Winder Hwy	Flowery Branch	GA	30542	(770) 539-5020
CING, Awi Nem	3446 Winder Hwy	Flowery Branch	GA	30542	(770) 538-4270
CING, Awi Nem	3446 Winder Hwy	Flowery Branch	GA	30542	(770) 538-4270
XIE, Jian Jun	5900 Spout Springs Rd	Flowery Branch	GA	30542	(770) 967-1303
PIANG, Kai Sawm	7334 Spout Springs Rd	Flowery Branch	GA	30542	(770) 967-1249
THU, Maung Myo Kyaw	3rd Ave By-Pass	Fort Gordon	GA	30905	(706) 791-3568
MUNG, Langh Khat	200 Vilseck Rd	Fort Stewart	GA	31314	(912) 767-9309
KAM, Pum Khan	3630 Thompson Bridge Rd.	Gainesville	GA	30506	(770) 532-1143
HMUNG, Bawiza	879 Dawsonville Highway	Gainesville	GA	30501	(770) 534-1350
NEM, Ctin Sian	2155 LIMESTONE RIDGE NE	GAINESVILLE	GA	30501	(678) 971-6207
PARK, Jong	1931 Jesse Jewell Pkwy	Gainesville	GA	30501	(470) 252-3182
PARK, Charles	1911 Grayson Hwy.	Grayson	GA	30017	(770) 237-2531
TANG, Chongqiu	1524 Highway 16 West	Griffin	GA	30223	(770) 229-7427
THAWNG, Kil Lin	435 Lewiston Road	Grovetown	GA	30813	(706) 619-3420
LIAN, Thang Deih	555 West Oglethorpe Highway	Hinesville	GA	31313	(912) 876-6010
LIAN, Thang Deih	555 West Oglethorpe Highway	Hinesville	GA	31313	(912) 876-6010
LIAN, Thang Deih	555 West Oglethorpe Highway	Hinesville	GA	31313	(912) 876-6010
AUNG, Thein	115 Bill Wigington Parkway	Jasper	GA	30143	(706) 692-1200
CHA, David H.	1685 Old Pendergrass Rd	Jefferson	GA	30549	(706) 387-7600
GAO, Hang	51 Old Farm Road	Jefferson	GA	30549	(706) 708-5216
TIAM, Bawi Peng Bual	11585 Jones Bridge Rd	Johns Creek	GA	30022	(770) 751-4580
TIAM, Bawi Peng Bual	11585 Jones Bridge Rd	Johns Creek	GA	30022	(770) 751-4580
TUN, Lin Eithet	1114 Highway 96	Kathleen	GA	31047	(478) 987-6707
TUN, Lin Eithet	1114 Highway 96	Kathleen	GA	31047	(478) 987-6707
TUN, Lin Eithet	1114 Highway 96	Kathleen	GA	31047	(478) 987-6707
HANG, Gin Khan	3895 Cherokee Street NW	Kennesaw	GA	30144	(770) 218-7030
BIK, Tha	4430 Wade Green Rd NW	Kennesaw	GA	30144	(770) 419-4030
YAO, Shengyun	2774 N. Cobb Parkway	Kennesaw	GA	30152	(770) 426-3240
YAO, Shengyun	2774 N. Cobb Parkway	Kennesaw	GA	30152	(770) 426-3240
MYINT, Zaw	1209 USS Daniel Boone Ave.	King's Bay	GA	31547	(912) 573-3310
MUAN, Thang Sian	1601 GA Highway 40 E	Kingsland	GA	31548	(912) 729-7878
MUAN, Thang Sian	1601 GA Highway 40 E	Kingsland	GA	31548	(912) 729-7878
Kham, Pau Sian	2200 VERNON STREET	LAGRANGE	GA	30240	(800) 242-1227
THAPA, Kumar	2100 Riverside Pkwy	Lawrenceville	GA	30043	(770) 962-0890
MENG, Qingbo	1475 Buford Drive	Lawrenceville	GA	30043	(770) 962-1317
THAPA, Kumar	2100 Riverside Pkwy	Lawrenceville	GA	30043	(770) 962-0890
THAPA, Kumar	2100 Riverside Pkwy	Lawrenceville	GA	30043	(770) 962-0890
LIAN, Tung Mun	1006 Martins Chapel Road	Lawrenceville	GA	30045	(800) 576-4377
THANG, Cin Sian	911 Duluth Highway	Lawrenceville	GA	30043	(770) 339-5600

Zenshi Food Service Counters

Franchise List

As of March 31, 2025

Franchisee Name	Address	City	State	Zip	Phone
FRAME, Dan	2380 Buford Dr. Ste 201	Lawrenceville	GA	30043-7638	(770) 338-4560
THANG, Eunice Tuanmawi	4850 Sugarloaf Pkwy	Lawrenceville	GA	30044	(770) 277-5240
THANG, Cin Sian	911 Duluth Highway	Lawrenceville	GA	30043	(770) 339-5600
THANG, Cin Sian	911 Duluth Highway	Lawrenceville	GA	30043	(770) 339-5600
TLAN, Henry	930 New Hope Rd.	Lawrenceville	GA	30045	(770) 682-2430
THANG, Cin Sian	911 Duluth Highway	Lawrenceville	GA	30043	(770) 339-5600
THANG, Cin Sian	911 Duluth Highway	Lawrenceville	GA	30043	(770) 339-5600
TLAN, Henry	930 New Hope Rd.	Lawrenceville	GA	30045	(770) 682-2430
TLAN, Henry	930 New Hope Rd.	Lawrenceville	GA	30045	(770) 682-2430
SANG, Mung Sian	1212 US 19	Leesburg	GA	31763	(229) 431-0294
FEI, Xueru	3050 Five Forks Triikum Road	Lilburn	GA	30047	(770) 978-9264
LIAN, John	4155 Lawrenceville Hwy NW	Lilburn	GA	30047	(770) 717-3044
KO, Chris L.	4045 Five Forks Trickum Rd	Lilburn	GA	30047	(770) 381-4170
TUANG, Kap Thawn	2675 Lee Rd	Lithia Springs	GA	30122	(770) 920-3471
TUANG, Kap Thawn	2675 Lee Rd	Lithia Springs	GA	30122	(770) 920-3471
KHUP, Nang Kim	3045 Panola Rd	Lithonia	GA	30038-2317	(770) 322-1890
CUNG, Run	2730 Highway 155 South	Locust Grove	GA	30248	(770) 288-4180
CUNG, Run	2730 Highway 155 South	Locust Grove	GA	30248	(770) 288-4180
MUNG, Khai Lian	910 Athens Highway	Loganville	GA	30052	(770) 554-1100
MUNG, Kam Khan	4753 Atlanta Highway	Loganville	GA	30052	(678) 639-4474
SULTAN ANSARY, Rokiah Binti	4875 FLOYD ROAD SW	Mableton	GA	30126	(770) 732-2850
SULTAN ANSARY, Rokiah Binti	4875 FLOYD ROAD SW	Mableton	GA	30126	(770) 732-2850
SULTAN ANSARY, Rokiah Binti	4875 FLOYD ROAD SW	Mableton	GA	30126	(770) 732-2850
LIAN, Kha Pau	1025 Veterans Memorial Hwy S.E	Mableton	GA	30126	(678) 398-3651
LIAN, Kha Pau	1025 Veterans Memorial Hwy S.E	Mableton	GA	30126	(678) 398-3651
TUANG, Mung Cin	4650 Forsythe Road	Macon	GA	31210	(478) 474-7410
TUANG, Mung Cin	4650 Forsythe Road	Macon	GA	31210	(478) 474-7410
TUANG, Mung Cin	4650 Forsythe Road	Macon	GA	31210	(478) 474-7410
PIANG, Khai Deih	5928 Zebulan Rd.	Macon	GA	31210	(478) 757-4150
PIANG, Khai Deih	5928 Zebulan Rd.	Macon	GA	31210	(478) 757-4150
LAN, Elizabeth Suihlawnthar	5581 Thomaston Rd	Macon	GA	31220	(478) 474-4918
YU, Eun Sook	4880 Lower Roswell Rd.	Marietta	GA	30068	(770) 971-8801
KHAM, Paul Go Suan	3600 Dallas Highway	Marietta	GA	30064	(770) 424-0040
Thang, Van Biak	2100 Rosewell Rd.	Marietta	GA	30062	(770) 321-1080
THANG, Khup Go	1000 Whitlock Avenue	Marietta	GA	30064	(770) 421-7676
SANG, Pum Cing	3162 Johnson Ferry Rd	Marietta	GA	30062	(770) 650-6673
WONG, Victor	2960 Shallowford Rd.	Marietta	GA	30066	(770) 977-7724
SANG, Mungkai	1310 Powers Ferry Rd. SE	Marietta	GA	30067	(404) 496-7850
CUNG, Joseph	3605 Sandy Plains Rd. Ste 200	Marietta	GA	30066	(770) 578-6000
KHUP, Zam Suan	1750 Powder Springs Rd SW	Marietta	GA	30064	(770) 423-4160
U HLA, Maung	1100 Johnson Ferry Rd	Marietta	GA	30068	(770) 509-2350
KHUAL, Mung Khan	1050 E. Piedmont Rd Ste P	Marietta	GA	30062	(770) 509-3980
UK, Siang Lian	50 Barrett Parkway	Marietta	GA	30066	(770) 419-4043
YU, An	2500 Dallas Hwy SW	Marietta	GA	30064	(770) 426-3250
BIK, Chung Lian	2900 Delk Rd.	Marietta	GA	30067	(770) 612-5150
UK, Siang Lian	50 Barrett Parkway	Marietta	GA	30066	(770) 419-4043
KHUP, Zam Suan	1750 Powder Springs Rd SW	Marietta	GA	30064	(770) 423-4160
KHUAL, Mung Khan	1050 E. Piedmont Rd Ste P	Marietta	GA	30062	(770) 509-3980
MUNG, Pau Lian	4115 columbia Road	Martinez	GA	30907	(706) 863-9635
MUNG, Pau Lian	4115 columbia Road	Martinez	GA	30907	(706) 863-9635
MANG, Thang	403 Furrys Ferry Rd	Martinez	GA	30907	(706) 650-3360
SUNG, Par Tin	301 Jonesboro Road	McDonough	GA	30253	(770) 954-4370
SUNG, Par Tin	301 Jonesboro Road	McDonough	GA	30253	(770) 954-4370
ZAM, Gin Khan	920 Highway 81 East	McDonough	GA	30252	(770) 898-1213
ZAM, Gin Khan	920 Highway 81 East	McDonough	GA	30252	(770) 898-1213
SEN, Khup	3479 Highway 81 East	McDonough	GA	30252	(770) 305-9357
MANG, Sua	Kelleytown Village 3500 Highway 155 North	McDonough	GA	30252	(770) 288-8588
ZI, Ngun Par	2809 North Columbia Street	Milledgeville	GA	31061	(478) 414-2140
BAWI, Nau Lian	2775 NORTH COLUMBIA ST	MILLEDGEVILLE	GA	31061	(478) 223-5016
KIM, Niang H.	900 Pavilion Parkway	Monroe	GA	30656	(678) 635-4316
KIM, Niang H.	900 Pavilion Parkway	Monroe	GA	30656	(678) 635-4316
MUNG, Sut Suan	4333 George St.	Moody AFB	GA	31699	(229) 257-3384
PAR, Thla lang	2035 Mt. Zion Rd.	Morrow	GA	30260	(770) 472-4000
KHUP, Mun	378 Veteran's Pkwy North	Moultrie	GA	31788	(229) 217-4812
CHUNG, Che Suen	3150 East Highway 34	Newnan	GA	30265	(770) 254-3030
LIN, Wengong	1751 Newnan Crossing Blvd. E.	Newnan	GA	30265	(678) 423-5841
ZAW, Naung Latt	370 Bullsboro Dr.	Newnan	GA	30263	(770) 502-0693
NYEIN CHAN, Nyi Nyi	100 Glenda Trace	Newnan	GA	30265	(770) 502-0686
ZAW, Naung Latt	370 Bullsboro Dr.	Newnan	GA	30263	(770) 502-0693
THANG, Hang Khan	4000 N Hwy 29	Newnan	GA	30265	(678) 633-6167
THANG, Pau	6050 Singleton Rd	Norcross	GA	30093	(770) 242-3344

Zenshi Food Service Counters

Franchise List

As of March 31, 2025

Franchisee Name	Address	City	State	Zip	Phone
THANG, Pau	6050 Singleton Rd	Norcross	GA	30093	(770) 242-3344
THANG, Pau	6050 Singleton Rd	Norcross	GA	30093	(770) 242-3344
CUNG, Naomi Cer	3200 Holcomb Bridge Rd.	Norcross	GA	30092	(770) 417-5100
CUNG, Naomi Cer	3200 Holcomb Bridge Rd.	Norcross	GA	30092	(770) 417-5100
CUNG, Naomi Cer	3200 Holcomb Bridge Rd.	Norcross	GA	30092	(770) 417-5100
MUNG, Lian Hau	564 Crosstown Drive	Peachtree City	GA	30269	(770) 487-3602
THEIN, Naw May	1101 N. Peachtree Pkwy.	Peachtree City	GA	30269	(770) 486-7200
NO, Moses Mung	130 Peachtree East Shopping Ctr.	Peachtree City	GA	30269	(770) 486-2020
KHAN, Ayub	1200 Highway 74 S ste 20	Peachtree City	GA	30269	(770) 486-0133
KHAN, Ayub	1200 Highway 74 S ste 20	Peachtree City	GA	30269	(770) 486-0133
NO, Moses Mung	130 Peachtree East Shopping Ctr.	Peachtree City	GA	30269	(770) 486-2020
KHAI, Neng Za	465 Pooler Parkway	Pooler	GA	31322	(912) 330-7313
MANG, Pau Sian	101 Blue Moon Crossing	Pooler	GA	31322	(912) 450-1070
KHAM, Do Suan	4150 Macland Rd	Powder Springs	GA	30127	(770) 222-5190
KHAI, KAM	5100 Dallas Highway	Powder Springs	GA	30127	(770) 419-6000
KHAI, KAM	5100 Dallas Highway	Powder Springs	GA	30127	(770) 419-6000
LAM, Mang	3721 New Macland Rd.	Powder Springs	GA	30127	(770) 222-2972
LAM, Mang	3721 New Macland Rd.	Powder Springs	GA	30127	(770) 222-2972
KIM, Suan Khan	12800 Hwy 144 East	Richmond Hill	GA	31324	(912) 459-1171
JAHAO, Len	461 S. Columbia Ave	Rincon	GA	31326	(912) 584-7130
MANG, Hau Sawm	3775 Battlefield Parkway	Ringgold	GA	30736	(706) 858-6568
MANG, Pum Go	7125 Highway 85	Riverdale	GA	30274	(770) 996-2508
MANG, Pum Go	7125 Highway 85	Riverdale	GA	30274	(770) 996-2508
TUANG, Cin Pian	923 Macon St-Bldg 923	Robins AFB	GA	31098	(478) 222-7618
TUANG, Cin Pian	923 Macon St-Bldg 923	Robins AFB	GA	31098	(478) 222-7618
TUANG, Cin Pian	923 Macon St-Bldg 923	Robins AFB	GA	31098	(478) 222-7618
BAO, Donglin	1476 Turner McCall Blvd	Rome	GA	30161	(706) 290-8039
TANEDO, Christian Louie Padilla	435 Turner McCall Blvd, NE	Rome	GA	30165	(706) 291-3380
LIU, Xiao Ye	570 E Crossville Rd	Roswell	GA	30075	(770) 640-2070
NUAN, Mang E	2300 Holcomb Bridge Rd	Roswell	GA	30076	(678) 352-7488
NWE, Yin Su	4401 Shallowford Rd.	Roswell	GA	30075	(770) 640-6200
CUAI, Thla	885 Woodstock Rd	Roswell	GA	30075	(770) 552-4580
CUAI, Thla	885 Woodstock Rd	Roswell	GA	30075	(770) 552-4580
CUAI, Thla	885 Woodstock Rd	Roswell	GA	30075	(770) 552-4580
ZI, Aung	1425 Market Blvd.	Roswell	GA	30076	(770) 640-6035
YANG, Xuhui	6615 Roswell Rd NE	Sandy Springs	GA	30328	(404) 843-4340
KHAI, Tual Lam	311 East Gwinnett St.	Savannah	GA	31401	(912) 231-2260
PAT, Hau	7 Diamond Causeway	Savannah	GA	31406	(912) 353-4345
NAING, Nay Oo	495 Johnny Mercer Blvd	Savannah	GA	31410	(912) 897-8898
MUNG, Kam Lam	5720 OGEECHEE RD.	Savannah	GA	31405	(912) 235-3420
MUNG, Kam Lam	5720 OGEECHEE RD.	Savannah	GA	31405	(912) 235-3420
PAU, Khup H.	318 Mall Blvd	Savannah	GA	31406	(912) 354-7133
KHAI, Tual Lam	311 East Gwinnett St.	Savannah	GA	31401	(912) 231-2260
ZAM THANG, Suan	89 Haley Street	Savannah	GA	31409	(912) 315-5219
LIA, Naw	155 Johnny Mercer Blvd	Savannah	GA	31410	(912) 897-8100
LIA, Naw	155 Johnny Mercer Blvd	Savannah	GA	31410	(912) 897-8100
THANG, Pau Ngaih	5500 Abercorn St.	Savannah	GA	31405	(912) 353-1260
ZAM THANG, Suan	89 Haley Street	Savannah	GA	31409	(912) 315-5219
THANG, Pau Ngaih	5500 Abercorn St.	Savannah	GA	31405	(912) 353-1260
HASHIM, Hanifa	4715 S Atlanta Rd SE	Smyrna	GA	30080	(404) 792-6990
HASHIM, Hanifa	4715 S Atlanta Rd SE	Smyrna	GA	30080	(404) 792-6990
VANG, Theresa Ni Par Zi	4480 S. Cobb Dr.	Smyrna	GA	30080	(770) 434-6225
VANG, Theresa Ni Par Zi	4480 S. Cobb Dr.	Smyrna	GA	30080	(770) 434-6225
MUAN, Mang Sian	2955 Atlanta Road SE	Smyrna	GA	30080	(770) 319-1123
THANG, Anthony Hang Tung	3550 Centerville Hwy	Snellville	GA	30039	(770) 736-7800
PAR, Ni Len	1670 Highway 124	Snellville	GA	30078	(770) 985-3790
MILLER, Saw	3035 Scenic Hwy S	Snellville	GA	30039	(770) 982-0655
SANG, Lang Le	1905 Scenic Highway	Snellville	GA	30078	(770) 978-5800
SANG, Lang Le	1905 Scenic Highway	Snellville	GA	30078	(770) 978-5800
THAWNG, Van Sui	101 TORMENTA WAY	STATESBORO	GA	30458-5697	(912) 243-6225
KIM, Thang Tuat	250 E. Atlanta Rd.	Stockbridge	GA	30281	(770) 389-4666
KIM, Thang Tuat	250 E. Atlanta Rd.	Stockbridge	GA	30281	(770) 389-4666
SHI, Guang Xi	1227 Rockbridge Rd	Stone Mountain	GA	30087	(770) 225-1877
CHU, Yueh Jiuon	380 N. Deshon Rd.	Stone Mountain	GA	30087	(770) 879-2700
CHU, Yueh Jiuon	380 N. Deshon Rd.	Stone Mountain	GA	30087	(770) 879-2700
CHU, Yueh Jiuon	380 N. Deshon Rd.	Stone Mountain	GA	30087	(770) 879-2700
NEM, Vang Huai	1232 S Hairston Rd	Stone Mountain	GA	30088	(404) 292-6009
NEM, Vang Huai	1232 S Hairston Rd	Stone Mountain	GA	30088	(404) 292-6009
MANG, Ni Luai	6001 Cumming HWY	Sugar Hill	GA	30518	(678) 546-2148
GUAN, Ling	400 Peachtree Industrial Blvd.	Suwanee	GA	30024	(770) 932-4377
KOU, leng	3651 Peachtree Parkway	Suwanee	GA	30024	(770) 418-2377

Zenshi Food Service Counters

Franchise List

As of March 31, 2025

Franchisee Name	Address	City	State	Zip	Phone
ZAM, Cin Khan	3245 Peachtree Parkway	Suwanee	GA	30024	(770) 886-5335
KIM, Gracy H	1000 Peachtree Industrial Blvd	Suwanee	GA	30024	(770) 932-4300
ZAM, Cin Khan	3245 Peachtree Parkway	Suwanee	GA	30024	(770) 886-5335
THANG, Thang Seng	620 North Virginia Ave.	Tifton	GA	31794	(229) 386-1166
NANG, KHAI MUN	3959 Lavista Rd	Tucker	GA	30084	(770) 939-6304
NANG, KHAI MUN	3959 Lavista Rd	Tucker	GA	30084	(770) 939-6304
TU, Hua Mei	4357 Lawrenceville Hwy	Tucker	GA	30084	(770) 934-1104
NANG, KHAI MUN	3959 Lavista Rd	Tucker	GA	30084	(770) 939-6304
TLING, Dawt Tin	4650 Hugh Howell Rd	Tucker	GA	30084	(770) 934-4799
THANG , Hlawn Ceu	1512 Highway 74 N	Tyrone	GA	30290	(770) 774-2780
CING, Julia	4550 Jonesboro Road	Union City	GA	30291-2080	(770) 969-0269
CING, Julia	4550 Jonesboro Road	Union City	GA	30291-2080	(770) 969-0269
SAN, David Kim	1741 Gornto Rd	Valdosta	GA	31601	(229) 242-2409
KHAI, Michael	3330 Inner Perimeter Rd.	Valdosta	GA	31602	(229) 671-9835
MUNG, Thang Gin	103 MIRROR LAKE CONNECTOR, STE 200	VILLA RICA	GA	30180	(404) 907-1711
NEU, Cing	3094 Watson Blvd.	Warner Robins	GA	31093	(478) 971-2320
LEE, Haydee Grimanesa	2061 Experiment Station Rd	Watkinsville	GA	30677	(706) 769-2080
LANGH, Thang Suan	1606 Memorial Dr.	Waycross	GA	31501	(912) 287-2270
TAWNG, Mung	401 Gainesville Hwy	Winder	GA	30680	(863) 688-1188
SHALOM NL LLC.	17 Monroe Highway	Winder	GA	30680	(770) 307-2900
JANGAM, Thang	12050 Highway 92 Suite 112	Woodstock	GA	30188	(770) 591-2890
THANG, Dal Lian	5339 Old Hwy 5.	Woodstock	GA	30188	(770) 924-2557
JANGAM, Thang	12050 Highway 92 Suite 112	Woodstock	GA	30188	(770) 591-2890
KHAI, Enn Sun	4403 Towne Lake Parkway	Woodstock	GA	30189	(770) 516-2040
KHAI, Enn Sun	4403 Towne Lake Parkway	Woodstock	GA	30189	(770) 516-2040
THAWNG, Biak Tha	12165 Highway 92	Woodstock	GA	30188	(770) 517-1600
KHAI, Enn Sun	4403 Towne Lake Parkway	Woodstock	GA	30189	(770) 516-2040
Kahng, Sung W	91-1119 Keaunui Drive	Ewa Beach	HI	96706	(808) 683-3200
KIM, Scott	91-1119 Keaunui Drive	Ewa Beach	HI	96706	(808) 683-3200
MARIP, La	20 Hickam CT.	Hickam AFB	HI	96853	(808) 449-1363
ZATHANG, Van Mawng	381 E Maka'ala Street	Hilo	HI	96720	(808) 920-8870
CHOI, Wonchul	1360 Pali Hwy	Honolulu	HI	96813	(808) 566-6811
LI, Ben	2855 East Manoa Rd	Honolulu	HI	96822	(808) 988-2058
SAKAI, Akira	848 Ala Liliiko St.	Honolulu	HI	96818	(808) 831-6100
SAKAI, Akira	848 Ala Liliiko St.	Honolulu	HI	96818	(808) 831-6100
HUANG, Julie	377 KEAHOLE ST.	HONOLULU	HI	96825	(808) 396-6337
SAKAI, Akira	848 Ala Liliiko St.	Honolulu	HI	96818	(808) 831-6100
SAKAI, Akira	848 Ala Liliiko St.	Honolulu	HI	96818	(808) 831-6100
SHIN, Injoo	888 Kapahulu Ave.	Honolulu	HI	96816	(808) 733-2600
LA, Ah	1234 S Beretania Street	Honolulu	HI	96814	(808) 535-1780
MARIP, Nu Khawn	Sushi Bar Pearl Harbor Commissary	JBPBH	HI	96860-6000	(808) 471-8402
SHAN, Batmend Choidorj	1090 Hookele St	Kahului	HI	96732	(808) 359-2970
THWE, Myo Lin	1060 Keolu Drive	Kailua	HI	96734	(808) 266-5200
AUNG, Zaw Min	75-971 Henry Street	Kailua-Kona	HI	96740	(808) 329-2207
ARPIA, Carol M.	46-065 Kamehameha Hwy	Kaneohe	HI	96744	(808) 233-5800
ARPIA, Carol M.	46-065 Kamehameha Hwy	Kaneohe	HI	96744	(808) 233-5800
ARPIA, Carol M.	46-065 Kamehameha Hwy	Kaneohe	HI	96744	(808) 233-5800
LEE, Stella Kyoung	Marine Corps Base	Kaneohe Marine Corps	HI	96863	(808) 257-1463
LWIN, Khin Maung	4 - 831 Kuhio Highway	Kapaa	HI	96746	(808) 822-2464
GUNHTANG, Hkunsoi	277 Piikea Ave	Kihei	HI	96753	(808) 891-9120
SHAN, Zaw	1221 Honoapilani Hwy	Lahaina	HI	96761	(808) 667-4392
DASHI, Nwawn Jaing	4454 Nuhou Street	Lihue	HI	96766	(808) 246-0290
MAI, Lawalt Zaw	698 Trimble Rd.	WAHIAWA	HI	96786	(808) 655-5066
MARAN, Isaac Deeawng	58 Maui Lani Parkway	Wailuku	HI	96793	(808) 243-3522
WIN, Kaung Zaw	7100 W state St.	Boise	ID	83714	(208) 342-2756
MUNG, Nang Sian	4700 North Eagle Rd.	Boise	ID	83713	(208) 939-5145
WIN, Kaung Zaw	7100 W state St.	Boise	ID	83714	(208) 342-2756
KYAW, Pyae Phyoo	1520 N. Cole Road	Boise	ID	83704	(208) 375-2542
BLUT, Nay	10751 W. Overland Rd.	Boise	ID	83709	(208) 373-5200
HKEAT, Eh Paw	3527 South Federal Way	Boise	ID	83705	(208) 424-7500
HTOO, Nay	5230 W. Franklin Rd.	Boise	ID	83705	(208) 429-6400
HEIN, Kyaw	1650 W State Street	Boise	ID	83702	(208) 342-5651
MUNG, Nang Sian	4700 North Eagle Rd.	Boise	ID	83713	(208) 939-5145
THANG, Law Kee	560 West Kathleen Ave	Coeur D Alene	ID	83815	(208) 665-4700
SWE, Sanda	220 W Ironwood Drive	Coeur d'Alene	ID	83814	(208) 664-9101
LIAN, Kham	640 Highway 16	Emmett	ID	83617	(208) 365-4420
WAH, Mike	5425 Chinden Boulevard	Garden City	ID	83714	(208) 323-7020
SUAN, Nang Cin	590 East 17th Street	Idaho Falls	ID	83404	(208) 523-0950
LIAN, Do Cin	1705 West Broadway St.	Idaho Falls	ID	83402	(208) 522-3392
SUAN, Nang Cin	590 East 17th Street	Idaho Falls	ID	83404	(208) 523-0950
KIM, Biak Than	1555 Northgate Mile	Idaho Falls	ID	83401	(208) 535-2520

Zenshi Food Service Counters

Franchise List

As of March 31, 2025

Franchisee Name	Address	City	State	Zip	Phone
AWNG, J Sut	1024 21ST ST	Lewiston	ID	83501	(208) 743-1561
SIAM, Zir	411 Deinhard Ln	McCall	ID	83638	(208) 634-8719
ZAW, Maung Than	1850 E. Fairview Ave.	Meridian	ID	83642	(208) 887-5240
BLU, Nay	1400 West Chinden Blvd	Meridian	ID	83646	(208) 893-6000
HANG, Nang Pum	1320 S. Blaine St	Moscow	ID	83843	(208) 883-0713
HLAING, Razar	615 Gunfighter Ave.	Mt. Home AFB	ID	83648	(208) 828-2163
NUENG, Htee	50 Second St. South	Nampa	ID	83651	(208) 465-2824
PI, Dhang	330 E. Benton St.	Pocatello	ID	83201	(208) 233-0455
MUNG, Khual Khan	800 Yellowstone Ave.	Pocatello	ID	83201-4461	(208) 239-4000
CI, Men	705 Blue Lakes Blvd.	Twin Falls	ID	83301	(208) 736-5348
THAWNG, Cung Bawi	103 S Randall Rd.	Algonquin	IL	60102	(847) 854-0242
THAWNG, Cung Bawi	103 S Randall Rd.	Algonquin	IL	60102	(847) 854-0242
THAWNG, Cung Bawi	103 S Randall Rd.	Algonquin	IL	60102	(847) 854-0242
THUE, Saw Poe	966 State Route 59	Antioch	IL	60002	(847) 395-7363
LWIN, Milton Thar Phyo	1860 S. Arlington Heights Rd.	Arlington Heights	IL	60005	(847) 593-1730
NGUYEN, Thuy Phuong	440 E Rand Rd.	Arlington Heights	IL	60004	(847) 255-8740
LWIN, Milton Thar Phyo	1860 S. Arlington Heights Rd.	Arlington Heights	IL	60005	(847) 593-1730
LIAN, Zaeng	1157 Eola Road	Aurora	IL	60502	(630) 851-4657
LIAN, Zaeng	1157 Eola Road	Aurora	IL	60502	(630) 851-4657
CUNG, Hre	150 Main St.	Barrington	IL	60010	(847) 381-4525
CUNG, Hre	150 Main St.	Barrington	IL	60010	(847) 381-4525
THANGTUNG, Samuel	1405 W Garfield	Bartonville	IL	61607	(309) 697-8811
PIANG, Thang Kim	119 Randall Rd.	Batavia	IL	60510	(630) 879-6622
HO, Joanna	1127 S York St.	Bensenville	IL	60106	(630) 238-0170
LEE, Mark	7111 W. Cermak Rd.	Berwyn	IL	60402	(708) 426-7150
WIN, Khin Thuzar	2203 East Oakland Avenue	Bloomington	IL	61701	(309) 663-4012
IANG, C C	1200 W Boughton Rd.	Bolingbrook	IL	60440	(630) 226-1892
LOTONG, Ro Liansang	271 South Bolingbrook Drive	Bolingbrook	IL	60440	(630) 914-5494
PYAY, Aung Tha	633 Armour Rd	Bourbonnais	IL	60914	(815) 935-1650
KHAI, Paoen	750 Army Trail Rd	Carol Stream	IL	60188	(630) 289-3700
KHAI, Paoen	750 Army Trail Rd	Carol Stream	IL	60188	(630) 289-3700
MANG, Chung Kho	696 Northwest Hwy	Cary	IL	60013	(847) 639-3599
MANG, Chung Kho	696 Northwest Hwy	Cary	IL	60013	(847) 639-3599
LIU, Shan Shan	109 Mattis Rd	Champaign	IL	61821	(217) 351-2600
LIU, Shan Shan	109 Mattis Rd	Champaign	IL	61821	(217) 351-2600
LIU, Shan Shan	109 Mattis Rd	Champaign	IL	61821	(217) 351-2600
KHAING, Aung	2206 Barnes Blvd	Cherry Valley	IL	61012	(815) 332-7267
KHAING, Aung	2206 Barnes Blvd	Cherry Valley	IL	61012	(815) 332-7267
KHAING, Aung	2206 Barnes Blvd	Cherry Valley	IL	61012	(815) 332-7267
KHAING, Aung	2206 Barnes Blvd	Cherry Valley	IL	61012	(815) 332-7267
SOE, Myo Min	1655 E. 95th Street	Chicago	IL	60617	(773) 731-9086
SOE, Myo Min	1655 E. 95th Street	Chicago	IL	60617	(773) 731-9086
QI, Oscar	2550 N. Clybourn Ave.	Chicago	IL	60614	(773) 348-6426
TUANG, Kim Khan	1341 N Paulina	Chicago	IL	60622	(773) 342-3410
SOE, Myo Min	1655 E. 95th Street	Chicago	IL	60617	(773) 731-9086
NWE, Zin Mar	6014 S Cottage Grove Ave.	Chicago	IL	60637	(773) 358-4278
CHEN, Huan Hua	6430 Irving Park Rd.	Chicago	IL	60634	(773) 725-8900
SUN THANG, Ram Tiam Hngak	102 W. Division Street	Chicago	IL	60610	(312) 397-1130
LEE, Sung-Kyung	4660 W. Irving Park	Chicago	IL	60641	(773) 202-0211
PAK, Du Yon	1224 South Wabash	Chicago	IL	60605	(312) 663-0580
MUNG, Langh Suan	2520 N Narragansett Ave	Chicago	IL	60639	(773) 637-1631
HO, Peter	550 N. State St.	Chicago	IL	60610	(312) 527-2162
MUANG, Zo Kim	5516 N Clark	Chicago	IL	60640	(773) 728-7730
LIAN, Uk Peng	2940 N. Ashland Ave.	Chicago	IL	60657	(773) 871-8242
TUANG, Ciau Lam	4042 W. Foster Ave	Chicago	IL	60630	(773) 583-8080
THANG, Haw Pum	5343 N Broadway	Chicago	IL	60640	(723) 784-1922
SUNG, Ca Hlei	4355 N Sheridan Road	Chicago	IL	60613	(773) 477-7151
BAWI, Ciang Ngaih	3570 N. Elston Ave.	Chicago	IL	60618	(773) 583-9150
TUANG, Vung Khen	3531 North Broadway	Chicago	IL	60657	(773) 871-1054
CHONG, Lhing Nei	3630 N Southport	Chicago	IL	60613	(773) 327-2330
SAI NAW KHAM, Jonathan	6107 SOUTH ARCHER AVENUE	CHICAGO	IL	60638	(773) 735-0043
WU, Yan Yao	1340 S Canal Street	Chicago	IL	60607	(312) 850-3915
CING, Niang Go	5233 North Lincoln Avenue	Chicago	IL	60625	(773) 943-6042
RAM SUSHI INCORPORATED	7342 West Foster Ave	Chicago	IL	60656	(773) 775-6866
LIAN, Francis T	5545 Brainard Ave	Countryside	IL	60525	(708) 352-0120
LIAN, Francis T	5545 Brainard Ave	Countryside	IL	60525	(708) 352-0120
LIAN, Francis T	5545 Brainard Ave	Countryside	IL	60525	(708) 352-0120
KARING, Bawn Htoi	7335 S Cass Ave	Darien	IL	60561	(630) 960-3177
KARING, Bawn Htoi	7335 S Cass Ave	Darien	IL	60561	(630) 960-3177
SANGA, Zo Nun	3070 N Water St	Decatur	IL	62526	(217) 875-1296
SANGA, Zo Nun	3070 N Water St	Decatur	IL	62526	(217) 875-1296

Zenshi Food Service Counters

Franchise List

As of March 31, 2025

Franchisee Name	Address	City	State	Zip	Phone
BIK, CUNG	819 Elmhurst Rd.	Des Plaines	IL	60016	(847) 956-1220
BIK, CUNG	819 Elmhurst Rd.	Des Plaines	IL	60016	(847) 956-1220
BIAK, Van	2707 E. Division St.	Diamond	IL	60416	(877) 723-3929
LING, Lian Khar	1148 Ogden Ave	Downers Grove	IL	60515	(630) 963-0645
KHENG, Duh	1660 Larkin Ave	Elgin	IL	60123	(847) 695-7573
KHENG, Duh	1660 Larkin Ave	Elgin	IL	60123	(847) 695-7573
YOON, James Sangchul	20 W Biesterfield	Elk Grove Village	IL	60007	(847) 593-1112
YOON, James Sangchul	20 W Biesterfield	Elk Grove Village	IL	60007	(847) 593-1112
LIAN, Van	944 York Rd.	Elmhurst	IL	60126	(630) 834-0006
LIAN, Van	944 York Rd.	Elmhurst	IL	60126	(630) 834-0006
LIAN, Van	944 York Rd.	Elmhurst	IL	60126	(630) 834-0006
LIAN, Van	944 York Rd.	Elmhurst	IL	60126	(630) 834-0006
THU, Brian	2485 Howard St.	Evanston	IL	60202	(847) 328-9791
AUNG, Min Soe	1350 US Route 12	Fox Lake	IL	60020	8479739075
WIN, Nay Tun	800 NW Hwy 14	Fox River Grove	IL	60021	(815) 382-0981
THANG, Ram Zung	2164 Bloomingdale	Glendale Hts.	IL	60139	(630) 893-2770
LATT, Maung M	1340 Patriot Blvd	Glenview	IL	60026	(847) 657-3124
DION, Ki	2775 Pfingsten Rd	Glenview	IL	60026	(847) 564-8550
DION, Ki	2775 Pfingsten Rd	Glenview	IL	60026	(847) 564-8550
LIAN, Kumar C	885 E. Belvidere Rd.	Grayslake	IL	60030	(847) 543-8976
DAL , Man Khan	2630 Greenbay Rd.	Great Lakes	IL	60088	(847) 688-2644
OO, Tun Tun	9528 S Roberts Rd.	Hickory Hills	IL	60457	(708) 599-5514
THANG, Lian Min	1600 Deerfield Rd.	Highland Park	IL	60035	(847) 579-0872
THANG, Lian Min	1600 Deerfield Rd.	Highland Park	IL	60035	(847) 579-0872
THANG, Lian Min	1600 Deerfield Rd.	Highland Park	IL	60035	(847) 579-0872
MAUNG, Aung Myo	14200 S. Bell Rd.	Homer Glen	IL	60491	(708) 301-0984
THWE, Su Myat	17705 South Halsted St.	Homewood	IL	60430	(708) 957-1810
MAUNG, Zaw Theh	10090 HWY 47	Huntley	IL	60142	(847) 802-3357
MAUNG, Zaw Theh	10090 HWY 47	Huntley	IL	60142	(847) 802-3357
MAUNG, Zaw Theh	10090 HWY 47	Huntley	IL	60142	(847) 802-3357
WIN, Thi Thi	13200 Village Green Dr..	Huntley	IL	60142	(847) 961-5597
ZI, Ngun	485 Ela Rd.	Lake Zurich	IL	60047	(847) 438-7300
ZI, Ngun	485 Ela Rd.	Lake Zurich	IL	60047	(847) 438-7300
CHIN, Sui Tha	345 S Rand Rd	Lake Zurich	IL	60047	(847) 989-2962
OO, Aung Aung	1202 STATE STREET	Lemont	IL	60439	(630) 243-1925
THANG, Pau Sian S	1300 South Milwaukee	Libertyville	IL	60048	(847) 816-8200
THANG, Pau Sian S	1300 South Milwaukee	Libertyville	IL	60048	(847) 816-8200
SUI, Lily	1156 Maple Ave	Lisle	IL	60532	(630) 964-5166
SUI, Lily	1156 Maple Ave	Lisle	IL	60532	(630) 964-5166
SUI, Lily	1156 Maple Ave	Lisle	IL	60532	(630) 964-5166
NUN, Nang Lian	16625 W. 159th St.	Lockport	IL	60441	(815) 834-9516
NU, Sian	1177 S Main Street	Lombard	IL	60148	(630) 953-1390
KYI, Khin Maung	1704 Deyoung St.	Marion	IL	62959	(618) 993-6330
KYI, Khin Maung	1704 Deyoung St.	Marion	IL	62959	(618) 993-6330
KYI, Khin Maung	1704 Deyoung St.	Marion	IL	62959	(618) 993-6330
KYI, Khin Maung	1704 Deyoung St.	Marion	IL	62959	(618) 993-6330
LIAN , Van Bawi	4222 Elm Street	McHenry	IL	60050	(815) 385-7030
LIAN , Van Bawi	4222 Elm Street	McHenry	IL	60050	(815) 385-7030
TUN, Mehm Nyan	2051 Ridge Road	Minooka	IL	60447	(815) 467-0924
CEU, Phun	2010 1st Street A	Moline	IL	61265	(309) 797-0558
CEU, Phun	2010 1st Street A	Moline	IL	61265	(309) 797-0558
CEU, Phun	2010 1st Street A	Moline	IL	61265	(309) 797-0558
MARIP, Ah Lawt	1414 North Division	Morris	IL	60450	(815) 942-2374
LIAN, Henry V	1001 West Jackson	Morton	IL	61550	(309) 266-5366
LIAN, Henry V	1001 West Jackson	Morton	IL	61550	(309) 266-5366
HLUN, Tial	415 South 42nd Street	Mt. Vernon	IL	62864	(618) 244-6210
THANG, Zung Tin	1150 West Maple Ave.	Mundelein	IL	60060	(847) 970-9250
Kee, Nant S.	1501 S Lake St.	Mundelein	IL	60060	(847) 566-6161
AUNGNANG, Naikyal	2855 W 95th Street	Naperville	IL	60564	(630) 904-5119
ZAATHANG, Ngun Thamawi	1759 W Ogden Ave.	Naperville	IL	60540	(630) 355-2172
KYANT, Sai Long	127 E. Ogden	Naperville	IL	60563	(630) 357-1040
KYANT, Sai Long	127 E. Ogden	Naperville	IL	60563	(630) 357-1040
WAI, Myo Tun	475 N Nelson Rd	New Lenox	IL	60451	(815) 462-0018
CHONG, Moses	7900 N. Milwaukee Ave	Niles	IL	60714	(847) 965-3925
CHONG, Moses	7900 N. Milwaukee Ave	Niles	IL	60714	(847) 965-3925
MUNG, Lian Kap	8730 W Dempster St	Niles,	IL	60714	(847) 298-6352
MUNG, Lian Kap	8730 W Dempster St	Niles,	IL	60714	(847) 298-6352
HTAIKE, Nai Than	1550 E College Ave	Normal	IL	61761	(309) 452-7476
KHAM, Vung Zuan	5616 W 159th Street	Oak Forest	IL	60452	(708) 614-6700
RUAN, Yun F.	9424 S Pulaski	Oak Lawn	IL	60453	(708) 857-8274
RUAN, Yun F.	9424 S Pulaski	Oak Lawn	IL	60453	(708) 857-8274

Zenshi Food Service Counters

Franchise List

As of March 31, 2025

Franchisee Name	Address	City	State	Zip	Phone
THANG, Langh Tuan	3795 Orchard Road	Oswego	IL	60543	(630) 551-1347
THANG, Langh Tuan	3795 Orchard Road	Oswego	IL	60543	(630) 551-1347
THANG, Langh Tuan	3795 Orchard Road	Oswego	IL	60543	(630) 551-1347
JEONG, Hyojung Cho	45 South Plum Grove Road	Palatine	IL	60067	(847) 991-1888
SANG, Suan Thawn	423 E. Dundee Rd	Palatine	IL	60074	(847) 991-4545
JEONG, Hyojung Cho	45 South Plum Grove Road	Palatine	IL	60067	(847) 991-1888
GO CIN KHUAL, Gabriel	1607 Broadway Street	Pekin	IL	61554	(309) 353-5300
SING, Mang Za	9219 N Lindbergh Dr,	Peoria	IL	61615	(309) 691-8701
TLUANG DO, Biak Hmun Sang	2480 S. Route 59	Plainfield	IL	60586	(815) 254-3391
MEI, Jingjian	13460 S. Route. 59	Plainfield	IL	60585	(815) 577-2605
CI, Hniang	1241 N. Rand Road	Prospect Heights	IL	60004	(847) 394-1000
CANGMAH, Ring Thang	20 South Weber Rd.	Romeoville	IL	60446	(815) 293-0665
LYNN, Victoria	3220 Chicago Rd.	S. Chicago Heights	IL	60411	(708) 755-7372
TUANG, Pum Siam	2501 W. Schaumburg Rd.	Schaumburg	IL	60194	(847) 524-8960
TUANG, Pum Siam	2501 W. Schaumburg Rd.	Schaumburg	IL	60194	(847) 524-8960
SWE, Thet Min	1151 S Roselle Rd.	Schaumburg	IL	60193	(847) 891-8388
PATRATA, Marissa Aluran	203 West Winters St.	Scott AFB	IL	62225	(618) 212-3898
NAING, Soe	199 Brookforest Ave	Shorewood	IL	60404	(815) 730-3944
NAING, Soe	199 Brookforest Ave	Shorewood	IL	60404	(815) 730-3944
NAING, Soe	199 Brookforest Ave	Shorewood	IL	60404	(815) 730-3944
SHUI, Lee	9449 Skokie Blvd	Skokie	IL	60077	(847) 677-3331
MUNG, Thang Do	375 Randall Rd.	South Elgin	IL	60177	(847) 608-1460
KOP, Paa Sian	2801 Chatham Rd.	Springfield	IL	62704	(217) 698-2980
KOP, Paa Sian	2801 Chatham Rd.	Springfield	IL	62704	(217) 698-2980
NON, Chan Na	652 Kirk Rd.	St. Charles	IL	60174	(630) 587-0847
NON, Chan Na	652 Kirk Rd.	St. Charles	IL	60174	(630) 587-0847
HNINN, Nwe Nwe	7122 W. 40TH ST	Stickney	IL	60402	(708) 484-8421
AYE, Mah	33 St. Charles Rd	Villa Park	IL	60181	(630) 279-8900
AYE, Mah	33 St. Charles Rd	Villa Park	IL	60181	(630) 279-8900
CHERPUT, Cdin Thanga	3124 N Lewis Ave	Waukegan	IL	60087	(847) 249-1130
CHERPUT, Cdin Thanga	3124 N Lewis Ave	Waukegan	IL	60087	(847) 249-1130
CHERPUT, Cdin Thanga	3124 N Lewis Ave	Waukegan	IL	60087	(847) 249-1130
NAWL, UK	2031 N Main Street	Wheaton	IL	60187	(630) 682-0220
NAWL, UK	2031 N Main Street	Wheaton	IL	60187	(630) 682-0220
AUNG, Myint	411 North Green Bay Rd.	Wilmette	IL	60091	(847) 256-7420
AUNG, Myint	411 North Green Bay Rd.	Wilmette	IL	60091	(847) 256-7420
NAW, Ja	343 W Irving Park Rd	Wood Dale	IL	60191	(630) 773-4326
BAWKKHENG, Bual Tial	2317 W 75th Street	Woodridge	IL	60517	(630) 985-9380
THU, Maw	4025 S Old State Road 37	Bloomington	IN	47401	(812) 824-5200
VUNG, Zo Ngur	5810 E 71St St	Indianapolis	IN	46220	(317) 845-9653
THANG, Ci Lian	2864 Charlestown Rd.	Albany	IN	47150	(812) 944-7016
THANG, Ci Lian	2864 Charlestown Rd.	Albany	IN	47150	(812) 944-7016
BIK, Cung Lian	1845 North Scatterfield Rd	Anderson	IN	46012	(765) 649-2276
LIAN, Van Cung	108 N Avon Ave	Avon	IN	46123	(317) 272-4130
MAUNG, Tial	528 S College Ave	Bloomington	IN	47403	(812) 339-3351
LIAN, Van Thawng	1825 Kinsler Pike	Bloomington	IN	47404	(812) 335-6760
HMUNG, Sui Hre	1175 S College Mall Rd	Bloomington	IN	47401	(812) 333-5766
HMUNG, Van Lian	500 S. Liberty Drive	Bloomington	IN	47403	(812) 349-1385
MANG, Ceu Chin	975 N. Green St.	Brownsburg	IN	46112	(317) 852-6076
MANGHLEI, Niuk	1217 S. Rangeline Rd.	Carmel	IN	46032	(317) 843-4431
THA, Aya Ni	9605 Lincoln Plaza	Cedar Lake	IN	46303	(219) 374-6300
DIN, Ma	747 Indian Boundary Rd	Chesterton	IN	46304	(219) 926-7172
LIAN KHAM, Khin Maung	1600 Pioneer TRL	Chesterton	IN	46304-9382	(219) 929-1717
NAI, Nai Banyan	621 Countryside Drive	Columbia City	IN	46725	(260) 244-3290
ZAATHANG, Chansawlin	3060 National Road	Columbus	IN	47201	(812) 376-9451
HNIANG, Amy Sui	389 Old Capital Plaza NW	Corydon	IN	47112	(812) 738-3225
HNIANG, Amy Sui	389 Old Capital Plaza NW	Corydon	IN	47112	(812) 738-3225
HNIANG, Amy Sui	389 Old Capital Plaza NW	Corydon	IN	47112	(812) 738-3225
BRANG, Ah	10839 Randolph Street	Crown Point	IN	46307	(219) 661-1400
BIK, Benjamin Tha Hlei	10851 Broadway	Crown Point	IN	46307	(219) 661-4144
LIAN, Thang Ci	785 East Main Street	Danville	IN	46122	(317) 745-8020
LANGLE, Win Maung	805 Joliet Street	Dyer	IN	46311	(219) 864-0078
LANGLE, Win Maung	805 Joliet Street	Dyer	IN	46311	(219) 864-0078
HLAWNCEU, Tin Mang	3800 East Mishawaka Rd.	Elkhart	IN	46517	(574) 875-6211
LIAN, Cung Nawl	575 E Jackson Blvd.	Elkhart	IN	46516	(574) 293-6659
HLAWNCEU, Tin Mang	3800 East Mishawaka Rd.	Elkhart	IN	46517	(574) 875-6211
PI, Tuang	3700 First Ave	Evansville	IN	47710	(812) 464-3920
PI, Tuang	3700 First Ave	Evansville	IN	47710	(812) 464-3920
PI, Tuang	3700 First Ave	Evansville	IN	47710	(812) 464-3920
ZATHANG, Tha	3501 N. Green River Rd.	Evansville	IN	47715	(812) 473-4510
ZATHANG, Tha	3501 N. Green River Rd.	Evansville	IN	47715	(812) 473-4510

Zenshi Food Service Counters

Franchise List

As of March 31, 2025

Franchisee Name	Address	City	State	Zip	Phone
PI, Tuang	3700 First Ave	Evansville	IN	47710	(812) 464-3920
MANG TEI, Amos	7450 Fishers Station Drive	Fishers	IN	46038-2323	(317) 579-0201
HNIN, Sultin Cer	11700 Olio Road	Fishers	IN	46037	(317) 598-8400
ZATHANG, Carson Lenza	9799 E. 116th Street	Fishers	IN	46037	(317) 913-5500
SORN, Jaw	4120 N Clinton Road	Fort Wayne	IN	46805	(260) 484-7021
KHAM, Gregory Thang Suan	1125 W State Blvd	Fort Wayne	IN	46808	(260) 426-3453
KHAM, Gregory Thang Suan	1125 W State Blvd	Fort Wayne	IN	46808	(260) 426-3453
CLASS, Nai	6310 E. State Blvd	Fort Wayne	IN	46815	(260) 749-5102
CLASS, Nai	6310 E. State Blvd	Fort Wayne	IN	46815	(260) 749-5102
KHAM, Gregory Thang Suan	1125 W State Blvd	Fort Wayne	IN	46808	(260) 426-3453
DAL, Kham Khen	601 East DuPont Road	Fort Wayne	IN	46825	(260) 637-4504
MAI, Christina Doi	6002 St. Jose Center Road	Fort Wayne	IN	46835	(260) 485-9611
HTAY, Maung	5725 Coventry Lane	Fort Wayne	IN	46804	(260) 432-2305
THLUAI, Ngun Tin	970 North Morton Street	Franklin	IN	46131	(317) 736-6004
SAW, Min Min	209 Chicago Ave	Goshen	IN	46526	(574) 533-9949
SAW, Min Min	209 Chicago Ave	Goshen	IN	46526	(574) 533-9949
CEU, Nei	1527 Bashore Rd.	Goshen	IN	46528	(574) 537-0719
BIK, Lawn	7355 Heritage Square Dr.	Granger	IN	46530	(574) 807-8220
CHERPUT, Vanlal Muana	821 Indianapolis Road	Greencastle	IN	46135	(765) 653-8032
KI, Dawt	1571 North State Street	Greenfield	IN	46140	(317) 462-3451
THANG, Maung Lian	5961 N STATE ROAD 135	Greenwood	IN	46143	(317) 530-3086
LING, Ceu	2200 Independence Dr.	Greenwood	IN	46143	(317) 883-4140
THAWNG, Cung	3100 Meridian Park Drive	Greenwood	IN	46142	(317) 887-5745
THAWNG, Cung	3100 Meridian Park Drive	Greenwood	IN	46142	(317) 887-5745
HMUNG, Ngun	9632 Cline Ave	Highland	IN	46322	(219) 924-6932
MOO, Saw Kyaw	7760 E RIDGE RD	Hobart	IN	46324	(219) 962-1115
THANG, Sairas	2629 East 65th Street	Indianapolis	IN	46220	(317) 255-1498
KHUMA, Ri	7101 E. 10th Street	Indianapolis	IN	46219	(317) 352-1721
LUAI, Ngun Li	680 Twin Aire Dr.	Indianapolis	IN	46203	(317) 264-1762
NUN, Joel Bawi	227 W. Michigan Street	Indianapolis	IN	46204	(317) 262-5215
Van, Chris Thawngci	5718 Crawfordsville Road	Indianapolis	IN	46224	(317) 240-5000
KHUMA, Ri	7101 E. 10th Street	Indianapolis	IN	46219	(317) 352-1721
MON HONG ZAR, Aie Weng	11101 Pendleton Pike	Indianapolis	IN	46236	(317) 823-3240
HU, Lian Z.	8745 S Emerson Ave	Indianapolis	IN	46237	(317) 884-3320
HLEN, Mang	2550 Lake Circle Lane	Indianapolis	IN	46268	(317) 879-2460
CUNG, James Vanbiak	4202 S. East Street	Indianapolis	IN	46227	(317) 721-4245
KHUMA, Ri	7101 E. 10th Street	Indianapolis	IN	46219	(317) 352-1721
HLEN, Mang	2550 Lake Circle Lane	Indianapolis	IN	46268	(317) 879-2460
MON HONG ZAR, Aie Weng	11101 Pendleton Pike	Indianapolis	IN	46236	(317) 823-3240
AWM, Lal Rin	8130 E. Southport Road	Indianapolis	IN	46259	(317) 245-4453
CING, Cing	5911 South Madison Avenue	Indianapolis	IN	46227	(317) 783-4947
SIN, Grace Hniarcer	1330 West Southport Road	Indianapolis	IN	46217	(317) 884-4245
LUAI, Ngun Li	680 Twin Aire Dr.	Indianapolis	IN	46203	(317) 264-1762
FACHAI, Nawbi	1365 E.86th Street	Indianapolis	IN	46240	(317) 217-1190
SADAI, EI	310 W North St	Kendallville	IN	46755	(260) 347-9155
THANG, Van	2821 S Washington St	Kokomo	IN	46902	(765) 453-7556
THANG, Van	2821 S Washington St	Kokomo	IN	46902	(765) 453-7556
MANG, Steven H.	2513 Maple Point Dr.	Lafayette	IN	47905	(765) 447-7533
RAMMAHTAW, Ong Sike	2420 N. Lebanon Street	Lebanon	IN	46052	(765) 482-7274
HTOI, Alexander Zaw	2080 E. Commercial Ave.	Lowell	IN	46356	(219) 696-6633
LEN, Za Nei Par	1600 S. Ohio	Martinsville	IN	46151	(765) 342-7151
SAM RA, Zau Hkun	6001 Broadway Ave.	Merrillville	IN	46410	(219) 980-1468
TIN, Joseph Cungzauk	306 N. Bittersweet	Mishawaka	IN	46544	(574) 259-2405
TIN, Joseph Cungzauk	306 N. Bittersweet	Mishawaka	IN	46544	(574) 259-2405
RAMARN, Nai	1500 W. McGalliard	Muncie	IN	47304	(765) 751-1500
KIM, Van Nuam	715 S. Tillotson Ave.	Muncie	IN	47304	(765) 213-1200
SUE, Charity Phaw Thein	12 Ridge Road	Munster	IN	46321	(219) 836-8414
HMUNG, Duh That	242 North Oakland Ave	Nappanee	IN	46550	(574) 773-3013
HMUNG, Duh That	242 North Oakland Ave	Nappanee	IN	46550	(574) 773-3013
THANG, Lian Khawcin	172 W. Logan Street	Noblesville	IN	46060	(317) 776-3344
KHAI, Go Khan	14800 Hazel Dell Crossing	Noblesville	IN	46062	(317) 844-1004
NAWLTHANG, Ngun Hleital	1930 E Main St	Plainfield	IN	46168	(317) 839-7961
KHUM, Za Lian	865 E Jefferson Street	Plymouth	IN	46563	(269) 936-4081
KZ THANDAR LLC.	6046 Central Ave.	Portage	IN	46368	(219) 762-9518
MUANG, Thang Sian	3701 National Road E	Richmond	IN	47374	(765) 935-1244
LAI, Tei Thau	1515 Us Highway 41	Schererville	IN	46375	(219) 865-8990
RUAT, Lal Rem	7605 High Way 311	Sellersburg	IN	47172	(812) 246-4730
RUAT, Lal Rem	7605 High Way 311	Sellersburg	IN	47172	(812) 246-4730
THANG, Uk Tha	1601 E Michigan Rd	Shelbyville	IN	46176	(317) 421-3250
THANG, Uk Tha	1601 E Michigan Rd	Shelbyville	IN	46176	(317) 421-3250
YEENA, Daryusi	525 S. Mayflower Road	South Bend	IN	46619	(574) 288-4854

Zenshi Food Service Counters

Franchise List

As of March 31, 2025

Franchisee Name	Address	City	State	Zip	Phone
YEENA, Daryusi	525 S. Mayflower Road	South Bend	IN	46619	(574) 288-4854
LIAN, Ngun Hmung	9825 Wicker Ave	St. John	IN	46373	(219) 365-7717
MANG, Tial Cung	2140 Fort Harrison Rd	Terre Haute	IN	47804	(812) 466-6861
MANG, Tial Cung	2140 Fort Harrison Rd	Terre Haute	IN	47804	(812) 466-6861
MANG, Tial Cung	2140 Fort Harrison Rd	Terre Haute	IN	47804	(812) 466-6861
MYI SHI, Mung San	2168 W Highway 30	Valparaiso	IN	46385	(219) 462-5147
BERLYTHA, Peter K	2800 N. Calumet Ave	Valparaiso	IN	46383	(219) 464-3571
THANG, David Van Ro	2211 E Center Street	Warsaw	IN	46580	(574) 267-8848
TUANG, Kam Sian	1150 Husky Trail	Warsaw	IN	46582	(574) 371-9000
TUANG, Kam Sian	1150 Husky Trail	Warsaw	IN	46582	(574) 371-9000
ZAA THANG, Biak Hlei	1032 Sagamore Pkwy W	West Lafayette	IN	47906	(765) 464-1456
CEM, Cung Dawt	150 W. 161 Street	Westfield	IN	46074	(317) 867-6314
CIN, Hrang Kap	17447 Carey Road	Westfield	IN	46074	(317) 867-1002
DIM, Tial	10679 N. Michigan Road	Zionsville	IN	46077	(317) 733-2560
PENG, Hram	5 Boone Village	Zionsville	IN	46077	(317) 873-2366
ROT, Nai Mangay	225 E. Cloud	Andover	KS	67002	(316) 733-3720
ROT, Nai Mangay	225 E. Cloud	Andover	KS	67002	(316) 733-3720
CHAN, Aye	1624 N. Rock Road	Derby	KS	67037	(316) 554-2129
BOUTHAVONG, Tasha Soukphaphone	1700 N. 14th Street	Dodge City	KS	67801	(620) 225-6130
KHAI, Nang Suan	700 N Main St.	El Dorado	KS	67042	(316) 321-0332
LET, Suang Khua	310 Kansas Ave	Fort Leavenworth	KS	66027	(913) 684-4903
MAUNG, Than Tin	2310 Trooper Dr. Bldg #231	Fort Riley	KS	66442	(785) 239-0521
PAW, Moe Eh	1305 East Kansas	Garden City	KS	67846	(620) 275-4274
PAW, Moe Eh	1305 East Kansas	Garden City	KS	67846	(620) 275-4274
TE, Kim	531 West 27Th Street	Hays	KS	67601	(785) 628-1016
TE, Kim	531 West 27Th Street	Hays	KS	67601	(785) 628-1016
NAUNG, Htoo Myat	206 W 5Th Ave	Hutchinson	KS	67501	(620) 663-4464
NAUNG, Htoo Myat	206 W 5Th Ave	Hutchinson	KS	67501	(620) 663-4464
LE, Hmung	4701 West 6th	Lawrence	KS	66049	(785) 838-0100
KHAM, Kham	3000 W. 6th St.	Lawrence	KS	66049	(785) 843-0652
TLING, Law	1015 W. 23rd St.	Lawrence	KS	66046	(785) 841-3366
SUI, Mah	1740 Massachusetts St.	Lawrence	KS	66044	(785) 842-2434
THIAM, Lydia Van Nei	720 Eisenhower Road	Leavenworth	KS	66048	(913) 250-3500
TUANG, Dal Khan	130 Sarber Lane	Manhattan	KS	66502	(785) 776-9285
TUANG, Dal Khan	130 Sarber Lane	Manhattan	KS	66502	(785) 776-9285
LASHAM, Tu Lum	1101 Westloop Place	Manhattan	KS	66502	(785) 539-7631
LIAN, Khai Sawm	1410 S Kansas	Newston	KS	67114	(316) 284-3720
LIAN, Khai Sawm	1410 S Kansas	Newston	KS	67114	(316) 284-3720
LAZUM, Seng Naw	2350 Planet Ave	Salina	KS	67401	(785) 823-9403
LAZUM, Seng Naw	2350 Planet Ave	Salina	KS	67401	(785) 823-9403
IANG, Sui Fom Chen	6829 SW 29th St.	Topeka	KS	66614	(785) 228-4200
BILL, Anthony	800 NW 25th Street	Topeka	KS	66618	(785) 357-2660
YOUNGPOEIH, Boeithang Batu	2010 SE 29th Street	Topeka	KS	66605	(785) 267-1797
IANG, Sui Fom Chen	6829 SW 29th St.	Topeka	KS	66614	(785) 228-4200
LIAN, ZA HEI	4015 S.W. 10th Street	Topeka	KS	66604	(785) 228-8700
NAW, THIDAR WIN	9450 East Harry	Wichita	KS	67207	(316) 651-2720
CIN, Van Cer	8828 W 13th Street N	Wichita	KS	67212	(316) 722-5690
KHIN, Thanda	7707 E. Central	Wichita	KS	67206	(316) 651-2700
OO, Lay Naing	10222 W 21st	Wichita	KS	67205	(316) 729-1530
SANAY, Linnai	3707 North Woodlawn	Wichita	KS	67220	(316) 691-9130
CIN, Van Cer	8828 W 13th Street N	Wichita	KS	67212	(316) 722-5690
MYINT, Naing Naing	2244 North Rock Rd. Ct.	Wichita	KS	67226	(316) 685-5844
SOE, Thike	10515 W Central	Wichita	KS	67212	(316) 729-0050
CIN, Van Cer	8828 W 13th Street N	Wichita	KS	67212	(316) 722-5690
SOE, Thike	10515 W Central	Wichita	KS	67212	(316) 729-0050
NAW, THIDAR WIN	9450 East Harry	Wichita	KS	67207	(316) 651-2720
SOE, Thike	10515 W Central	Wichita	KS	67212	(316) 729-0050
HOO, Saw Shadey	53327 Derby Court Building	Wichita	KS	67221	(316) 759-5621
KHUN, Mark	4747 South Broadway	Wichita	KS	67216	(316) 529-9030
KYI, Khando	711 Martin Luther King Jr.	Ashland	KY	41101	(606) 325-8231
KYI, Khando	711 Martin Luther King Jr.	Ashland	KY	41101	(606) 325-8231
LIAN, Ezra Ngun Thawm	102 West John Rowan Blvd	Bardstown	KY	40004	(502) 348-2864
MUNG, Zam	711 Campbell Lane	Bowling Green	KY	42104	(270) 783-0701
WEI, Wei	350 US 31W BYP.	Bowling Green	KY	42101	(270) 796-5987
WEI, Wei	350 US 31W BYP.	Bowling Green	KY	42101	(270) 796-5987
THAR, David Lal Nun	568 River Ridge Plaza	Brandenburg	KY	40108	(270) 422-5464
LIAN, Tun Tuang	2835 S. Highway 393	Buckner	KY	40031	(800) 576-4377
CHIN, Rebecca	111 Towne Drive	Elizabethtown	KY	42701	(270) 737-1707
OO, Sandar	3040 Dolphin Drive	Elizabethtown	KY	42701	(270) 765-5229
HNIANG, Rang K	2606 Indiana Ave	Fort Campbell	KY	42223	(270) 640-4008
LIAN, Ceu Cung	1309 US HIGHWAY 127 S	Frankfort	KY	40601	(502) 875-0124

Zenshi Food Service Counters

Franchise List

As of March 31, 2025

Franchisee Name	Address	City	State	Zip	Phone
OO, Than Myo	302 Brighton Park Blvd	Frankfort	KY	40601	(502) 695-4860
MYINT, Sar Sar	106 Marketplace Circle	Georgetown	KY	40324	(502) 868-5068
KO KO, Maung Win Htet	844 S College St	Harrodsburg	KY	40330	(859) 734-0081
KO KO, Maung Win Htet	844 S College St	Harrodsburg	KY	40330	(859) 734-0081
CHAN, Rebecca	4110 Tates Creek Centre Drive	Lexington	KY	40517	(859) 273-1100
SOE, Maung Maung	150 W Lowry Lane	Lexington	KY	40503	(859) 278-6228
MO, Sai	1650 BRYAN STATION ROAD	LEXINGTON	KY	40505	(859) 293-5969
SUAN, Pau Za	1808 Alexandria Drive	Lexington	KY	40504	(859) 276-3556
CUNG, Van La	3650 Boston Road	Lexington	KY	40514	(859) 223-8088
TUN, Oo Kyaw	3101 Richmond Road	Lexington	KY	40509	(859) 266-9205
MO, Sai	1650 BRYAN STATION ROAD	LEXINGTON	KY	40505	(859) 293-5969
CUNG, Van La	3650 Boston Road	Lexington	KY	40514	(859) 223-8088
LWIN, Win Aung	1060 CHINOE ROAD	Lexington	KY	40502	(859) 335-4706
TLUANGA, Jonathan Lahnun	3175 Beaumont Center Circle	Lexington	KY	40513	(859) 219-1091
KO, Win Min	1600 LEESTOWN RD, Suite 150	Lexington	KY	40511	(859) 259-0933
ZAN, Myat Myat	704 Euclid Ave	Lexington	KY	40502	(859) 269-6804
SOE, Maung Maung	150 W Lowry Lane	Lexington	KY	40503	(859) 278-6228
MIN, Paing Soe	1952 Stockton Way	Lexington	KY	40511	(859) 286-8293
SHU, Sa San	7509 Terry Road	Louisville	KY	40258	(502) 935-8954
SUM, Albert	9812 Linn Station Rd	Louisville	KY	40223	(502) 423-0943
NGURHMINGTHANGA, Benjamin	2710 W Broadway	Louisville	KY	40211	(502) 778-3346
SUM, Patrick	2440 Bardstown	Louisville	KY	40205	(502) 459-9805
SUM, Albert	9812 Linn Station Rd	Louisville	KY	40223	(502) 423-0943
MANG, Cin Go	5533 New Cut Rd.	Louisville	KY	40214	(502) 361-7446
THANG, Cung	12501 Shelbyville Road	Louisville	KY	40243	(502) 244-7957
WANG, Lu	6900 Bardstown Road	Louisville	KY	40291	(502) 239-2115
KAP, Thang Khen	5001 Mud Lane	Louisville	KY	40229	(502) 962-7744
SUM, Albert	9812 Linn Station Rd	Louisville	KY	40223	(502) 423-0943
NGEH, Mi	9080 Taylorsville Rd.	Louisville	KY	40299	(502) 499-6912
SOE, Shein Tayzar	291 North Hubbard Lane #130	Louisville	KY	40207	(502) 895-8308
TAWNG, Brang	9440 Brownsboro Rd.	Louisville	KY	40241	(502) 425-8542
LIAN, Paul Sang	4009 POPLAR LEVEL RD.	LOUISVILLE	KY	40213	(502) 454-3914
SEN, Nem	10010 Ballardsville Rd	Louisville	KY	40241	(502) 357-3505
TAWNG, Brang	9440 Brownsboro Rd.	Louisville	KY	40241	(502) 425-8542
SUM, Albert	9812 Linn Station Rd	Louisville	KY	40223	(502) 423-0943
AYE, Chan	12450 La Gange Road	Louisville	KY	40245	(502) 241-1311
THANG, Pau Khan	12611 TAYLORSVILLE RD.	Louisville	KY	40299	(502) 261-0251
NGURHMINGTHANGA, Benjamin	2710 W Broadway	Louisville	KY	40211	(502) 778-3346
LIAN, Paul Sang	4009 POPLAR LEVEL RD.	LOUISVILLE	KY	40213	(502) 454-3914
WANG, Lu	6900 Bardstown Road	Louisville	KY	40291	(502) 239-2115
NGURHMINGTHANGA, Benjamin	2710 W Broadway	Louisville	KY	40211	(502) 778-3346
SOE, Shein Tayzar	291 North Hubbard Lane #130	Louisville	KY	40207	(502) 895-8308
SHU, Sa San	7509 Terry Road	Louisville	KY	40258	(502) 935-8954
HRE, Ngun Tun	4915 Dixie Highway	Louisville	KY	40216	(502) 448-8215
SHU, Sa San	7509 Terry Road	Louisville	KY	40258	(502) 935-8954
THANG, Pau Khan	12611 TAYLORSVILLE RD.	Louisville	KY	40299	(502) 261-0251
THANG, Thawng	2500 TERRA CROSSING BLVD	LOUISVILLE	KY	40245-5374	(502) 885-7662
THANG, Thawng	2500 TERRA CROSSING BLVD	LOUISVILLE	KY	40245-5374	(502) 885-7662
THANG, Pau Lam	2219 Holiday Manor Court	Louisville	KY	40222	(502) 813-3220
NAI, Chan	300 Kroger Center	Morehead	KY	40351	(606) 784-7529
ZAW, Khant	170 BELLERIVE BLVD	NICHOLASVILLE	KY	40356	(859) 219-1058
ZAW, Khant	170 BELLERIVE BLVD	NICHOLASVILLE	KY	40356	(859) 219-1058
ZAW, Khant	170 BELLERIVE BLVD	NICHOLASVILLE	KY	40356	(859) 219-1058
THAWNG, Nang Deih	1670 Starlite Drive	Owensboro	KY	42301	(270) 926-1607
THAWNG, Nang Deih	1670 Starlite Drive	Owensboro	KY	42301	(270) 926-1607
CEU, Van Lal Lian	5929 Timber Ridge Drive	Prospect	KY	40059	(502) 292-2464
IANG, Saw Za	311 Boone Station Road	Shelbyville	KY	40065	(502) 633-1625
HNING, Gi	185 Adam Shepherd Pkwy	Shepherdsville	KY	40165	(502) 543-7242
SIAM, Lal Nun	50 Stonegate Center	Somerset	KY	42501	(606) 678-0202
SIAM, Lal Nun	50 Stonegate Center	Somerset	KY	42501	(606) 678-0202
SIAM, Lal Nun	50 Stonegate Center	Somerset	KY	42501	(606) 678-0202
CHHAKCHHUAK, Mordecai Zodinliana	212 Kroger Way	Versailles	KY	40383	(859) 873-7704
OO, Tin Su Khine	430 Richwood Rd	Walton	KY	41094	(503) 999-6445
ZIN, Philippo	1661 Bypass Road	Winchester	KY	40391	(859) 745-4959
MANG, Sem Sui	1265 Twining Drive	Barksdale	LA	71110	(318) 456-8263
JANG MAW, Dai Zin	12732 Perkins Road	Baton Rouge	LA	70810	(225) 767-6659
LIAN, Cung Bik	7902 Highway 23	Belle Chasse	LA	70037	(504) 393-1012
KAP, San Za	400 Russell Ave	Belle Chasse	LA	70037	(504) 678-2587
LAL, Khai Suan	7445 LA 467 Bldg 601	Fort Polk	LA	71459	(337) 531-2747
BAWK, Zau	5016 West Esplanade Ave	Metairie	LA	70006	(504) 885-7005
BAWK, Zau	5016 West Esplanade Ave	Metairie	LA	70006	(504) 885-7005

Zenshi Food Service Counters

Franchise List

As of March 31, 2025

Franchisee Name	Address	City	State	Zip	Phone
RALTE, Lai Rem Ruata	801 Harrison Ave.	New Orleans	LA	70124	(504) 293-1201
RALTE, Lai Rem Ruata	801 Harrison Ave.	New Orleans	LA	70124	(504) 293-1201
MASHAW, Mung Dan	2222 St. Claude Ave	New Orleans	LA	70117	(504) 262-8888
THANG, William Ram Kip	5452 Live Oak Centre Drive	St. Francisville	LA	70775	(225) 635-9817
LWIN, Min	175 University Drive	Amherst	MA	1002	(413) 253-0416
GARCHA, Samten Norbu	53 Huntington Ave	Boston	MA	2116	(617) 262-4688
SUNNY, Seng	33 Kilmarnock Street	Boston	MA	2215	(617) 267-4684
SHERPA, Doma	90 Causeway St.	Boston	MA	2114	(857) 409-3403
RAI, Ajay	370 western Ave.	Brighton	MA	2135	(617) 787-5266
TAMANG, Dil Bahadur	49 White St.	Cambridge	MA	2140	(617) 492-5566
RAI, Purna Kala	699 Mt. Auburn Street	Cambridge	MA	2138	(617) 876-1450
RAI, Purna Kala	699 Mt. Auburn Street	Cambridge	MA	2138	(617) 876-1450
SHERPA, Sangye	1 Boylston Street	Chestnut Hill	MA	2467	(617) 232-3854
XU, Han Qing	739 Chief Justice Cushing	Cohasset	MA	2025	(781) 383-2315
MAY, Mya Mya	15 State Rd	Dartmouth	MA	2747	(508) 993-9995
MAY, Mya Mya	15 State Rd	Dartmouth	MA	2747	(508) 993-9995
SHERPA, Angtenjen	45 Morrissey Blvd	Dorchester	MA	2124	(617) 265-1776
TIN, Mimi Htwe	246 Border Street	East Boston	MA	2128	(617) 567-4116
ONG, Naing Ong	441 N Main Street	East Longmeadow	MA	1028	(413) 504-6014
JIANG, Phoebe Bao Qian	348 East Central Street	Franklin	MA	2038	(508) 553-8705
OO, Thu Zar	127 Eastern Ave	Gloucester	MA	1930	(978) 281-4844
OO, Thu Zar	127 Eastern Ave	Gloucester	MA	1930	(978) 281-4844
SUI, Esther	740 Main St	Great Barrington	MA	1230	(413) 528-1314
KO, Aung Ko	237 Mohawk Trail	Greenfield	MA	1301	(413) 772-0435
MOE, Jessica	237 Mohawk Trail	Greenfield	MA	01301	(413) 772-0435
TUAN, Lang Kho	1709A BUILDING - GRIFFISS STREET	HANSCOM AFB	MA	01731-6290	(781) 377-4210
WOSE, Xirao	160 Reservoir St Rt. 31	Holden	MA	1520	(508) 829-9614
CHEN, Ying Meng	182 Summer St.	Kingston	MA	2364	(781) 585-7423
AUNG, Zaw Zaw	10 Pleasant Street	Lee	MA	1238	(413) 504-6037
HLAING, Khin Hsu	802 Williams Street	Longmeadow	MA	1104	(413) 567-6231
AUNG, Chan	45 Veterans Memorial Drive	North Adams	MA	1247	(413) 663-6549
WU, Yong Fan	690 Depot Street	North Easton	MA	2356	(508) 238-0165
ZAW, Win	136 N King Street	Northampton	MA	1060	(413) 584-6137
ZAW, Win	136 N King Street	Northampton	MA	1060	(413) 584-6137
ZAW, Win	136 N King Street	Northampton	MA	1060	(413) 584-6137
ZAW, Win	136 N King Street	Northampton	MA	1060	(413) 584-6137
ZHANG, Ming Zhi	10 Washington Street	Norwell	MA	2061	(781) 681-9322
HTET, Zarni	434 Walpole Street	Norwood	MA	2062	(781) 769-0905
TIN, David	9 West Rd Route 6	Orleans	MA	2653	(508) 240-1021
TIN, David	9 West Rd Route 6	Orleans	MA	2653	(508) 240-1021
KYAW, Kyaw	1180 Thorndike Street	Palmer	MA	1066	(413) 504-6020
KYAW, Kyaw	1180 Thorndike Street	Palmer	MA	1066	(413) 504-6020
LAUNG, Sai	210 Andover St.	Peabody	MA	1960	(978) 532-5434
GAO, Jianchao	200 West St	Pittsfield	MA	1201	(413) 447-7301
LIN, YOU ZHI	130 Granite Street	Quincy	MA	2169	(617) 770-0841
LIN, YOU ZHI	130 Granite Street	Quincy	MA	2169	(617) 770-0841
BRAHMACARIYA, FNU	780 South Main Street	Sharon	MA	2067	(781) 784-5995
CHEN, Melanie Wan	14 McGrath Hwy	Somerville	MA	2143	(617) 625-4070
GYALTSEN, Sherab	25 Robert Dr.	South Easton	MA	2375	(508) 238-6305
TOBZIN TASHI, Fnu	44 Willimansett Street	South Hadley	MA	1075	(413) 538-9303
PAW, Than Tin	10 College Hwy Rt. 10	Southampton	MA	1073	(413) 527-5500
HTOO, Kyaw	505 E. Main Street	Southbridge	MA	1550	(508) 764-6213
THAWNG, Kulh Lian	195 College Highway	Southwick	MA	1077	(413) 569-6163
THAWNG, Kulh Lian	195 College Highway	Southwick	MA	1077	(413) 569-6163
MAUNG, Thandar	62 W. Main Street	Spencer	MA	1562	(508) 885-0003
MAUNG, Thandar	62 W. Main Street	Spencer	MA	1562	(508) 885-0003
JUNGNEY, Yesi	1090 St. James Ave	Springfield	MA	1104	(413) 732-5177
MAUNG, Shan Y	1941 Wilbraham Road	Springfield	MA	1129	(413) 783-9141
MAUNG, Shan Y	1941 Wilbraham Road	Springfield	MA	1129	(413) 783-9141
JUNGNEY, Yesi	1090 St. James Ave	Springfield	MA	1104	(413) 732-5177
JUNGNEY, Yesi	1090 St. James Ave	Springfield	MA	1104	(413) 732-5177
HTUN, Khin Htike Htike	1500 Main Street	Springfield	MA	1115	(413) 504-1278
LIN, Kyaw Htin	1111 Providence Hwy	Walpole	MA	2081	(508) 660-9710
LIN, Kyaw Htin	1111 Providence Hwy	Walpole	MA	2081	(508) 660-9710
GURUNG, Asha	1070 Lexington St.	Waltham	MA	2451	(781) 891-0615
GURUNG, Asha	1070 Lexington St.	Waltham	MA	2451	(781) 891-0615
SHWE, Thanda	637 Lowell St.	West Peabody	MA	1960	(978) 536-3200
HTET, Nyai W	503 Memorial Ave.	West Springfield	MA	1089	(413) 746-0999
MAR, Zin	1 E Silver Street	Westfield	MA	1085	(413) 568-1001
WIN, Aung Myo	475 E Main Street	Westfield	MA	1085	(413) 562-5230
TUN, May	2035 Boston Road	Wilbraham	MA	1095	(413) 543-0931

Zenshi Food Service Counters

Franchise List

As of March 31, 2025

Franchisee Name	Address	City	State	Zip	Phone
YANGDON, Tashi	100 Mayfield St.	Worcester	MA	1602	(508) 793-9011
MADA, William	14 West Boylston St.	Worcester	MA	1605	(508) 852-7670
MYO, Raymond	1684 Starkey Bl.	Andrews AFB	MD	20762	(240) 857-6512
NIKAM, Tuan Cung Ceu	22700 Sweet Shrub Dr.	Clarksburg	MD	20871	(301) 916-7280
WIN, Phyu Phyu	8620 Guilford Rd	Columbia	MD	21046	(410) 290-5902
LIAN, Titus	10125 Ward Rd.	Dunkirk	MD	20754	(443) 550-1581
HLAING, Samuel Ko Ko	28528 MARLBORO AVE	Easton	MD	21601	(410) 690-7203
GYI, Sai Koko	11075 Resort Rd	Ellicott City	MD	21042	(410) 313-8215
THANT, Orion	Building 2786 Mapes & Macarthur Rds	Fort George G Meade	MD	20755	(301) 677-7286
CHAW, Fourkoko	BLDG # 1510 Porter Street	Frederick	MD	21702	(301) 619-4219
OO, Tun	8184 Westside Drive	Fulton	MD	20759	(301) 635-5761
THAWNG, John S Ngun	14702 Baltimore Ave	Laurel	MD	20707	(301) 490-6039
CHHAIHLO, Esther Ngopaw	143 Ritche Hwy N	Severna Park	MD	21146	(410) 544-5450
OO, Min Zaw	600 center Street	Auburn	ME	4210	(207) 784-6971
OO, Min Zaw	600 center Street	Auburn	ME	4210	(207) 784-6971
TUN, Htoo	720 South 11th. Street	Niles	MI	49120	(269) 684-2722
TUN, Htoo	720 South 11th. Street	Niles	MI	49120	(269) 684-2722
NG, Daniel K	2121 Cleveland Ave.	St. Joseph	MI	49085	(616) 983-1223
Lin, Klara	16500 W. 78th St.	Eden Prairie	MN	55346	(952) 937-9585
PAING, Ye Yint	324 Southdale Center	Edina	MN	55435	(651) 796-6098
VANG, Lue	440 Water Street	Excelsior	MN	55331	(952) 229-8300
LEE, Mai Kao	2440 Hennepin Ave.	Minneapolis	MN	55405	(612) 377-3448
LEE, Naicheng Koobtsheej	5327 Lyndale Ave. S.	Minneapolis	MN	55419	(612) 822-2935
LEE, Mai Kao	2440 Hennepin Ave.	Minneapolis	MN	55405	(612) 377-3448
THAO, Keng	5801 Neal Ave. N.	Oak Park Heights	MN	55082	(651) 439-9161
NU, Wai	441 County Highway 96	Shoreview	MN	55126	(651) 313-6868
VANG, Bee	1261 Grand Ave.	St. Paul	MN	55105	(651) 698-3366
PEON, Nyee	4391 South Lake Ave	White Bear Lake	MN	55110	(651) 429-5913
ZAW, Ne Myo	1059 Meadowlands Dr.	White Bear Lk	MN	55127	(651) 426-6534
HER, Rosie	8505 Valley Creek Road	Woodbury	MN	55125	(651) 578-8800
SOUN, Ai Thomas Kua	3900 Vogel Road	Arnold	MO	63010	(636) 282-3377
SOUN, Ai Thomas Kua	3900 Vogel Road	Arnold	MO	63010	(636) 282-3377
SING, Pan Paukhan	8800 Manchster	Brentwood	MO	63144	(314) 961-5454
SING, Pan Paukhan	8800 Manchster	Brentwood	MO	63144	(314) 961-5454
TUANG, Deng	1060 Woodsmill Plaza	Chesterfield	MO	63017	(636) 227-2278
TUANG, Deng	1060 Woodsmill Plaza	Chesterfield	MO	63017	(636) 227-2278
SANGTUALA, James	1729 W Broadway	Columbia	MO	65203	(573) 445-9433
SANGTUALA, James	1729 W Broadway	Columbia	MO	65203	(573) 445-9433
HUALNGO, Michael Kaplianchnunga	1400 Forum Blvd.	Columbia	MO	65203	(573) 446-2800
UK, Nawl	6083 Mid Rivers Mall Dr.	Cottleville	MO	63304	(636) 498-0108
UK, Nawl	6083 Mid Rivers Mall Dr.	Cottleville	MO	63304	(636) 498-0108
UK, Nawl	6083 Mid Rivers Mall Dr.	Cottleville	MO	63304	(636) 498-0108
UK, Nawl	6083 Mid Rivers Mall Dr.	Cottleville	MO	63304	(636) 498-0108
UK, Nawl	6083 Mid Rivers Mall Dr.	Cottleville	MO	63304	(636) 498-0108
MAI, Gui Qing	12756 Olive Street Rd.	Creve Coeur	MO	63141	(314) 434-7323
MAI, Gui Qing	12756 Olive Street Rd.	Creve Coeur	MO	63141	(314) 434-7323
MAI, Gui Qing	12756 Olive Street Rd.	Creve Coeur	MO	63141	(314) 434-7323
MAI, Gui Qing	12756 Olive Street Rd.	Creve Coeur	MO	63141	(314) 434-7323
LATT, Win Tun	12332 Manchester Road	Des Peres	MO	63131	(314) 965-3094
LATT, Win Tun	12332 Manchester Road	Des Peres	MO	63131	(314) 965-3094
THAWNG, Peter Biak	245 East 5th St.	Eureka	MO	63025	(636) 938-4102
KHUAL, Lian	689 Nebraska Ave.	Fort Leonard Wood	MO	65473	(573) 596-0783
NAW, Nangohm Nutawng Tingkang	1801 Missouri Blvd.	Jefferson City	MO	65109	(573) 635-0753
PAE, Kyong	10275 Clayton Rd.	Ladue	MO	63124	(314) 991-0510
NHKUM, Kyaw Lwinoo	1900 First Capital Dr.	St. Charles	MO	63301	(636) 669-1801
MOY, San Jian	10650 Olive Blvd	St. Louis	MO	63141	(314) 567-3838
KIIM, Zam Suan	4333 Butler Hill Road	St. Louis	MO	63128	(314) 894-1227
KIIM, Zam Suan	4333 Butler Hill Road	St. Louis	MO	63128	(314) 894-1227
CIN, Kham Lam	5055 Arsenal	St. Louis	MO	63139	(314) 771-5008
MOY, San Jian	10650 Olive Blvd	St. Louis	MO	63141	(314) 567-3838
LIAN, Deih	1020 Loughborough	St. Louis	MO	63111	(314) 752-5333
KIIM, Zam Suan	4333 Butler Hill Road	St. Louis	MO	63128	(314) 894-1227
CHIN, TinTin Aye	4171 Lindell Blvd	St. Louis	MO	63108	(314) 533-8027
CIN, Kham Lam	5055 Arsenal	St. Louis	MO	63139	(314) 771-5008
CHIN, TinTin Aye	4171 Lindell Blvd	St. Louis	MO	63108	(314) 533-8027
LIAN, Deih	1020 Loughborough	St. Louis	MO	63111	(314) 752-5333
HMJUN, Van Ro	700 Arnold Ave.	Whiteman AFB	MO	65305	(660) 687-5655
AYE, Nanghseng	508 Larcher Blvd	Biloxi	MS	39534	(228) 377-4666
YIN, Nai Ong	323 Simler Blvd Bldg #16 B	Columbus AFB	MS	39710	(662) 434-7109
LIN, Nai Min	1707 CBC Second Street B	Gulfport	MS	39501	(228) 871-2039
VALENTINE, Elizabeth R.	7228 Fourth Ave N	Great Falls	MT	59402	(406) 770-6437

Zenshi Food Service Counters

Franchise List

As of March 31, 2025

Franchisee Name	Address	City	State	Zip	Phone
MYINT, Aung	6999 Jackrabbit Lane	Belgrade	MT	59714	(406) 388-0901
HTAY, Kyaw Win	2334 Central Ave	Billings	MT	59102	(406) 656-8160
TUN, Tun Gyi	1212 Grand Ave	Billings	MT	59102	(406) 245-4118
THAN, Maung Khin	511 Central St.	Billings	MT	59102	(406) 245-0115
TIN, Ye Min Htut	670 Main St.	Billings	MT	59105	(406) 245-8792
TUN, Tun Gyi	1212 Grand Ave	Billings	MT	59102	(406) 245-4118
Htun, Thiha	200 S 23rd St.	Bozeman	MT	59718	(406) 586-4785
Htun, Thiha	200 S 23rd St.	Bozeman	MT	59718	(406) 586-4785
NAING, Maung Than Aung	2500 Massachusetts Ave	Butte	MT	59701	(406) 494-7046
Estorque, Ayesha Gardose	1414 3rd Street NW	Great Falls	MT	59404	(406) 761-6800
FALALIMPA, Karell Ann Buyson Paule	2250 10th Ave South	Great Falls	MT	59405	(406) 727-3700
THANG, Tluang Za Hlei	900 W Idaho Street	Kalispell	MT	59901	(406) 257-7127
THANG, Tluang Za Hlei	900 W Idaho Street	Kalispell	MT	59901	(406) 257-7127
YAL, Maung	2120 W. Park St.	Livingston	MT	59047	(406) 222-1177
SHWE, Tway Tway Soe	1003 E. Broadway Street	Missoula	MT	59802	(406) 549-2351
NAING, Myo	3800 Russell St.	Missoula	MT	59801	(406) 549-1547
NAING, Myo	3800 Russell St.	Missoula	MT	59801	(406) 549-1547
NAING, Myo	3800 Russell St.	Missoula	MT	59801	(406) 549-1547
ZAW, May Pyone	2230 N Reserve St.	Missoula	MT	59808	(406) 728-1116
LEL, Sei Kho	146 S. Shore Route	Polson	MT	59860	(406) 883-2340
WIN, Nyunt	11109 US 15 501 Hwy Ste B 1804	Aberdeen	NC	28315	(910) 692-7029
WIN, Nyunt	11109 US 15 501 Hwy Ste B 1804	Aberdeen	NC	28315	(910) 692-7029
CHIEN, Hon Chang	750 W. Williams St.	Apex	NC	27523	(919) 362-3782
PAR, Ngun Pang	940 US Highway 64 W	Apex	NC	27523	(919) 380-1422
MAN, Vung Zam	1441 Kelly Road	Apex	NC	27502	(919) 303-6200
CUNG, Ral	1830 Hendersonville Road	Asheville	NC	28803	(828) 274-6287
CHEN, Guang	905 South Point Rd.	Belmont	NC	28012	(704) 825-6079
KUAL, Lam Khan	240 Shadowline Dr.	Boone	NC	28607	(828) 262-3319
CUAI, Tin	1620 Blowing Rock Rd	Boone	NC	28607	(828) 263-8126
MAWI, Esther Lalen	2750 S. Church St.	Burlington	NC	27215	(336) 586-1873
SAY, Lah	1230 Holcomb Blvd	Camp Lejeune	NC	28547	(910) 451-5071
SUI, Esther Ngun Duh	1018 Lake Park Blvd N	Carolina Beach	NC	28428	(910) 458-8615
OO, Zaw Lwin	310 N. Greensboro St.	Carrboro	NC	27510	(919) 942-8564
DUH, Tin Za	Mill Creek Shopping Center	Carthage	NC	28327	(910) 246-0710
THANGA, Lal Lian	270 Grande Heights Dr.	Cary	NC	27513	(919) 460-4326
MON, Nai Chan	98 Cornerstone Dr.	Cary	NC	27519	(919) 467-1259
PAR, Kei Than	7145 Okelly Chapel Rd	Cary	NC	27519	(919) 465-9432
OO, Maung Zaw Min	10140 Green Level Church Rd.	Cary	NC	27519-8341	(919) 460-3126
THANG, Tuan Hlei	1151 Tryon Village Drive	Cary	NC	27518	(919) 233-3476
DIKA, Lal Rin	3430 Ten Ten Road	Cary	NC	27518	(919) 387-8272
KIMTEI, Tha Lian	885 Walnut St	Cary	NC	27511	(919) 481-4251
THANGA, Lal Lian	270 Grande Heights Dr.	Cary	NC	27513	(919) 460-4326
POTHIPANRANGSI, Anootsara	1020 Bradford Plaza Way	Cary	NC	27519	(919) 460-2082
MAWI, Sui Nei	3480 Kildaire Farm Road	Cary	NC	27518	(919) 303-4028
LIAN BIK, Cung	425 Emissary Drive	Cary	NC	27519	(919) 388-7201
CEU, Biak	2110 Estes Dr.	Chapel Hill	NC	27514	(919) 933-5700
YI, Hla Hla	116 W. Barbee Chapel Rd.	Chapel Hill	NC	27517	(919) 932-5020
LUAI, Tin Kip	1800 Martin Luther King Jr. Blvd	Chapel Hill	NC	27514	(919) 968-0110
DAWN SUSHI CORPORATION	88 Chatham Downs Dr.	Chapel Hill	NC	27517	(919) 960-0275
NAWL, Sang	4821 Berewick Town Center Dr.	Charlotte	NC	28278	(704) 587-1011
SANG, Paul Van Biak	7823 Colony Rd.	Charlotte	NC	28226	(704) 341-3688
CEU, William Vanbiak	9720 Rea Rd	Charlotte	NC	28277	(704) 752-1013
THANG, Kio Cin	3333 Pineville Matthews Rd.	Charlotte	NC	28226	(704) 544-3340
HNIANG, Ni	10616 Providence Rd.	Charlotte	NC	28277	(704) 849-2776
MUTAW, Kaw	9641 Brookdale Dr.	Charlotte	NC	28215	(704) 599-8449
VUNG, Khup Sian	1227 East Blvd.	Charlotte	NC	28203	(704) 375-5071
LAW, Siu	13000 South Tryon St.	Charlotte	NC	28278	(704) 587-9970
PAU, Thang Lian	5810 Prosperity Church Rd	Charlotte	NC	28269	(704) 875-0993
PAR, No Than	5706 Wyalong Dr.	Charlotte	NC	28227	(704) 545-0229
HUAI, Don	8538 Park Rd.	Charlotte	NC	28210	(704) 552-7212
KAP, Dal Khan	325 W. 6th St.	Charlotte	NC	28202	(704) 332-8479
NAING, Win Thein	112 S. Sharon Amity Rd.	Charlotte	NC	28211	(704) 366-1675
MUNG, Cin Khan	4101 Park Rd.	Charlotte	NC	28209	(704) 523-8106
NAING, Win Thein	112 S. Sharon Amity Rd.	Charlotte	NC	28211	(704) 366-1675
SI, Maung	4100 Carmel Rd.	Charlotte	NC	28226	(704) 542-6228
THANG, Pau Min	16625 Lancaster Hwy	Charlotte	NC	28277	(704) 714-4795
CEU, William Vanbiak	9720 Rea Rd	Charlotte	NC	28277	(704) 752-1013
SI, Maung	4100 Carmel Rd.	Charlotte	NC	28226	(704) 542-6228
SANG, Bawi Hnin	1704 Central Ave	Charlotte	NC	28205	(704) 375-8491
TAKNAN, Cangsavt	1015 Providence Rd.	Charlotte	NC	28207	(704) 338-9100
OO, Myint Myint	8445 Davis Lake Parkway	Charlotte	NC	28269	(704) 597-7014

Zenshi Food Service Counters

Franchise List

As of March 31, 2025

Franchisee Name	Address	City	State	Zip	Phone
MUNG, Cin Khan	4101 Park Rd.	Charlotte	NC	28209	(704) 523-8106
THAN, Khin Maw	11222 Providence Road W	Charlotte	NC	28277	(704) 716-2344
KIM, Esther	2222 South Blvd	Charlotte	NC	28203	(704) 373-2122
KIL, Ni	8120 South Tryon Street	Charlotte	NC	28273	(704) 583-2323
SAN, Ruby	12810 S Tryon St	Charlotte	NC	28273	(704) 587-0339
LIAN, Siang	10110 Benfield Road	Charlotte	NC	28269	(704) 992-6951
HON, Niang Sian	11525 CARMEL COMMONS BLVD	CHARLOTTE	NC	28226	(704) 496-5209
LE, Victor C.	24 Publix Dr	Clayton	NC	27527	(919) 550-2812
JOHN LAL TAN, Thang	4150 Clemmons Rd	Clemmons	NC	27012	(336) 778-1445
UK, Thawng	358 George W. Liles Pkwy N.W.	Concord	NC	28027	(704) 786-2510
U, Bi	9900 Poplar Tent Rd.	Concord	NC	28027	(704) 721-0735
UK, Thawng	358 George W. Liles Pkwy N.W.	Concord	NC	28027	(704) 786-2510
SANG, Mung Kai	5015 Weddington Road	Concord	NC	28027	(704) 795-7127
SANG, Mung Kai	5015 Weddington Road	Concord	NC	28027	(704) 795-7127
SANG, Mung Kai	5015 Weddington Road	Concord	NC	28027	(704) 795-7127
LIAN, Niang Pan	21720 Catawba Ave	Cornelius	NC	28031	(704) 895-5351
Fachhai, Zan Thang	431 Peninsula Dr	Davidson	NC	28036	(704) 892-0597
LIN, Soe	149 Cross Center Dr. Suite 111	Denver	NC	28037	(704) 820-0332
LUAI, Mang	513 Brentwood Rd.	Denver	NC	28037	(704) 483-7152
ZUL, Peter Siang Nawl	1125 West NC 54 Hwy., Ste 401	Durham	NC	27707	(919) 403-0794
LIAN, LAL	1501 Horton Rd.	Durham	NC	27705	(919) 471-1938
HTET, Ye	2107 Hillsborough Rd	Durham	NC	27705	(919) 286-1500
Mang, Ji Remmawi	202 NC-54	Durham	NC	27713	(919) 361-9893
SAILO, Biakhnuna	3457 Hillsborough Rd.	Durham	NC	27705	(919) 383-2249
LIAN, Josephlal	5116 N. Roxboro Rd.	Durham	NC	27712	(919) 471-6263
SOE, Nai Hlaing	1802 North Pointe Dr	Durham	NC	27705	(919) 220-5761
Ha, Min Thi	1065 Yunus Road	Durham	NC	27703	(863) 688-1188
MON, Ban Yar	8800 Crew Drive	Emerald Isle	NC	28594	(252) 354-2104
PHYU, Naw Htar	3050 Traemoor Village Dr.	Fayetteville	NC	28306	(910) 424-3505
MOO, Ku	3114 Raeford Rd.	Fayetteville	NC	28303	(910) 321-0114
PAW, Naw Ka Nyaw	3571 Butner Rd	Fort Bragg	NC	28307	(910) 396-2316
KANG, Maro	1017 Canopy Lane	Fort Bragg	NC	28310	(910) 853-7333
LIAN, Centenary Diamond Medal	1371 E. Broad St.	Fuquay-Varina	NC	27526	(919) 567-7423
KHAING, Aye Aye	3350 Robinwood Rd	Gastonia	NC	28054	(704) 524-3590
Sang, Cung Nung	1949 Hoffman Road	Gastonia	NC	28054	(704) 853-7000
BIGJAHONGSAR, Lyah Non	2120 Wayne Memorial Dr.	Goldsboro	NC	27534	(919) 734-3534
SINT, Than Than	701 Francis King St.	Greensboro	NC	27410	(336) 856-8140
MUANA, Lal Rin	5710 High Point Rd.	Greensboro	NC	27407	(336) 854-4050
HUM, Andrew	401 Pisgah Church Rd.	Greensboro	NC	27455	(336) 545-0236
MUANA, Lal Rin	5710 High Point Rd.	Greensboro	NC	27407	(336) 854-4050
FEL, Lal Dik	4010 Battleground Ave.	Greensboro	NC	27410	(336) 288-2203
PAR, Sui Rem	1605 New Garden Rd.	Greensboro	NC	27410	(336) 855-9095
RUATA, Lal Rem	2639 Lawndale Dr	Greensboro	NC	27408	(336) 545-1354
THAWN, Thang Lam	6029 W. Gate City Blvd.	Greensboro	NC	27407	(336) 894-2591
SAM ZA, David	2120 E. Fire Tower Rd.	Greenville	NC	27858	(252) 355-0125
SAM ZA, David	2120 E. Fire Tower Rd.	Greenville	NC	27858	(252) 355-0125
BOY, Nehemiah	705 Greenville Blvd SE	Greenville	NC	27858	(252) 756-4682
DEEBAING, Khamlum	203 Alston Blvd.	Hampstead	NC	28443	(910) 329-0711
KIM, Gin Khan	2765 NC Hwy 210 E	Hampstead	NC	28443	(910) 329-1000
LIAN, Ni Ceu	12190 University City Blvd	Harrisburg	NC	28075	(704) 454-9905
WAH, Naw Eh	Roosevelt Blvd. E Street	Havelock	NC	28533	(252) 466-0802
BAWI, Lian Cung	636 Spartanburg Hwy	Hendersonville	NC	28792	(972) 480-1190
CHIN, Ruby Sui Tha	635 Market Village	Hendersonville	NC	28792	(828) 694-4440
PAING, William	36 29th Ave NorthEast	Hickory	NC	28601	(828) 322-3675
LAMUNG, Jessica Dumdaw	2005 N Main Street	High Point	NC	27262	(336) 905-8610
HLAING, Myint Ko	5277 Sunset Lake Rd.	Holly Springs	NC	27540	(919) 363-3059
SORN, Nai Ong Layi	324 Village Walk Dr.	Holly Springs	NC	27540	(919) 552-1596
Hre, Billy Luai	9925 Rose Commons Dr.	Huntersville	NC	28078	(704) 875-9703
AUNGCHIT, Saw Shwe Hlahtun	7715 Regency Park Dr.	Huntersville	NC	28078	(704) 892-1197
AUNGCHIT, Saw Shwe Hlahtun	7715 Regency Park Dr.	Huntersville	NC	28078	(704) 892-1197
Moe, Tin Tin	15010 Village Crossing Road	Huntersville	NC	28078	(704) 977-0021
WIN, Ko Swe	6610 OLD MONROE RD	Indian Trail	NC	28079	(704) 289-1156
WIN, Ko Swe	6610 OLD MONROE RD	Indian Trail	NC	28079	(704) 289-1156
KYAW, Klaw Klay Paw	2001 Marlin Dr.	Jacksonville	NC	28546	(910) 353-0433
THANG, Za Lian Ngung Cung	971 South Main St.	Kernersville	NC	27284	(336) 992-9735
SHWE, Aung Myo Oo	2012 S. Croatan Hwy	Kill Devil Hills	NC	27948	(252) 449-9191
SWE, Than Than	1530 North Croatan Hwy	Kill Devil Hills	NC	27948	(252) 255-5006
JEROME, Saw	5400 North Croatan Hwy #A	Kitty Hawk	NC	27949	(252) 261-1931
JEROME, Saw	5400 North Croatan Hwy #A	Kitty Hawk	NC	27949	(252) 261-1931
KYI, Le Le	2021 Old Regent Way	Leland	NC	28451	(910) 371-3944
Tluanga, Joseph Lalzui	1615 Providence Road South	Marvin	NC	28173	(704) 843-0119

Zenshi Food Service Counters

Franchise List

As of March 31, 2025

Franchisee Name	Address	City	State	Zip	Phone
HTAY, Hninuu	7800-J, Stevens Mill RD	Matthews	NC	28104	(704) 882-2749
HTAY, Hninuu	7800-J, Stevens Mill RD	Matthews	NC	28104	(704) 882-2749
LIU, James Zhi Yan	1811 Matthews Township Pkwy.	Matthews	NC	28105	(704) 846-7117
CING, Khawl Za	1351 Chestnut Lane	Matthews	NC	28104	(704) 234-0405
REM, Ngun Zung	15080-P Idlewild Rd	Matthews	NC	28104	(704) 882-2277
MANG, Nang	3110 Fincher Farm Road	Matthews	NC	28105	(704) 814-6001
MANG, Nang	3110 Fincher Farm Road	Matthews	NC	28105	(704) 814-6001
KHUP, Huat Za	7036 Brighton Park Dr	Mint Hill	NC	28227	(704) 545-3281
SUI, Biak Mi	5132 Old Charlotte Hwy	Monroe	NC	28110	(704) 289-6598
OO, Saw Peter	134-11 Town Center Dr.	Mooresville	NC	28117	(704) 799-1066
SOE, Saw Soe	118 Argus Lane	Mooresville	NC	28117	(704) 799-2004
SOE, Saw Soe	118 Argus Lane	Mooresville	NC	28117	(704) 799-2004
KHAI, Do Suan	631 Brawley School Road	Mooresville	NC	28117	(704) 660-6800
BACKHAM, Smith	4093 Davis Dr.	Morrisville	NC	27560	(919) 380-0354
NOUNG, Saw Noun	Harris Teeter, 2032 Waterscape Way	New Bern	NC	28562	(252) 631-5226
TUN, Myint Myint	2004 South Glenburnie Road	New Bern	NC	28562	(252) 634-1646
MANG, Langh Kim	5003 E Oak Island Dr.	Oak Island	NC	28465	(910) 278-6785
HAM, Van Ceu	1560 Market Place Blvd	Ocean Isle Beach	NC	28469	(910) 393-2059
SIKE, Nai	3201 Edwards Mill Rd.	Raleigh	NC	27612	(919) 781-8776
CEM, Tluang	13210 Strickland Rd.	Raleigh	NC	27613	(919) 676-3534
SOE, Zaw Min	8101 Fayetteville Rd.	RALEIGH	NC	27518	(919) 772-0241
AYE, Naw A	2603 Glenwood Ave	Raleigh	NC	27608	(919) 787-5526
LWIN, Maung Maung	5550 Creedmoor Rd.	Raleigh	NC	27612	(919) 787-1364
HTAY, Zaw Min	6024 Falls Of Neuse Rd.	Raleigh	NC	27609	(919) 872-5786
KI, Lai Mang	14520 John Rex Blvd	Raleigh	NC	27614	(919) 554-4167
HTAY, Zaw Min	6024 Falls Of Neuse Rd.	Raleigh	NC	27609	(919) 872-5786
LWIN, Maung Maung	5550 Creedmoor Rd.	Raleigh	NC	27612	(919) 787-1364
HNEI, Sui	9640 Leesville Rd	Raleigh	NC	27613	(919) 848-3480
VENG, Lal Than	417 W Peace St	Raleigh	NC	27603	(919) 755-5444
LWIN, Maung Maung	5550 Creedmoor Rd.	Raleigh	NC	27612	(919) 787-1364
JOHNSON, Chuvee Kawhtoolei	3679 Sunset Ave	Rocky Mount	NC	27804	(252) 937-2535
PAO, Hem Len	850 Jake Alexander Blvd W	Salisbury	NC	28144	(704) 633-1658
MOLO, Podah S	1310 Edwards St.	Seymour Johnson AFB	NC	27534	(919) 722-0321
AUNG, Kyaw	134 Venture Lane	Statesville	NC	28625	(704) 878-4073
SUE, Helen	3638 Rogers Rd.	Wake Forest	NC	27587	(919) 562-9521
KHAWNG, Joseph	13686 Capital Blvd	Wake Forest	NC	27587	(919) 554-3608
THAR, VAN L	1030 Forestville Road	Wake Forest	NC	27587	(919) 556-6671
KIM, Sun Nam	8157 Kensington Dr.	Waxhaw	NC	28173	(704) 243-1238
PAR, Ni Hluan	165 Weaver Blvd	Weaverville	NC	28787	(828) 658-1020
PAR, Ni Hluan	165 Weaver Blvd	Weaverville	NC	28787	(828) 658-1020
NYUNT, Hein Zaw	5920 Caroline Beach Rd.	Wilmington	NC	28412	(910) 796-3091
LIN, Popwe	820 S. College Rd.	Wilmington	NC	28403	(910) 452-9242
TUN, Nay Myo Han	8260 Market Street	Wilmington	NC	28411	(910) 681-0571
AYE, Ma Myat Myat	6805 Parker Farm Dr.	Wilmington	NC	28405	(910) 256-1071
THAWM, Ngun	1940 Eastwood Rd.	Wilmington	NC	28403	(910) 256-2015
ZAW, Maung Maung	2800 S College Road	Wilmington	NC	28412	(910) 791-4505
MOO, Eh	716 Bragg Drive	Wilmington	NC	28412	(910) 313-2201
THANG, Peter Hrang Lian	7144 Market Street	Wilmington	NC	28411	(910) 681-3555
SAY, Pa Aye	3401 Raleigh Road Parkway	Wilson	NC	27896	(252) 206-0831
LIANA, Hrang	2835 Reynolda Rd.	Winston Salem	NC	27106	(336) 761-0734
VENA, Van Lal	150 Grant Hill Lane	Winston-Salem	NC	27104	(336) 245-0467
VENA, Van Lal	150 Grant Hill Lane	Winston-Salem	NC	27104	(336) 245-0467
THANGI, Lal Chhuan	422 South Stratford Rd.	Winston-Salem	NC	27103	(336) 723-2305
THANT, Myo Kyaw	2281 Cloverdale Ave.	Winston-Salem	NC	27103	(336) 777-1075
REBECCA, Naw	5365 Robinhood Village Dr.	Winston-Salem	NC	27106	(336) 923-2441
CIN, Sian Kip	34 Miller Street	Winston-Salem	NC	27104	(336) 724-3707
CIN, Sian Kip	34 Miller Street	Winston-Salem	NC	27104	(336) 724-3707
Lahkyu, Aung Limarip	5525 ROBIN LARK CIRCLE	Winston-Salem	NC	27106	(800) 242-1227
WIN, Maung Hla	380 Warrior Dr.	Grand Forks AFB	ND	58205	(701) 747-3083
MON, Nai Lawi	360 Missile Ave Bldg 346	Minot AFB	ND	58705	(312) 453-4322
ZEL, Hram	3614 Twin Creek Drive	Bellevue	NE	68123	(402) 292-3992
ZEL, Hram	3614 Twin Creek Drive	Bellevue	NE	68123	(402) 292-3992
KARENG, Roitawng	101 Meyer Ave	Offutt AFB	NE	68113	(402) 294-6783
IANG, Sui Tha	4405 N 72nd St	Omaha	NE	68104	(402) 571-3057
IANG, Dar Chin	12025 West Center Road	Omaha	NE	68144	(402) 334-5290
IANG, Sui Tha	4405 N 72nd St	Omaha	NE	68104	(402) 571-3057
UK, Sang	13250 W Maple Rd	Omaha	NE	68164	(402) 496-9200
SUNG, Bawi Tha Hnem	7312 N 30th St	Omaha	NE	68112	(405) 451-7070
SUNG, Bawi Tha Hnem	7312 N 30th St	Omaha	NE	68112	(405) 451-7070
CEU, Siang	17370 Lakeside Hills Plz	Omaha	NE	68130	(402) 333-2454
HI, Ngun	505 N 155th Plz	Omaha	NE	68154	(402) 498-5717

Zenshi Food Service Counters

Franchise List

As of March 31, 2025

Franchisee Name	Address	City	State	Zip	Phone
UK, Sang	13250 W Maple Rd	Omaha	NE	68164	(402) 496-9200
IANG, Sui Tha	4405 N 72nd St	Omaha	NE	68104	(402) 571-3057
PAU, Mang Siang	300 Main St.	Nashua	NH	3060	(603) 579-6966
PAU, Mang Siang	300 Main St.	Nashua	NH	3060	(603) 579-6966
TUN, Thant Zin	1 Cooper Plaza	Camden	NJ	8103	(856) 207-0542
HTUT, Jeffrey Kaung	3453 Broidy R.	McGuire AFB	NJ	8641	(609) 754-2153
SAZUL, Lian Bik	1300 10th St	Alamogordo	NM	88310	(575) 488-1200
KO, Minn Ko	675 East 10th Street	Alamogordo	NM	88310	(575) 437-5150
SAWKO, Myat	4950 Montgomery N.E.	Albuquerque	NM	87109	(505) 883-8706
OO, Shwe Zin	2801 S. EUBANK BLVD NE	ALBUQUERQUE	NM	87112	(505) 298-7571
WIN, Thin Nandar	11825 Lomas N.E.	Albuquerque	NM	87112	(505) 293-9280
MUNG, Sian Khan	7101 Wyoming Blvd NE	Albuquerque	NM	87109	(505) 821-9655
SAWKO, Myat	4950 Montgomery N.E.	Albuquerque	NM	87109	(505) 883-8706
GABRIEL, Christopher Ngwe Soe	2910 Juan Tabo Blvd NE	Albuquerque	NM	87112	(505) 299-3800
AUGUSTIN, Sa	6200 Coors Blvd NW	Albuquerque	NM	87120	(505) 897-1800
WIN, Thin Nandar	11825 Lomas N.E.	Albuquerque	NM	87112	(505) 293-9280
AUGUSTIN, Sa	6200 Coors Blvd NW	Albuquerque	NM	87120	(505) 897-1800
CEU, Tha	10131 Coors Rd	Albuquerque	NM	87114	(505) 897-3884
GABRIEL, Christopher Ngwe Soe	2910 Juan Tabo Blvd NE	Albuquerque	NM	87112	(505) 299-3800
OO, Khin Thetmar	701 11th Street NW	Albuquerque	NM	87102	(505) 247-8399
CHA, Hoon	7801 Gibson Blvd.	Albuquerque	NM	87117	(505) 846-4902
MOE, Kyaw	415 N Main	Aztec	NM	87410	(505) 334-7334
MOE, Kyaw	415 N Main	Aztec	NM	87410	(505) 334-7334
HLA, Nang	102 Levttow Ave	Cannon AFB	NM	88103	(575) 784-4330
SIAKHEL, Khin Maungthui	202 West Church St.	Carlsbad	NM	88220	(575) 885-2161
LIAN, Joseph Thawng	980 N. U.S Highway 491	Gallup	NM	87301	(505) 722-7620
SAZUL, Ngun Tinlian	2402 North Grimes St.	Hobbs	NM	88240	(575) 392-4514
Mang, Dawt Ceu	751 New Mexico Ave	Holloman AFB	NM	88330	(575) 572-5127
BIK, Ngun Tha	2551 E. Lohman	Las Cruces	NM	88011	(575) 521-9837
MIN, Nyi Nyi	2351 Main Street S.E.	Los Lunas	NM	87031	(505) 865-3313
LIN, Tun Tun	7800 Enchanted Hills	Rio Rancho	NM	87144	(505) 771-7082
LIN, Tun Tun	7800 Enchanted Hills	Rio Rancho	NM	87144	(505) 771-7082
SAZUL, HLAH	1110 S. Main St.	Rosewell	NM	88203	(505) 623-9300
HMUNG, Kep	721 Mechem Drive	Ruidoso	NM	88345	(575) 257-4014
HTIKE, Zin Lin	3542 Zafarano Dr	Santa Fe	NM	87507	(505) 471-2914
HTIKE, Zin Lin	3542 Zafarano Dr	Santa Fe	NM	87507	(505) 471-2914
THANT, Sai Aung	710 A Paseo Del Pueblo Sur	Taos	NM	87571	(575) 758-1250
HNIN, Kam	2582 Idaho St.	Elko	NV	89801	(775) 738-8016
Kim, Sung Ho	7975 Blue Diamond Road	Las Vegas	NV	89178	(702) 614-4221
MIN, TED AUNG	6730 N. Hualapai Way	Las Vegas	NV	89149	(702) 670-4942
LWIN, KyawMyo	475 E Windmill Ln	Las Vegas	NV	89123	(702) 896-7544
LWIN, KyawMyo	475 E Windmill Ln	Las Vegas	NV	89123	(702) 896-7544
TUN, Aung Min	4200 Mountain Home St	Nellis AFB	NV	89191	(702) 632-5500
HUANG, Liping	1031 Steamboat Parkway	Reno	NV	89521	(775) 332-0910
PHAWT, Naw Ail	5150 Mae Anne Ave.	Reno	NV	89523	(775) 746-9000
HLAING, Theingi Soe	2858 Vista Blvd.	Sparks	NV	89434	(270) 352-8470
LWIN, Nu Nu	115 White Ave	Brooklyn	NY	11252	(718) 630-4960
TIN HLA, Kyu Kyu Mar	1740 SHERIDAN DRIVE	BUFFALO	NY	14223	(716) 874-4991
Win, Pwint Su Wai	65 GREY STREET	EAST AURORA	NY	14052	(716) 655-3206
MYINT, Zaw Zaw	10730 C Enduring Freedom Dr.	Fort Drum	NY	13602	(315) 772-7457
Kyaw, Saw Zaw Hla	2140 Grand Island Blvd	Grand Island	NY	14072	(716) 775-1138
MYINT, Khaing Maung	6150 SOUTH PARK AVE	HAMBURG	NY	14075	(716) 515-3300
MYINT, Khaing Maung	6150 SOUTH PARK AVE	HAMBURG	NY	14075	(716) 515-3300
TUN, Zaw Lin	5827 S Transit Road	Lockport	NY	14094	(585) 324-5565
TUN, Zaw Lin	5827 S Transit Road	Lockport	NY	14094	(585) 324-5565
LIAN, Mang	7200 Niagara Falls Blvd	Niagara Falls	NY	14304	(716) 513-2200
LIAN, Mang	7200 Niagara Falls Blvd	Niagara Falls	NY	14304	(716) 513-2200
LIAN, Biak Za	19 J.F. King Drive	Saratoga Springs	NY	12866	(518) 581-2181
WIN, Zinmar Phyu	Bldg #1200	West Point	NY	10996	(845) 938-3663
Mang, Van Tawk	2130 Sycamore St.	Dayton	OH	45433	(937) 257-3592
PAR, Van Duh	40 Acme St	Marietta	OH	45750	(740) 374-5855
PAR, Van Duh	40 Acme St	Marietta	OH	45750	(740) 374-5855
OO, Thant Zin	205 S 1st St	Altus	OK	73523	(580) 481-7397
MANG, Vungh Mung	1719 Macomb Road	Fort Sill	OK	73503	(580) 442-2305
PU, Tuang	3250 Air Depot Blvd	Tinker AFB	OK	73145	(405) 734-5965
LI, Yafei	585 Siskiyou Blvd	Ashland	OR	97520	(541) 482-7777
AUNG, Aung Ko-Lwin	3250 Leif Erickson Drive	Astoria	OR	97103	(503) 338-2960
AUNG, Aung Ko-Lwin	3250 Leif Erickson Drive	Astoria	OR	97103	(503) 338-2960
KHUP, Lang Khan	11425 SW Beavrtn-Hillsdale Hwy	Beaverton	OR	97005	(503) 526-1800
WONGSOMADI, Budhiman	15995 SW Walker Rd.	Beaverton	OR	97006	(503) 690-5800
PAU, Zam Lam	14555 SW Teal Blvd.	Beaverton	OR	97007	(503) 590-9755

Zenshi Food Service Counters

Franchise List

As of March 31, 2025

Franchisee Name	Address	City	State	Zip	Phone
YUTJAROEN, Daungporn	2650 NE Hwy 20	Bend	OR	97701	(541) 383-6500
YUTJAROEN, Daungporn	2650 NE Hwy 20	Bend	OR	97701	(541) 383-6500
PIANG, Nang Muan	12032 S.E. Sunnyside Rd.	Clackamas	OR	97015	(503) 698-1121
DAHKUM, Deezi	5270 SW Philomath	Corvallis	OR	97333	(541) 738-2100
VATH, Linda	60 Division Avenue	Eugene	OR	97404	(541) 461-1400
WAI, Thet	1500 Coburg Rd.	Eugene	OR	97401	(541) 685-8873
RAM, Phong	145 E. 18th Avenue	Eugene	OR	97401	(541) 485-5051
TONG, Yaxin	1101 Grants Pass Pkwy	Grants Pass	OR	97526	(541) 474-7200
MAHKAW, Yaw Htung	888 NE 25th Ave	Hillsboro	OR	97124	(503) 681-8927
PIANG, Dal Sian	6495 SE Tualatin Valley Hwy	Hillsboro	OR	97123	(503) 848-4550
CING, Don Khan	22075 NW Imbrie Drive	Hillsboro	OR	97124	(503) 747-1100
THU, Aung Mway	2249 Cascade Ave.	Hood River	OR	97031	(541) 386-1841
SING, Khai Muan	4990 river Rd North	Keizer	OR	97303	(503) 390-8810
LIAN, Thang Thang	2655 Shasta Way	Klamath Falls	OR	97603	(541) 884-1086
KIM, Zen Don	401 A Ave.	Lake Oswego	OR	97034	(503) 675-4480
CINGH, Dim Lun	17779 Lower Boones Ferry Rd.	Lake Oswego	OR	97035	(503) 675-2500
PIANG, Kam Hau	615 SW Keck Drive	McMinnville	OR	97128	(503) 474-1087
LU, Lucy	2424 Crater Lake Hwy	Medford	OR	97504	(541) 779-6158
MUSSER, Zoie	1301 Center Dr.	Medford	OR	97501	(541) 857-4650
NAULAK, Gin Pian Sang	14840 SE Webster Rd.	Milwaukie	OR	97267	(503) 303-1071
CIN GO KAP, Mark	1525 West Main St	Molalla	OR	97038	(503) 829-4848
LAI, Hau Nuam	3300 Portland Rd. Suite 100	Newberg	OR	97132	(503) 537-1358
CHENNI, Nadda A.	150 NE 20th St	Newport	OR	97365	(541) 265-4581
MAW, Saw Myat	13434 Colton Place	Oregon City	OR	97045	(503) 655-8155
HAU, Kap Suan	7555 SW Barbur Blvd.	Portland	OR	97219	(503) 452-3000
CHI, Hong Cheng	3805 SE Hawthorne Blvd.	Portland	OR	97214	(503) 872-3300
PIANG, Nang Kam	7404 Interstate Ave	Portland	OR	97217	(503) 286-6751
PIANG, Nang Kam	7404 Interstate Ave	Portland	OR	97217	(503) 286-6751
AUNG, Htay	7700 SW Beavertn-Hillsdale Hwy	Portland	OR	97225	(503) 292-0731
WIN, Me Me	100 NW 20th Pl.	Portland	OR	97209	(503) 228-4821
SUAN, Khup Thang	3030 NE Weidler St	Portland	OR	97232	(503) 280-1308
AUNG, Htay	7700 SW Beavertn-Hillsdale Hwy	Portland	OR	97225	(503) 292-0731
MOE, Aye T	6901 N.E. Sandy Blvd	Portland	OR	97213	(503) 280-1200
OO, Myint	15570 SW PACIFIC HWY	PORTLAND	OR	97224	(503) 598-6001
LWIN, Zaw Min	4515 SE Woodstock	Portland	OR	97206	(503) 788-7600
KHO, Rustum M	13485 N.W Cornell Rd.	Portland	OR	97229	(503) 350-2080
SANG, Zam Lam	3930 S.E. Powell	Portland	OR	97202	(503) 772-4440
OO, Myint	15570 SW PACIFIC HWY	PORTLAND	OR	97224	(503) 598-6001
HONGSA, Nai	1010 S.W. Jefferson St.	Portland	OR	97201	(503) 205-1849
OO, Shine K	1303 NW Lovejoy	Portland	OR	97209	(503) 205-6746
THANG, Hau Lian	2800 S.E. Hawthorne Street	Portland	OR	97214	(503) 236-7070
PAU, Nang Khan	8145 SW Barbur Blvd	Portland	OR	97219	(503) 452-6068
CHAN, Phally Khon	929 NW Garden Valley Blvd	Roseburg	OR	97470	(541) 957-3034
HLAING, Khaing Tun	3450 Commercial St. S.E.	Salem	OR	97302	(503) 585-7663
NAING, Nyi	1455 Edgewater NW	Salem	OR	97304	(503) 365-2170
AYE, Tun Tun	51501 S. Columbia River Hwy	Scappoose	OR	97056	(503) 543-4508
DENG, Feng Juan	401 S. Roosevelt	Seaside	OR	97138	(503) 738-4700
OO, Aung Ye	5755 Main St.	Springfield	OR	97478	(541) 746-1653
CIANG, Kim Khan	14300 SW Barrows Rd	Tigard	OR	97223	(503) 590-0543
AUNG, Marry	11565 SW Pacific Highway	Tigard	OR	97223	(503) 293-7061
CIANG, Kim Khan	14300 SW Barrows Rd	Tigard	OR	97223	(503) 590-0543
LAITHANG, Yenaing	25691 SE Stark Street	Troutdale	OR	97060	(503) 667-1722
THANG, Cin Lam	19200 SW Martinazzi Ave	Tualatin	OR	97062	(503) 691-4208
TOO, Too	22000 Salamo Road	West Linn	OR	97068	(503) 650-8954
Qi, Qi	8255 SW Wilsonville Road	Wilsonville	OR	97070	(503) 682-9053
SANG, Guowet Willie	689 N Terminal Road	Fort Buchanan	PR	00934-4576	(787) 707-2078
LYNN, Tin	186 County Rd	Barrington	RI	2806	(401) 245-5882
HTUN, Sai Swan	1163 Whipple St.	Newport	RI	2841	(401) 841-2111
AUNG, Myo Nyunt	1795 Whiskey Rd	Aiken	SC	29803	(803) 642-5280
NAWL, Za	250 Eastgate Dr.	Aiken	SC	29803	(803) 643-7970
NAWL, Za	250 Eastgate Dr.	Aiken	SC	29803	(803) 643-7970
VUNG, Ngun	1611 E. Greenville St.	Anderson	SC	29621	(864) 231-5240
DIK, Joseph Tan	3801 E. Clemson Blvd	Anderson	SC	29621	(864) 231-1170
BEN, Reu	1284 Knox Ave	Augusta	SC	29841	(803) 442-4500
BAWILIANSANG, James	33 Robert Smalls Pkwy	Beaufort	SC	29906	(800) 242-1227
LIAN, Zam Biak	125 Towne Dr.	Bluffton	SC	29910	(843) 815-6070
WANG, Huaxin	27 Discovery Drive	Bluffton	SC	29910	(843) 989-7022
MANG, Thio	80 Baylor Dr.	Bluffton	SC	29910	(843) 706-3049
RAM, Uk Thang	101 Buckwalter Place Blvd	Bluffton	SC	29910	(843) 815-6430
MANG, Thio	80 Baylor Dr.	Bluffton	SC	29910	(843) 706-3049
REM, Ngun Hlei	2501 May River Crossing	Bluffton	SC	29910	(843) 815-3800

Zenshi Food Service Counters

Franchise List

As of March 31, 2025

Franchisee Name	Address	City	State	Zip	Phone
PAN, Ja Seng	1235 Chapin Road	Chapin	SC	29036	(803) 345-7536
THWIN, Myo	675 Folly Rd.	Charleston	SC	29412	(843) 406-8977
TUNE, Joseph	290 East Bay St.	Charleston	SC	29401	(843) 722-6821
SENG, Ah Ba	975 Savannah Hwy Suite 135	Charleston	SC	29407	(843) 556-5351
PENG, Tluang	1812 Sam Rittenberg Blvd	Charleston	SC	29407	(843) 763-7283
SANG, Biak	1985 Folly Rd.	Charleston	SC	29412	(843) 762-6255
ZAW, Khoung Htut	1739 Maybank HWY	Charleston	SC	29412	(843) 795-9091
THWIN, Myo	675 Folly Rd.	Charleston	SC	29412	(843) 406-8977
HAN, Khun Thar Min	1401 Sam Rittenberg Blvd	Charleston	SC	29407	(843) 852-3350
PENG, Za	520 Folly Rd	Charleston	SC	29412	(843) 762-5670
ZHENG, Mei Feng	10 Westedge St. Ste 100	Charleston	SC	29403	(843) 720-7000
PENG, Za	520 Folly Rd	Charleston	SC	29412	(843) 762-5670
MADONGTEI, Rebecca	103 Lawson Drive	Charleston AFB	SC	29404	(843) 963-7469
MADONGTEI, Rebecca	103 Lawson Drive	Charleston AFB	SC	29404	(843) 963-7469
BIAKKOONG, Hilda langhnmaw	730 Hopewell Dr.	Charleston-Berkeley	SC	29492	(843) 856-5193
HOI, Bual Kip	1390 Tiger Blvd	Clemson	SC	29631	(864) 654-3776
HRANG, Lian	1028 Roberts Branch Pkwy	Columbia	SC	29203	(803) 234-7130
SUN, Kyu Kyu	2800 Rosewood Dr.	Columbia	SC	29205	(803) 806-8839
THAWNG, Chan Lian	10128 Two Notch Rd.	Columbia	SC	29223	(803) 788-9484
THANG, Siang Hnin	4611 Hard Scrabble Rd.	Columbia	SC	29229	(803) 699-8131
RING ZAI, Thang Ci	2732 North Lake Dr.	Columbia	SC	29212	(803) 407-2216
AUNG, Zaw Win	501 Gervais St.	Columbia	SC	29201	(803) 255-4351
THANG, Siang Hnin	4611 Hard Scrabble Rd.	Columbia	SC	29229	(803) 699-8131
HLAWNMUAL, Sarah Vansuipar	6525 Calhoun Memorial Hwy	Easley	SC	29640	(864) 850-2270
LAI, Maung	1930 W Palmetto Street	Florence	SC	29501	(843) 678-9525
MANG, Biak	4716 Commissary Way	Fort Jackson	SC	29207-6060	(803) 751-5789
MUNG, Pau Khat	1750 Hwy 160 West	Fort Mill	SC	29708	(803) 396-0440
CEU, Tluang	500 Mercantile Place	Fort Mill	SC	29715	(803) 547-0520
KIM, Lal Ruat	867 Stockbridge Dr.	Fort Mill	SC	29708	(803) 548-6612
MOE, Nan Aye Thidar	928 Gold Hill Rd.	Fort Mill	SC	29708	(419) 782-0950
WARNOCK, Merry L.	208 Saint James Ave Ste C	Goose Creek	SC	29445	(843) 569-7920
MAWI, Ram Nei	1750 Woodruff Rd	Greenville	SC	29607	(864) 987-7080
NEI, Van Pek	235 S. Pleasantburg Dr.	Greenville	SC	29607	(864) 250-4700
MAWI, Lal Nei	215 Pelham Rd.	Greenville	SC	29615	(864) 370-8210
THLUI, Mang Men	5000 Old Buncombe Rd Unit 15	Greenville	SC	29617	(864) 294-4430
SANG, SAMUEL	479 Bypass 72 NW	Greenwood	SC	29649	(864) 223-8902
SUI, Mai	411 The Parkway	Greer	SC	29650	(864) 848-7820
KAM, Akam Ral	112 Nickle Plate Road	Hardeeville	SC	29927	(843) 208-3600
SUNG, Dawt Len	310 Main St.	Hilton Head	SC	29926	(843) 689-6255
HMUNG, Lai Zalian	33 Office Park Rd.	Hilton Head	SC	29928	(843) 785-6185
Tuang, Khen Lal	42 Shelter Cove Lane	Hilton Head	SC	29928	(843) 842-0540
HE-SA, Ngun Aung	45 Pembroke Dr.	Hilton Head Island	SC	29926	(843) 689-9977
HE-SA, Ngun Aung	45 Pembroke Dr.	Hilton Head Island	SC	29926	(843) 689-9977
LIN, Jing	8356 Charlotte Hwy.	Indian Land	SC	29707	(803) 548-9000
LIAN, David	7467 St. Andrews Rd. .	Irmo	SC	29063	(803) 732-0423
LIAN, David	7467 St. Andrews Rd. .	Irmo	SC	29063	(803) 732-0423
LIAN, Hong	7320 Broad River Rd	Irmo	SC	29063	(803) 407-0127
LIAN, Hong	7320 Broad River Rd	Irmo	SC	29063	(803) 407-0127
THU, Ma Khin Myo	3642 Savannah Hwy	Johns Island	SC	29455	(843) 573-8734
CUAI, Duhkip	158 Highway 274	Lake Wylie	SC	29710	(803) 831-5667
THAWNG, Za	100 Old Cherokee Rd	Lexington	SC	29072	(803) 951-3999
THAWNG, Za	100 Old Cherokee Rd	Lexington	SC	29072	(803) 951-3999
CANG, Hannah Van Rem	111 W. Butler Rd.	Mauldin	SC	29662	(864) 987-1601
CIN, Nang Van	2830 Hwy 52	Moncks Corner	SC	29461	(843) 761-7741
SUANG, Cin Mung Mun	1220 Ben Sawyer Blvd	Mt Pleasant	SC	29464	(843) 884-4489
KHENGLAWT, Katherine Biakhleizing	920 Houston Northcutt Blvd.	Mt. Pleasant	SC	29464	(843) 881-1983
LIAN, Zuni	620 Long Point Rd.	Mt. Pleasant	SC	29464	(843) 856-4631
MOIA, Zothan	2195 Tea Planter Lane	Mt. Pleasant	SC	29466	(843) 881-2622
MOIA, Zothan	2195 Tea Planter Lane	Mt. Pleasant	SC	29466	(843) 881-2622
KHENGLAWT, Katherine Biakhleizing	920 Houston Northcutt Blvd.	Mt. Pleasant	SC	29464	(843) 881-1983
LIZAMA, Anselmo Lisua	1000 Johnnie Dodds Blvd	Mt. Pleasant	SC	29464	(843) 856-3000
LIZAMA, Anselmo Lisua	1000 Johnnie Dodds Blvd	Mt. Pleasant	SC	29464	(843) 856-3000
CHIN, ZING BOR	1125 Park West Blvd.	Mt. Pleasant	SC	29466-6974	(843) 388-2263
THWE, Yin Yin	11920 Highway 707, Ste. A	Murrells Inlet-Horry	SC	29576	(843) 357-0739
JENSEN, Moses Lungtoem	3735 Renee Drive SC	Myrtle Beach	SC	29579	(843) 236-4212
SANG, Biak Nun	2170 Oakheart Road	Myrtle Beach	SC	29579	(843) 903-4615
AUNG, Kyat Thein	955 Wood Duck Dr.	Myrtle Beach	SC	29577	(843) 293-1012
SANG, Biak Nun	2170 Oakheart Road	Myrtle Beach	SC	29579	(843) 903-4615
LIAN, Thawng	334 E. Martintown Rd.	North Augusta	SC	29841	(803) 441-3900
UK, Phuntin	8409 Dorchester Rd	North Charleston	SC	29420	(843) 767-5970
HIMI, Lal Run	1576 Highway 17 N	North Myrtle Beach	SC	29582	(843) 272-0050

Zenshi Food Service Counters

Franchise List

As of March 31, 2025

Franchisee Name	Address	City	State	Zip	Phone
HIMI, Lal Run	1576 Highway 17 N	North Myrtle Beach	SC	29582	(843) 272-0050
SAILUNG, Alex Lalhansanga	10225 Ocean Highway 17	Pawleys Island	SC	29585	(843) 235-3755
PIANG, Cin En	2750 Celanese Rd.	Rock Hill	SC	29732	(803) 329-6220
THANG, Nang Mun Lian	1735 Heckle Blvd	Rock Hill	SC	29732	(803) 372-6364
THAWN, Cin	2186 Cherry Road	Rock Hill	SC	29732	(803) 366-7500
KHAM, Thawng San	115 Rochester Hwy	Seneca	SC	29678	(864) 885-7055
BIK, Van	531 Shaw Drive	Shaw AFB (Columbia)	SC	29152-5033	(803) 895-1294
PUI, Than Sang	2700 Woodruff Rd.	Simpsonville	SC	29681	(864) 234-3860
PUI, Than Sang	2700 Woodruff Rd.	Simpsonville	SC	29681	(864) 234-3860
THANG, Biak Hu	704 Fairview Rd.	Simpsonville	SC	29680	(864) 962-1030
KIM, Morris Lalruat	1400 West Georgia Road	Simpsonville	SC	29680	(864) 962-1183
KIM, Morris Lalruat	1400 West Georgia Road	Simpsonville	SC	29680	(864) 962-1183
LIAN, Lal Din	1905 East Main St.	Spartanburg	SC	29307	(864) 253-1820
LIAN, Lal Din	1905 East Main St.	Spartanburg	SC	29307	(864) 253-1820
KUNG, Hniang	680 Bacon Bridge Rd.	Summerville	SC	29485	(843) 486-0578
KIP, Thang	9500 Dorchester Rd	Summerville	SC	29485	(843) 875-2524
GACSAADY, Jeremy Jacob	1575 Old Trolley Rd	Summerville	SC	29485	(843) 832-0456
MEN, Hrang Thuai	1585 Central Ave.	Summerville	SC	29483	(843) 832-4017
BIAKKOONG, Tony Ralcungthang	1724 State Rd.	Summerville	SC	29486	(843) 761-3750
SUON, Kunthea	1274 NEXTON PKWY	Summerville	SC	29486	(863) 688-1188
PAR, Lung Hnem	2801 Wade Hampton Blvd.	Taylors	SC	29687	(864) 609-7300
YI, Cho	2120 Mt. Rushmore Road	Rapid City	SD	57701	(605) 348-5125
MAUNG, Than	730 Mountain View Road	Rapid City	SD	57701	(605) 342-8455
LIANPI, Dominic	1606 North Ave	Spearfish	SD	57783	(605) 642-5728
KHAI, Cin Khat	7014 City Center Way	Fairview	TN	37062-9048	(615) 799-3474
THANG, Aung Len	3532 Murfreesboro Road	Antioch	TN	37013	(615) 501-8250
MUNG, Go Za	6690 Nolensville Pike	Brentwood	TN	37027	(615) 941-7640
KYAW, Maung Maung	210 Franklin Road	Brentwood	TN	37027	(615) 377-3690
KHAI, Khen Hau	8105 Moores Lane	Brentwood	TN	37027	(615) 221-9880
SIAMMUNG, Peter Kham	101 Creekside Crossing	Brentwood	TN	37027	(615) 507-1505
MARY, Cingsiandim	10638 Concord Rd.	Brentwood	TN	37027	(615) 941-8871
HIMA, Chan	8644 East Brainerd Road	Chattanooga	TN	37421	(423) 296-1907
HIMA, Chan	8644 East Brainerd Road	Chattanooga	TN	37421	(423) 296-1907
NUAM, Hau Ngaih	400 North Market Street	Chattanooga	TN	37405	(423) 755-7901
LAL, Mang Sian	7326 McCutcheon Rd	Chattanooga	TN	37421	(423) 855-1376
NGA, Laawng	3535 Broad St	Chattanooga	TN	37409	(423) 668-5233
HNIANG, Hrin	2100 Lowes Drive	Clarksville	TN	37040	(931) 906-3510
CEU, Robben	1489 Madison Street	Clarksville	TN	37042	(931) 553-0250
THLUAI, Marry	1771 Madison Street	Clarksville	TN	37043-4990	(931) 551-7031
THANG, Van Za	1490 Tiny Town Rd.	Clarksville	TN	37042	(931) 503-2551
UK, Solomon Pa	920 Highway 76	Clarksville	TN	37043	(931) 358-2257
UK, Soloman	2300 Trenton Road	Clarksville	TN	37040	(931) 553-5067
WAI, NweNwe	635 Paul Huff Parkway NW	Cleveland	TN	37312	(423) 476-4022
WIN, Naing	1202 S James Campbell Blvd	Columbia	TN	38401	(931) 388-9002
THANG, Cin Gen	845 Nashville Highway	Columbia	TN	38401	(931) 381-0263
Thang, Mang Hrin	143 Henslee Drive	Dickson	TN	37055	(615) 446-5186
NO, Mang	2020 Mallory Lane	Franklin	TN	37067	(615) 771-7922
GUITE, Muangpi	411 Whitman Road	Franklin	TN	37064	(615) 472-9860
THANG, Pau Zam	3054 Columbia Ave	Franklin	TN	37064	(615) 794-6506
THANG, Pau Zam	3054 Columbia Ave	Franklin	TN	37064	(615) 794-6506
NO, Mang	2020 Mallory Lane	Franklin	TN	37067	(615) 771-7922
SIAN ZA PAU, Cin	2020 Fieldstone Pkwy	Franklin	TN	37069	(615) 599-1825
TUN, Aung	1021 Riverside Dr.	Franklin	TN	37064	(615) 591-3285
TUANG, Thang Lian	1400 Liberty Pike # 200	Franklin	TN	37067	(615) 591-4061
THANG, Dong Min	5021 Hughes Crossing Blvd.	Franklin	TN	37064	(615) 595-2021
TOMBING, Pau Siankhai	2011 Nashville Pike	Gallatin	TN	37066	(615) 230-3900
DIM, Ciin Go	211 Maharris Drive	Gallatin	TN	37066	(619) 989-9989
KHAI, Zam	1931 Long Hollow Pike	Gallatin	TN	37066	(615) 230-7647
THANG, Napoleon	123 Northcreek Blvd	Goodlettsville	TN	37072	(615) 859-1016
UK, Sum Lian	460 Long Hollow Pike	Goodlettsville	TN	37072	(615) 851-7180
LAL, Thang Khaw	2321 E. Andrew Johnson Hwy	Greeneville	TN	37745	(423) 636-1478
LING PE, Kyaw Soe	1010 Glenbrook Way	Hendersonville	TN	37075	(615) 822-0193
THANG, Helen Par Sin Eng	110 Indian Lake blvd.	Hendersonville	TN	37075	(615) 264-2396
THANG, Helen Par Sin Eng	110 Indian Lake blvd.	Hendersonville	TN	37075	(615) 264-2396
LIN, Khaing	5544 Old Hickory Road	Hermitage	TN	37076	(615) 883-4441
PAR, Zahlawn	4400 Lebanon Pike	Hermitage	TN	37076	(615) 883-3317
GEN, Than Khan	4670 Lebanon Pike	Hermitage	TN	37076	(615) 874-0898
KHUP, Pau Khan	509 N State of Franklin Rd.	Johnson City	TN	37604	(520) 321-1212
NINGNYE, Esther Ja Seng Bu	11656 Parkside Drive	Knoxville	TN	37934	(865) 675-3018
THAWN, Khup	2010 Town Center Blvd	Knoxville	TN	37922	(865) 470-0720
KYAW AYE, Kyaw	2429 University Commons Way	Knoxville	TN	37919	(865) 522-6313

Zenshi Food Service Counters

Franchise List

As of March 31, 2025

Franchisee Name	Address	City	State	Zip	Phone
THANG, Mang Suan	1703 West Main St.	Lebanon	TN	37087	(615) 444-2581
TAI, Tony	445 Highway 109 N	Lebanon	TN	37090	(615) 443-4349
PAR, Dawt Chin	198 FOOTHILLS MALL	MARYVILLE	TN	37801-2310	(800) 242-1227
THAWN, Thang Khat	665 S Mount Juliet Rd.	Mount Juliet	TN	37122	(615) 773-0250
LINN, Zaw	11207 Lebanon Road	Mt. Juliet	TN	37122	(615) 758-4200
INTA, DAVONE VEL	1776 W Northfield Blvd	Murfreesboro	TN	37129	(615) 890-9873
HUAI, Cing	2449 OLD FORT PKWY	Murfreesboro	TN	37128	(615) 904-0365
INTA, DAVONE VEL	1776 W Northfield Blvd	Murfreesboro	TN	37129	(615) 890-9873
NAUNG, Min	2946 SOUTH CHURCH STREET	Murfreesboro	TN	37127	(615) 217-2752
TUN, Naing	2050 Lascassas Pike	Murfreesboro	TN	37130	(615) 907-6223
SANG, Run Cun	4432 Veterans Parkway	Murfreesboro	TN	37128	(615) 648-8500
ENG, Suan	1731 South Rutherford Blvd.	Murfreesboro	TN	37130-5957	(615) 849-4290
NAW, Lum	3415 Memorial Boulevard	Murfreesboro	TN	37129	(615) 849-3669
MANG, Go Ngaih	4175 Franklin Rd.	Murfreesboro	TN	37128	(615) 494-3196
HTUNT, Ohn Y.	2650 New Salem Cove	Murfreesboro	TN	37128	(615) 895-7096
THANG, Mung Vum	5229 VETERANS PKWY	MURFREESBORO	TN	37128-4377	(800) 242-1227
SANHKA, Daww Raka	800 Monroe Street	Nashville	TN	37208	(615) 256-6506
SANG, Van Bawi	2615 Franklin Pike	Nashville	TN	37204	(615) 297-5517
SANHKA, Daww Raka	800 Monroe Street	Nashville	TN	37208	(615) 256-6506
MAWI, Van	7087 Hwy 70 South	Nashville	TN	37221	(615) 662-1330
DABAW, Mai Ra	5713 Edmondson Pike	Nashville	TN	37211	(615) 315-9205
SOE, Salai Min	61 E Thompson Ln	Nashville	TN	37211	(615) 981-8847
THET, John	5705 Charlotte Pike	Nashville	TN	37209	(615) 352-5352
MAWI, Van	7087 Hwy 70 South	Nashville	TN	37221	(615) 662-1330
THET, John	5705 Charlotte Pike	Nashville	TN	37209	(615) 352-5352
SANHKA, Daww Raka	800 Monroe Street	Nashville	TN	37208	(615) 256-6506
DABAW, Mai Ra	5713 Edmondson Pike	Nashville	TN	37211	(615) 315-9205
THANG, David	711 Gallatin Road	Nashville	TN	37206	(615) 226-6880
MUANG, Michael	3410 Gallatin Road	Nashville	TN	37216	(615) 227-5053
SING, Thang Lam	2131 Abbott Martin Rd.	Nashville	TN	37215	(615) 297-7531
MANG, Pum Khan	7604 Hwy 70 South	Nashville	TN	37221	(615) 646-1870
NEM, Luan Sian	15544 Old Hickory Blvd.	Nashville	TN	37211-7329	(615) 331-4912
HAN, Tun Tun	4324 Harding Pike	Nashville	TN	37205	(615) 279-2038
TAANG, Tun Suan	6614 Charlotte Pike	Nashville	TN	37209	(615) 352-1055
THUAN, Aung	2324 Lebanon Pike	Nashville	TN	37214	(615) 884-2665
POU, Lian Kam Nang D.	2223 8th Avenue South	Nashville	TN	37204	(615) 279-9470
PATEL, Jayesh	1010 Charlotte Ave.	Nashville	TN	37203	(615) 259-6072
MANG, Khai Lian	1111 Gallatin Ave	Nashville-Davidson	TN	37206	(615) 226-7100
LING, Cung Ceu	1688 OOLTEWAH RINGGOLD RD, SUITE 100	OOLTEWAH	TN	37363	(800) 242-1227
PIANG, Dal Sawm	2656 Parkway	Pigeon Forge	TN	37863	(865) 774-2032
LIAN, Vung	750 Winfield Dunn Parkway	Sevierville	TN	37876	(865) 429-1734
PAU, Thang Sut	1010 N. Main Street	Shelbyville	TN	37160	(931) 684-0681
CING, Cin Hawm	463 Sam Ridley Pkwy West	Smyrna	TN	37167	(615) 355-8329
CING, Cin Hawm	463 Sam Ridley Pkwy West	Smyrna	TN	37167	(615) 355-8329
SUAN, Tual Khan	661 President Place	Smyrna	TN	37167	(615) 220-1919
CING, Nian Lam	1640 Lee Victory Parkway	Smyrna	TN	37167	(615) 223-9101
CHARERNAM, Tony Kee	4900 Port Royal Road	Spring Hill	TN	37174	(931) 560-2141
MANG, Nang Lam	4935 Columbia Pike	Spring Hill	TN	37174	(615) 302-4068
HMUNG, Tin Za	2600 Memorial Blvd	Springfield	TN	37172	(615) 382-7822
VUNG, Mary Nem Ngaih	4726 Traders Way	Thompsons Station	TN	37179	(615) 791-5346
PIANG, Kam Sian	1600 N. Jackson Street, Suite 340	Tullahoma-Coffee	TN	37388	(931) 455-6032
YUODON, Tsering	510 TN-76E	White House	TN	37188	(615) 672-3175
THLUAI, Siang Nei	453 HWY 76	WHITE HOUSE	TN	37188	(863) 688-1188
BAWI, Van Dawtpeng	4450 Buffalo Gap Road	Abilene	TX	79606	(325) 695-5300
DIM, Bawi Hoi	14280 Marsh Lane	Addison	TX	75001	(972) 241-4532
XU, Demin	985 West Bethany Drive	Allen	TX	75013	(972) 908-3830
HLEI, Thawng	5601 W Amarillo Blvd	Amarillo	TX	79106	(806) 353-6464
YA, Kyaw Thu	2530 South Georgia St.	Amarillo	TX	79101	(806) 468-6000
THAMOTSHU, Paipi	5807 SW 45th #100	Amarillo	TX	79109	(806) 353-9700
MI, Nai S.	3552 South Soncy Road	Amarillo	TX	79119	(806) 467-6800
THAW, Eh Dow	9911 Brodie Lane	Austin	TX	78745	(512) 282-5720
THAW, Eh Dow	9911 Brodie Lane	Austin	TX	78745	(512) 282-5720
THAW, Eh Dow	9911 Brodie Lane	Austin	TX	78745	(512) 282-5720
LWIN, Wai Wai	201 N. 23rd Street	Canyon	TX	79015	(806) 655-2300
HOM, Nang San	1400 Cypress Creek Rd	Cedar Park	TX	78613	(512) 506-9118
HOM, Nang San	1400 Cypress Creek Rd	Cedar Park	TX	78613	(512) 506-9118
HOM, Nang San	1400 Cypress Creek Rd	Cedar Park	TX	78613	(512) 506-9118
THANG, SUI	4000 Glade Road	Colleyville	TX	76034	(817) 354-0505
SANG, Sui	5605 Colleyville Blvd	Colleyville	TX	76034	(817) 577-5020
PENG, Van Tha	106 N. Denton Tap	Coppell	TX	75019	(972) 304-3223
PENG, Van Tha	106 N. Denton Tap	Coppell	TX	75019	(972) 304-3223

Zenshi Food Service Counters

Franchise List

As of March 31, 2025

Franchisee Name	Address	City	State	Zip	Phone
THANG, Bawi Lian	700 N. Denton Tap Road	Coppell	TX	75019	(469) 322-6800
HEI, Nawn	4351 FM 2181	Corinth	TX	76210	(940) 321-4358
KHAM, Simon	320 Casa Linda Plaza	Dallas	TX	75218	(214) 319-7919
HNEM, Ngun Tawk	3757 Forest Lane	Dallas	TX	75244	(972) 241-4426
THAI, Cer	6333 East Mockingbird Ln	Dallas	TX	75214	(214) 824-1265
SHI, Li	10455 N Central Expwy	Dallas	TX	75231	(214) 369-9694
SHI, Li	10455 N Central Expwy	Dallas	TX	75231	(214) 369-9694
KAI, Siang Hlei	5809 E. Lovers Ln.	Dallas	TX	75206	(214) 750-3200
CEU, Siang Uk	7117 Inwood Rd.	Dallas	TX	75209	(214) 352-1781
THAI, Cer	6333 East Mockingbird Ln	Dallas	TX	75214	(214) 824-1265
SHI, Li	10455 N Central Expwy	Dallas	TX	75231	(214) 369-9694
LIAN, Za	3878 Oak Lawn Ave	Dallas	TX	75219	(972) 560-0233
KHAM, Simon	320 Casa Linda Plaza	Dallas	TX	75218	(214) 319-7919
UK, Van Lian	315 S. Hampton Road	Dallas	TX	75208	(214) 331-0160
PAR, Sui Tin	14999 Preston Rd.	Dallas	TX	75254	(972) 789-6950
LIAN, Za	3878 Oak Lawn Ave	Dallas	TX	75219	(972) 560-0233
SUNG, Bawi Tha Chin	4625 Frankford Road	Dallas	TX	75287	(972) 732-6291
SAZUL, Siang Cinlian	200 West Crawford Street	Denison	TX	75020	(903) 463-6076
SAZUL, Siang Cinlian	200 West Crawford Street	Denison	TX	75020	(903) 463-6076
N'HPANG, Mung Awng	2321 West University Drive	Denton	TX	76201	(940) 383-2391
NI, Van	2200 N Yarbrough Dr	El Paso	TX	79925	(915) 591-9477
SANG, Lal Lian	5200 Montana Ave	El Paso	TX	79912	(915) 778-8996
THANG, Henry Zalian	3100 Mesa Street	El Paso	TX	79902	(915) 351-1002
THANG, Biak Ceu	11320 Montwood Dr	El Paso	TX	79936	(915) 855-9761
SAZUL, Myo Aung	5630 N. Desert Blvd	El Paso	TX	79912	(915) 845-5069
THAWNG, Lian Bik	3150 N. Zaragoza Rd.	El Paso	TX	79938	(915) 995-3595
WIN, Tun	7022 North Mesa Street	El Paso	TX	79912	(915) 584-9460
LIAN, Van Peng	10765 Kenworthy	El Paso	TX	79924	(915) 821-2006
MAYIT, Dauhkawng	1620 Pike Rd.	El Paso	TX	79906	(915) 568-6688
WIN, Tun	7022 North Mesa Street	El Paso	TX	79912	(915) 584-9460
WIN, Tun	7022 North Mesa Street	El Paso	TX	79912	(915) 584-9460
WIN, Tun	7022 North Mesa Street	El Paso	TX	79912	(915) 584-9460
WIN, Tun	7022 North Mesa Street	El Paso	TX	79912	(915) 584-9460
WIN, Tun	7022 North Mesa Street	El Paso	TX	79912	(915) 584-9460
CAAN, Sui	4301 Cross Timbers Road	Flower Mound	TX	75028	(972) 691-2084
LIAN, Thla	3800 Long Prairie Road	Flower Mound	TX	75028	(972) 355-4007
KHAI, Emmanuel Hau	85020 Warrior Way & 10th St.	Fort Hood	TX	76544	(254) 287-8025
RAM, Zi	7400 Oakmont Blvd	Fort Worth	TX	76132	(817) 423-9569
SUNG, Nomi Biak Nawn	6308 Lake Worth Blvd	Fort Worth	TX	76135	(817) 237-8124
SUNG, Zung	4400 Western Center Blvd	Fort Worth	TX	76137	(817) 232-2180
SUNG, Kil Hnem	9300 Clifford St.	Fort Worth	TX	76108	(817) 246-3366
SIAM, NANG SIAN	850 E Loop 820	Fort Worth	TX	76112	(817) 451-0306
SUNG, Zung	4400 Western Center Blvd	Fort Worth	TX	76137	(817) 232-2180
SUNG, Zung	4400 Western Center Blvd	Fort Worth	TX	76137	(817) 232-2180
LIAN, Than	3100 S. Hulen St.	Fort Worth	TX	76109	(817) 570-2950
SIAM, NANG SIAN	850 E Loop 820	Fort Worth	TX	76112	(817) 451-0306
SIAM, NANG SIAN	850 E Loop 820	Fort Worth	TX	76112	(817) 451-0306
CHIN, Zerobe Dawt Sung	11411 Coit Rd	Frisco	TX	75035	(972) 377-1800
CHIN, Zerobe Dawt Sung	11411 Coit Rd	Frisco	TX	75035	(972) 377-1800
CHIN, Zerobe Dawt Sung	11411 Coit Rd	Frisco	TX	75035	(972) 377-1800
ZI, Amy Siang	11999 Dallas Parkway	Frisco	TX	75033	(214) 872-1500
HESA, Esther	4268 Legacy Dr.	Frisco	TX	75034	(214) 705-0310
CEM, Dawt	2645 Arapaho Rd	Garland	TX	76044	(972) 495-9807
CEM, Dawt	2645 Arapaho Rd	Garland	TX	76044	(972) 495-9807
HKAWNG, Visit R Dau	5721 Williams Drive	Georgetown	TX	78633	(512) 942-6028
CIAKIP, Tluang Hnin	110 Valiant Street	Goodfellow AFB	TX	76908	(325) 653-2441
TUN, Men	4215 S. Carrier Parkway	Grand Prairie	TX	75052	(972) 266-7050
THANG, Vanlian	13671 Eastlake Blvd	Horizon City	TX	79928	(208) 395-6200
LASHI, Lum Awng	14610 Memorial Drive	Houston	TX	77079	(281) 497-0630
DOI, Htoi San	4800 West Bellfort St.	Houston	TX	77035	(713) 721-0011
LAYMAY, Peter	3131 W. Holcombe Blvd.	Houston	TX	77025	(713) 349-2150
LASHI, Lum Awng	14610 Memorial Drive	Houston	TX	77079	(281) 497-0630
MANG, Peng Uk	2225 Louisiana St.	Houston	TX	77002	(713) 331-1042
AUNG, Nan Thiri	9660 Westheimer Road	Houston	TX	77063	(713) 782-0982
HAN, Soe C.	5161 San Felipe #200	Houston	TX	77056	(713) 964-3150
LASHI, Lum Awng	14610 Memorial Drive	Houston	TX	77079	(281) 497-0630
THANG, Henry	2200 W. Shady Grove Rd.	Irving	TX	75060	(972) 374-5100
THANG, Henry	2200 W. Shady Grove Rd.	Irving	TX	75060	(972) 374-5100
VAN, Solomon	4010 N. MacArthur Blvd.	Irving	TX	75038	(972) 717-9727
THANG, Henry	2200 W. Shady Grove Rd.	Irving	TX	75060	(972) 374-5100
THANG, Henry	2200 W. Shady Grove Rd.	Irving	TX	75060	(972) 374-5100

Zenshi Food Service Counters

Franchise List

As of March 31, 2025

Franchisee Name	Address	City	State	Zip	Phone
HLAWNG CEU, Siang Tin Thai	50001 Bldg	Killeen	TX	76544	(254) 287-6648
AUNG, Myat Kyipyar	2250 Foulois St.	Lackland AFB	TX	78236	(210) 671-2837
WIN, Nwe	3405 50 street	Lubbock	TX	79413	(806) 795-8341
ZEYA, Kyaw	401 Slide Rd,	Lubbock	TX	79416	(806) 796-0330
TIAL, Cer Chin	4205 98th Street	Lubbock	TX	79423	(806) 794-1921
TIAL, Sui Tin	6321 4th Street	Lubbock	TX	79416	(806) 784-1500
THUI, Prescilla	4425 19th Street	Lubbock	TX	79407	(806) 788-2000
MANG, Uk Lian	12815 Indiana Ave	Lubbock	TX	79423	(806) 776-8900
TIAL, Cer Chin	4205 98th Street	Lubbock	TX	79423	(806) 794-1921
MANG, Uk Lian	12815 Indiana Ave	Lubbock	TX	79423	(806) 776-8900
MAI, Seng	980 Hwy 287 North	Mansfield	TX	76063	(817) 453-6770
THANG, Uk Ling	3145 e. Broad St.	Mansfield	TX	76063	(817) 453-6000
CUNG, Graham	6100 W Eldorado Parkway	McKinney	TX	75070	(972) 548-5140
LALRAM, MAWI	3317 N. Midland Drive	Midland	TX	79707	(432) 689-8683
BAU, Zyon	2295 Woodforest Pkwy	N Montgomery	TX	77316	(866) 945-1108
AYE, Khin May	10801 D. STREET BLDG 337	NAS CORPUS CHRISTI	TX	78419	(361) 961-2545
NBAN PA, Ja Mai Lu	1765 Military PKWY	Naval AirStation/JRB	TX	76127	(817) 782-3664
HLEI, Van Tha	2783 Cedar St	Pecos	TX	79772	(432) 755-3150
LIAN, Sung Zi	3100 Independence	Plano	TX	75075	(972) 596-4420
LIAN, Sung Zi	3100 Independence	Plano	TX	75075	(972) 596-4420
LIAN, Sung Zi	3100 Independence	Plano	TX	75075	(972) 596-4420
LIAN, Sung Zi	3100 Independence	Plano	TX	75075	(972) 596-4420
THANG, Cung Lian	1929 Preston Road	Plano	TX	75093	(972) 713-5500
BOR, Iang	770 3rd St West	Randolph AFB	TX	78150	(210) 652-5102
GONZALES, Juan	1380 W. Campbell Rd.	Richardson	TX	75080	(972) 680-6010
CING SEN, Mary	1890 FM 359	Richmond	TX	77469	(281) 238-8231
CING SEN, Mary	1890 FM 359	Richmond	TX	77469	(281) 238-8231
Par, Bawi Hnem	3070 North Goliad Street	Rockwall	TX	75087	(972) 961-9330
MANG, Ngun Lian	6706 Dalrock Rd	Rowlett	TX	75089	(214) 607-0218
MANG, Ngun Lian	6706 Dalrock Rd	Rowlett	TX	75089	(214) 607-0218
MANG, Ngun Lian	6706 Dalrock Rd	Rowlett	TX	75089	(214) 607-0218
PAR, San Zaa	3121 Sunset Drive	San Angelo	TX	76904	(325) 942-6627
LIAN, Van Hmun	130 Community Center Drive	Sheppard AFB	TX	76311	(940) 676-2511
LIAN, Van Hmun	130 Community Center Drive	Sheppard AFB	TX	76311	(940) 676-2511
NI CER CIN, Esther	101 Trophy Lake Dr	Trophy Club	TX	76262	(817) 490-6960
NI CER CIN, Esther	101 Trophy Lake Dr	Trophy Club	TX	76262	(817) 490-6960
PYIT, Thaw Wun	4590 Kell Blvd	Wichita Falls	TX	76309	(940) 691-1471
NUNG, Van Cung	2720 Southwest Park Way	Wichita Falls	TX	76308	(806) 791-8113
HLEI, Zing	921 Westgate Way	Wylie	TX	75098	(972) 429-7840
SAN, Ngun Lin	4045 EAST PONY EXPRESS PRKWY	Eagle Mountain	UT	84005	(801) 756-8383
CIN, Sui	400 bldg 7451 6th St.	Hill AFB	UT	84056	(801) 777-2300
MOE, Willy	915 Red Cliffs Drive	Washington	UT	84780	(435) 628-0424
MOE, Willy	915 Red Cliffs Drive	Washington	UT	84780	(435) 628-0424
SANGLIANA, Thuzar Kyaw	900 Army Navy Dr.	Arlington	VA	22202	(703) 413-7112
KO, Myo Ko	4250 Campbell Ave	Arlington	VA	22206	(703) 379-2003
WIN, Kyaw Shane	42415 Ryan Rd.	Ashburn	VA	20148	(703) 542-8300
LAM, Maung	20070 Ashbrook Commons PLZ	Ashburn	VA	20147	(571) 223-0110
Aung, Wai Wai	43300 Southern Walk Plaza	Ashburn	VA	20148	(703) 723-0842
Aung, Wai Wai	43300 Southern Walk Plaza	Ashburn	VA	20148	(703) 723-0842
THANTSIN, Koko	10438 Bristow Center Drive	Bristow	VA	20136	(703) 257-1367
PILTUN, Ram Lin	22449 SPADEA WAY	CARROLLTON	VA	23314	(800) 242-1227
ZAMI, Eng	13900 Air & Space Museum Pkwy	Chantilly	VA	20151	(571) 649-4070
OO, Aung Myo	25401 East Gate Marketplace Plaza	Chantilly	VA	20152	(703) 722-2126
KING, Kawng	159 Community Dr.	Charlottesville	VA	22911	(434) 872-0010
BUBAN, Bernadette	545 Radford Lane	Charlottesville	VA	22903	(434) 823-1184
ARANA, Mary Grace M.	1400 Kempsville Rd	Chesapeake	VA	23320	(757) 217-0376
ARANA, Mary Grace M.	1400 Kempsville Rd	Chesapeake	VA	23320	(757) 217-0376
THAWNG, Lian Blak	3905 Fair Ridge Drive	Fairfax	VA	22033	(703) 877-0580
HAN, Pyae Phyoe	6351 Columbia Pike	Falls Church	VA	22041	(703) 256-6615
KYAW, James M	6020 Gorgas Road	Fort Belvoir	VA	22060	(703) 806-6371
KYAW, James M	6020 Gorgas Road	Fort Belvoir	VA	22060	(703) 806-6371
KYAW, James M	6020 Gorgas Road	Fort Belvoir	VA	22060	(703) 806-6371
KYAW, James M	6020 Gorgas Road	Fort Belvoir	VA	22060	(703) 806-6371
KYAW, James M	6020 Gorgas Road	Fort Belvoir	VA	22060	(703) 806-6371
KYAW, James M	6020 Gorgas Road	Fort Belvoir	VA	22060	(703) 806-6371
KYAW, James M	6020 Gorgas Road	Fort Belvoir	VA	22060	(703) 806-6371
KYAW, James M	6020 Gorgas Road	Fort Belvoir	VA	22060	(703) 806-6371
KYAW, James M	6020 Gorgas Road	Fort Belvoir	VA	22060	(703) 806-6371
Aung, Sai Win	400 Shop Road (next to PX)	Fort Lee	VA	23801	(804) 765-1483
TUN, Han Win	523 Carpenter Rd.	Fort Myer	VA	22211	(703) 696-3674
TUN, Han Win	523 Carpenter Rd.	Fort Myer	VA	22211	(703) 696-3674
THAN, Myo Min Min	9601 Patriot Hwy	Fredericksburg	VA	22407	(540) 898-6801

Zenshi Food Service Counters

Franchise List

As of March 31, 2025

Franchisee Name	Address	City	State	Zip	Phone
THET, Yamin	5940 PLANK RD.	FREDERICKSBURG	VA	22407	(540) 736-6013
PAN, Meiling	13901 Heathcote Blvd	Gainesville	VA	20155	(703) 754-7736
TUN, Nilar	10250 Staples Mill Rd	Glen Allen	VA	23060	(804) 755-2360
TUN, Nilar	10250 Staples Mill Rd	Glen Allen	VA	23060	(804) 755-2360
SEIN, Oo Khin	9645 W. Broad St	Glen Allen	VA	23060	(804) 965-6303
KYAW, May Thu Zar	12960 Highland Crossing Drive	Herndon	VA	20171	(703) 464-7934
HTAY, Kyaw	51 Spaatz Drive	Langley AFB	VA	23665	(757) 764-7604
CHAN, Thwin Aye	19350 Winmeade Dr.	Lansdowne	VA	20176	(571) 333-2495
MYINT, Thet Htar	10060 Market Circle	Manassas	VA	20110	(703) 257-4685
OO, Wai Yan	12745 Galveston Court	Manassas	VA	20110	(703) 580-0251
LIAN, Paul	6603 Mechanicsville Turnpike	Mechanicsville	VA	23111	(804) 569-3902
HTUT, Zaw	13700 Hull Street Rd.	Midlothian	VA	23112	(804) 739-1160
HTUT, Zaw	13700 Hull Street Rd.	Midlothian	VA	23112	(804) 739-1160
LWIN, Thein	12404 Warwick Blvd.	Newport News	VA	23606	(757) 595-6000
SANG, Ro	7550 Granby St	Norfolk	VA	23505	(757) 558-4145
JON, Simon Bar	179 West Ocean View Ave	Norfolk	VA	23503	(757) 587-0200
KYAW, Khin	1588 Mall Dr	Norfolk	VA	23511	(757) 423-3188
HANA, Marvat Mbrook Adim	2015 Huguenot Rd	North Chesterfield	VA	23235	(804) 799-6465
HANA, Marvat Mbrook Adim	2015 Huguenot Rd	North Chesterfield	VA	23235	(804) 799-6465
HTWE, Tin Moe	3249 Tyre Neck Road	Portsmouth	VA	23703	(757) 483-9235
HTWE, Tin Moe	3249 Tyre Neck Road	Portsmouth	VA	23703	(757) 483-9235
GUTIERREZ, Jhonna Nadonza	Bldg # 350, Scott Center Annex	Portsmouth	VA	23709	(757) 399-7941
ARGUETA DIAZ, Darlin Noel	7035 Three Chopt Rd	Richmond	VA	23226	(804) 288-1070
LAHTAW, Htang Ra	4591 S. Laburnum Ave	Richmond	VA	23231	(804) 226-1915
OO, Sandar Cho	7045 Forest Hill Ave	Richmond	VA	23225	(804) 323-4110
MIN, Myo Myin	3189 GODWIN BLVD	SUFFOLK	VA	23434	(757) 942-6032
HTWE, Thet Maung	3575 Bridge Rd.	Sufford	VA	23435	(757) 947-0230
Malum Khawngteng, Elijah	3333 Virginia Beach Blvd.	Virginia Beach	VA	23452	(757) 631-6750
Malum Khawngteng, Elijah	3333 Virginia Beach Blvd.	Virginia Beach	VA	23452	(757) 631-6750
WIN, Ye	2800 Arctic Ave.	Virginia Beach	VA	23451	(757) 422-4595
LWIN, Aung Toe	2476 Nimmo Pkwy	Virginia Beach	VA	23456	(757) 563-9410
MIN, Wisely	4540 Princess Anne Road	Virginia Beach	VA	23462	(757) 467-4387
MIN, Wisely	4540 Princess Anne Road	Virginia Beach	VA	23462	(757) 467-4387
BLANCO, Thomas Dirk Cinco	2129 General Booth Blvd	Virginia Beach	VA	23454	(757) 427-6220
KHAM, Langh Lian	1180 Amphibious Dr	Virginia Beach	VA	23459	(757) 464-3561
TUN, Nyi Nyi	1300 Oceana Blvd.	Virginia Beach	VA	23454	(757) 428-6401
KYAW, Shwe	2105 Princess Anne Road	Virginia Beach	VA	23456	(757) 721-2396
KO, Tin Ko	530 Fletcher Drive	Warrenton	VA	20186	(540) 349-9500
SAN, Aye Cherry	6485 Centerville Rd	Williamsburg	VA	23188	(757) 903-4350
LOME, Shan	4511 John Tyler Highway	Williamsburg	VA	23185	(757) 941-1680
SAN, Aye Sabal	4660 Monticello Ave	Williamsburg-James	VA	23188	(757) 564-5902
OO, Min Hlaing	570 Shelburne Rd.	Burlington	VT	05403	(802) 860-2255
GYI, Ko	66 Mountain View Dr.	Colchester	VT	5446	(802) 654-7803
GYI, Ko	66 Mountain View Dr.	Colchester	VT	5446	(802) 654-7803
GYI, Maung San Tha	64 Equinox Terrace	Manchester Center	VT	5255	(802) 362-4447
TUN, San Shwe	2 Main St.	Montpelier	VT	5602	(802) 237-7587
TUN, San Shwe	2 Main St.	Montpelier	VT	5602	(822) 237-7587
LIN, Thet Naing	221 W. Heron	Aberdeen	WA	98520	(360) 533-1955
MAWI, Elizabeth Sui	911 11th St.	Anacortes	WA	98221	(360) 293-5393
MAWI, Elizabeth Sui	911 11th St.	Anacortes	WA	98221	(360) 293-5393
HTWE, Khine M	3532 172nd St.	Arlington	WA	98223	(360) 653-4144
HTWE, Khine M	3532 172nd St.	Arlington	WA	98223	(360) 653-4144
HTWE, Khine M	3532 172nd St.	Arlington	WA	98223	(360) 653-4144
LIAN, Peng Za	801 Auburn Way North	Auburn	WA	98002	(253) 931-5550
ING, Seng	101 Auburn Way S	Auburn	WA	98002	(253) 804-0138
KO, Lwin Ko	253 High school Rd. NE	Bainbridge Island	WA	98110	(206) 842-7197
KHAI, Hau L.	401 NW 12th Ave.	Battleground	WA	98604	(360) 666-5108
VAN, Thang	2041 148th NE	Bellevue	WA	98007	(425) 865-8560
LABANG, Dee Sar	1645 140th NE	Bellevue	WA	98005	(425) 373-5263
LABANG, Dee Sar	1645 140th NE	Bellevue	WA	98005	(425) 373-5263
MOE, Khin Soe	300 Bellevue Way NE	Bellevue	WA	98004	(425) 455-6500
LIAN, Thein	1275 E. Sunset Drive	Bellingham	WA	98226	(360) 647-8311
MI, No	24040 Bothell Everette Hwy	Bothell	WA	98021	(425) 482-2767
MI, No	24040 Bothell Everette Hwy	Bothell	WA	98021	(425) 482-2767
CHUNG, Phun	5050 State Hwy 303 N.E.	Bremerton	WA	98311	(360) 792-2800
YOUN, Eun Kyeong	Building #990 Naval Base Kitsap	Bremerton	WA	98314	(360) 405-1971
LIVINGSTON, Po Sun	900 N Callow Ave	Bremerton	WA	98312	(360) 792-9149
Tun, Ye	1401 NE McWilliams Rd.	Bremerton	WA	98311	(360) 373-8911
Tun, Ye	1401 NE McWilliams Rd.	Bremerton	WA	98311	(360) 373-8911
MEN, Sui Za	14300 First Avenue South	Burien	WA	98168	(206) 433-6411
UK, James Hrang Tin	138 S.W. 148 St.	Burien	WA	98166	(206) 243-3043

Zenshi Food Service Counters

Franchise List

As of March 31, 2025

Franchisee Name	Address	City	State	Zip	Phone
ZINGHANG, Sam Nang	800 NE 3rd	Camas	WA	98607	(360) 834-7933
ZINGHANG, Sam Nang	800 NE 3rd	Camas	WA	98607	(360) 834-7933
Ying, Lut	400 Bridge St	Clarkston	WA	99403	(509) 758-5523
MAUNG, Kyaw Win	804 West 1st Street	Cle Elum	WA	98922	(509) 674-2580
MAUNG, Kyaw Win	804 West 1st Street	Cle Elum	WA	98922	(509) 674-2580
ZUNGTILIR, Silas	16735 SE 272nd St.	Covington	WA	98042	(253) 639-7408
THANG, Thla Tin	17023 SE 272nd St	Covington	WA	98042	(253) 630-0063
KHAING, Zin T	11 Grant Rd.	East Wenatchee	WA	98802	(509) 881-2808
KHAING, David Min	201 South Water	Ellensburg	WA	98926	(509) 962-0500
HUAI, Zam Tian	152 Roosevelt Ave E	Enumclaw	WA	98022	(360) 825-5023
LING , Tial Hmung	1150 Basin St SW	Ephrata	WA	98823	(509) 754-4441
LING , Tial Hmung	1150 Basin St SW	Ephrata	WA	98823	(509) 754-4441
LING , Tial Hmung	1150 Basin St SW	Ephrata	WA	98823	(509) 754-4441
LA, Mung Khawng	11031 19th Avenue SE	Everett	WA	98208	(425) 337-0886
LA, Mung Khawng	11031 19th Avenue SE	Everett	WA	98208	(425) 337-0886
HAU, Khup Khan	Bldg #2464, 105A W. Spaatz Rd	Fairchild AFB	WA	99011	(509) 244-5591
THANG, Rebekah Rinmawi	33702 21st Ave. SW	Federal Way	WA	98023	(253) 952-0108
THANG, Lal Ruat	1207 S 320th	Federal Way	WA	98003	(253) 839-8503
KIM, Grace	Fort Lewis Commissary BLDG 5275	Fort Lewis	WA	98433	(253) 966-8456
THA, Van Thawng	5502 Point Fosdic Dr. NW	Gig Harbor	WA	98335	(503) 797-5750
KIM, Hyon Tae	4831 Point Fosdick Drive NW	Gig Harbor	WA	98335	(253) 853-1950
JUN, Eun Kyung	11330 NW 51st	Gig Harbor	WA	98332	(253) 858-4750
HMUNG, Siang L	10105 224th St E	Graham	WA	98338	(253) 847-7050
HMUNG, Siang L	10105 224th St E	Graham	WA	98338	(253) 847-7050
KHAI, Lian Thawn	408 NE 81st St	Hazel Dell	WA	98665	(360) 574-1141
NUN, Ngur	6100 E. Lake Sammamish Parkway SE	Issaquah	WA	98029	(425) 416-1100
ZAU, Thang	735 Gilman Blvd	Issaquah	WA	98027	(425) 392-0410
ZUAL, Dong	1451 Highlands Drive NE	Issaquah	WA	98029	(425) 369-3113
AUNG, Moe Kyaw	2811 W. 10th Ave.	Kennewick	WA	99336	(509) 735-8700
BAWI, Thla	10201 SE 240th	Kent	WA	98031	(253) 859-5500
PAR, Van Nei	25250 Pacific Hwy S.	Kent	WA	98032	(253) 946-7403
TIAL, Fam Men	20830 108th Ave SE	Kent	WA	98031	(253) 854-2814
UK, Francis Cung Biak	210 Washington Ave S	Kent	WA	98032	(253) 852-4454
THIN, Thin	13101 SE Kent Kangley Rd	Kent	WA	98030	(253) 638-7275
THANG, Lian	12221 120th Avenue NE	Kirkland	WA	98034	(425) 820-3203
THIN, Atae	14444 124th Ave N.E.	Kirkland	WA	98034	(425) 821-2112
THIN, Atae	14444 124th Ave N.E.	Kirkland	WA	98034	(425) 821-2112
BAWI, Heman	700 Sleater-Kenniey Rd. S.E.	Lacey	WA	98503	(360) 438-6462
HRILA, Lal Nun	4700 Yelm Hwy SE	Lacey	WA	98503	(360) 438-0203
DIM, Ngun Lian	1243 Marvin Rd NE	Lacey	WA	98516	(360) 438-3914
HTWE, Htet Nandar	717 State Route 9 NE	Lake Stevens	WA	98258	(425) 249-4000
SUNG, Nei	10223 Gravelly Lake Drive	Lakewood	WA	98499	(253) 581-2072
MANG, Za Lun	1304 N Liberty Lake Rd	Liberty Lake	WA	99019	(509) 924-2374
KYAW, Hnin Yi	3184 Ocean Beach Highway	Longview	WA	98632	(360) 636-1010
WEDEKIND, MAO	8071 Guide Meridian Rd 101	Lynden	WA	98264	(360) 318-0688
LUNG, Seng	12811 Beverly Park Rd	Lynnwood	WA	98087	(425) 347-3060
OO, Aung Zaw	26520 Maple Valley Black	Maple Valley	WA	98038	(360) 636-1010
OO, Aung Zaw	26520 Maple Valley Black	Maple Valley	WA	98038	(360) 636-1010
OO, Aung Zaw	26520 Maple Valley Black	Maple Valley	WA	98038	(360) 636-1010
NUAM, Mang	26916 Maple Valley Black Diamond Rd	Maple Valley	WA	98038	(425) 432-2020
NUAM, Mang	26916 Maple Valley Black Diamond Rd	Maple Valley	WA	98038	(425) 432-2020
SAVIO, Khun	13900 45th Ave. NE	Marysville	WA	98271	(425) 304-3411
SAVIO, Khun	13900 45th Ave. NE	Marysville	WA	98271	(425) 304-3411
SHEIN, Kyi Tha	577 Lincoln Bl.	McChord AFB	WA	98438	(253) 982-3285
CUNG, Tuan Ceu	900 Meridian Ave E	Milton	WA	98354	(253) 927-2332
LIAN, Ral Bawi	4301 212th St SW	Mountlake Terrace	WA	98043	(425) 775-4154
OO, Bo Thawn	2604 Ohio Street	NBK-BANGOR	WA	98315	(360) 396-6025
THANG, Par Tin Dim	6911 Coal Creek Pkwy SE	Newcastle	WA	98059	(425) 641-0902
CIN, Khan	2090 N Coral Sea Ave.	Oak Harbor	WA	98278	(360) 257-3318
THEINKANG, Zamishar	1450 SW Erie Street	Oak Harbor	WA	98277	(360) 279-8828
MIN, Kyaw Sein	4280 Martin Way E	Olympia	WA	98516	(360) 456-7132
MENG, Britney Par Ci	3215 Harrison Ave. NW	Olympia	WA	98502	(360) 956-3782
MIN, Kyaw Sein	4280 Martin Way E	Olympia	WA	98516	(360) 456-7132
SOE, Myo Hein	1330 N. 20th Ave	Pasco	WA	99301	(509) 547-8858
SANG, Ram Hnin	110 East 3rd Street	Port Angeles	WA	98362	(360) 457-0788
YANG, Jung Woo	1900 SE Sedgwick Rd.	Port Orchard	WA	98366	(360) 874-7148
MAUNG, Ko Ko	370 SW Sedgwick Road	Port Orchard	WA	98367	(360) 874-8300
MAUNG, Ko Ko	370 SW Sedgwick Road	Port Orchard	WA	98367	(360) 874-8300
KI, Ngun Tha	442 W. Sims Way	Port Townsends	WA	98368	(360) 385-2806
WATANABE, Iori	19245 10th Ave N.E	Poulsbo	WA	98370	(360) 394-0023
NAING, Zaw Lin	430 S. E. Bishop Blvd	Pullman	WA	99163	(509) 334-0803

Zenshi Food Service Counters

Franchise List

As of March 31, 2025

Franchisee Name	Address	City	State	Zip	Phone
CUNG, No Uk	1100 N. Meridian East	Puyallup	WA	98371	(253) 840-8150
CUNG, No Uk	1100 N. Meridian East	Puyallup	WA	98371	(253) 840-8150
THANG, Thia	13308 Meridian East	Puyallup	WA	98373	(253) 864-7277
YI, Aekyung Annie	5608 176th St E	Puyallup	WA	98375	(253) 414-1737
VAN, Thao T	17667 NE 76th Street	Redmond	WA	98052	(425) 556-8000
MOHAMAD ALI, Mohamad Elias Bin	17246 Redmond Way N.E.	Redmond	WA	98052	(425) 885-3323
MOHAMAD ALI, Mohamad Elias Bin	17246 Redmond Way N.E.	Redmond	WA	98052	(425) 885-3323
MOHAMAD ALI, Mohamad Elias Bin	17246 Redmond Way N.E.	Redmond	WA	98052	(425) 885-3323
SOLOMON, Suan	17801 108th Ave SE	Renton	WA	98055	(425) 235-5365
MARY, Rose	365 Renton Center Way SW	Renton	WA	98055	(425) 204-5200
SUNGCCA BAWI, Ling Bawi	17230 140th SE	Renton	WA	98058	(425) 228-1740
THANG, Ngun Thawng	200 S. 3rd St.	Renton	WA	98057	(425) 255-4151
NYO, Mu	690 Gage Blvd	Richland	WA	99352	(509) 627-5133
MARAN, Pius Tumai	1803 George Washington Way	Richland	WA	99354	(509) 946-9605
NYO, Mu	690 Gage Blvd	Richland	WA	99352	(509) 627-5133
SOE, Hein Latt	101 Wellsian Way	Richland	WA	99352	(509) 946-2808
SIAN, John Kham	4754 42nd Ave. SW	Seattle	WA	98116	(206) 932-6026
LEE, Ngan Mee	3820 Rainier Ave S	Seattle	WA	98118	(206) 725-9575
PEIK, Kyaw	1410 E. John St.	Seattle	WA	98112	(206) 323-4988
HNIN, Za Cung	12318 15th Ave NE	Seattle	WA	98125	(206) 306-0504
SIAN, John Kham	4754 42nd Ave. SW	Seattle	WA	98116	(206) 932-6026
NYO, Htay	2201 E. Madison St.	Seattle	WA	98112	(206) 494-1518
SUAN, Mang Hau	2622 California Ave SW	Seattle	WA	98116	(206) 937-2272
PEIK, Kyaw	1410 E. John St.	Seattle	WA	98112	(206) 323-4988
HNUNA, Lian	680F West Washington	Sequim	WA	98382	(360) 681-2905
THANG, Pau Lal	301 East Wallace-Kneeland Blvd	Shelton	WA	98584	(360) 427-2979
KHINE, Zaw Myo	3010 E. 57th Ave	Spokane	WA	99223	(509) 443-6403
KHUAL, Dong Cin	12120 N. Division St.	Spokane	WA	99218	(509) 465-4400
THANG, Lian Go	400 South Thor St.	Spokane	WA	99202	(509) 532-4000
TUANG, Ning Khan	9001 N Indian Trail Rd	Spokane	WA	99208	(509) 465-8110
TUANG, Vum Lam	13606 East 32nd Ave	Spokane	WA	99206	(509) 892-2112
KHUAL, Peter Lian Khan	3919 N. Market Street	Spokane	WA	99207	(509) 484-5195
NAING, Kee	8851 E Trent Ave	Spokane Valley	WA	99212	(509) 924-9014
DRAGON BALL SUSHI LLC.	15609 E. Sprague Rd.	Spokane Valley	WA	99037	(509) 921-5350
CIN, Biak	1201 Valley Avenue	Sumner	WA	98390	(253) 826-8414
CIN, Biak	1201 Valley Avenue	Sumner	WA	98390	(253) 826-8414
CIN, Biak	1201 Valley Avenue	Sumner	WA	98390	(253) 826-8414
CIN, Biak	1201 Valley Avenue	Sumner	WA	98390	(253) 826-8414
DALANGGING, Mung Hkrap	3842 Bridgeport Way	Tacoma	WA	98466	(253) 565-6215
AUNG, Thawng	1624 E 72nd St	Tacoma	WA	98404	(253) 537-2124
MAWI, Cer	1302 South 38th St	Tacoma	WA	98418	(253) 471-1630
HNIN, Bawi	2637 North Pearl St.	Tacoma	WA	98407	(253) 759-9251
AUNG, Thawng	1624 E 72nd St	Tacoma	WA	98404	(253) 537-2124
MEN, Ngun	2411 North Proctor St.	Tacoma	WA	98406	(253) 752-5570
MANG, Lal Cung	555 Trosper Road SW	Tumwater	WA	98512	(360) 753-7900
AN, Jin Man	520 Cleveland Ave. SE	Tumwater	WA	98501	(360) 943-1830
KIM, Sung Heon	6305 Bridgeport Way West	University Place	WA	98467	(253) 460-4000
CHEN, Jinxia	16600 SE McGillivray Blvd.	Vancouver	WA	98683	(360) 260-3308
NUAM, Lam Ngath	7411 NE 117th Ave.	Vancouver	WA	98662	(360) 896-3500
CING, Niang Lam	800 NE Tenney Rd.,	Vancouver	WA	98686	(360) 571-2540
CIN, Pau Khaw	2500 Columbia House Blvd	Vancouver	WA	98661	(360) 992-3500
MAN LAL, Zen Lam	6711 NE 63rd St.	Vancouver	WA	98661	(360) 992-5680
PIANG, Nang Sian	13023 NE Hwy 99	Vancouver	WA	98686	(360) 566-7980
KIM, Morgan	19150 NE Woodinville Duvall Rd	Woodinville	WA	98077	(425) 788-9150
MAUNG, Aung Lwin	1725 Pacific Ave.	Woodland	WA	98674	(360) 225-4370
LIU, Bixiang	1206 North 40th Ave	Yakima	WA	98908	(509) 576-6808
THANG, Thawng Zam	1109 Yelm Ave E	Yelm	WA	98597	(360) 458-8830
LEE, Xiong	703 University Ave	Madison	WI	53715	(608) 287-0000
MAUNG, Sithukyaw	6360 US Route 60	Barboursville	WV	25504	(304) 733-3370
OHN, Soe Than	151 N Beaver Ln	Beaver	WV	25813	(304) 255-5525
OHN, Soe Than	151 N Beaver Ln	Beaver	WV	25813	(304) 255-5525
SAN, Tin Win	80 Skyline Drive Plaza	Buckhannon	WV	26201	(304) 472-0918
SAN, Tin Win	80 Skyline Drive Plaza	Buckhannon	WV	26201	(304) 472-0918
AUNG, Pwint Zar	981 Dunbar village	Dunbar	WV	25064	(304) 768-6481
AUNG, Pwint Zar	981 Dunbar village	Dunbar	WV	25064	(304) 768-6481
AUNG, Pwint Zar	981 Dunbar village	Dunbar	WV	25064	(304) 768-6481
AUNG, Pwint Zar	981 Dunbar village	Dunbar	WV	25064	(304) 768-6481
RAKHA, John	19 7th Ave W	Huntington	WV	25701	(304) 522-1201
RAKHA, John	19 7th Ave W	Huntington	WV	25701	(304) 522-1201
KHAING, Aung Myat	10635 MacCorkle Ave	Marmet	WV	25315	(304) 949-6124
KHAING, Aung Myat	10635 MacCorkle Ave	Marmet	WV	25315	(304) 949-6124

Zenshi Food Service Counters
Franchise List
As of March 31, 2025

Franchisee Name	Address	City	State	Zip	Phone
KHAING, Aung Myat	10635 MacCorkle Ave	Marmet	WV	25315	(304) 949-6124
SOE, Linda	350 Patteson Dr.	Morgantown	WV	26505	(304) 599-5324
SOE, Linda	350 Patteson Dr.	Morgantown	WV	26505	(304) 599-5324
AYE LWIN, Antony	411 Mall Rd	Oak Hill	WV	25901	(304) 469-2921
AYE LWIN, Antony	411 Mall Rd	Oak Hill	WV	25901	(304) 469-2921
MUN, Khaing	1229 Stafford Dr	Princeton	WV	24740	(304) 487-6136
SOE, May N	178 Red Oaks Shopping Center	Ronceverte	WV	24970	(304) 645-7411
KHEE, Sai Lao	1439 Maccorkle Ave	Saint Albans	WV	25177	(304) 722-4248
KHEE, Sai Lao	1439 Maccorkle Ave	Saint Albans	WV	25177	(304) 722-4248
KHEE, Sai Lao	1439 Maccorkle Ave	Saint Albans	WV	25177	(304) 722-4248
MIN, Maung Naing	1076 Cy Ave	Casper	WY	82604	(307) 206-0136
LUNN, Nyo Chit	2625 East 2nd St.	Casper	WY	82609	(307) 237-9361
THIRINDA, FNU	3355 East Pershing Blvd	Cheyenne	WY	82001	(307) 635-1151
THIRINDA, FNU	3355 East Pershing Blvd	Cheyenne	WY	82001	(307) 635-1151
KAM, Ebenezer	1825 17th Street	Cody	WY	82414	(307) 527-7007
HLA, Maung	6205 Missile Dr.	F.E Warren AFB	WY	82005	(307) 773-3509
WIN, Naing Naing	2610 South Douglas Hwy	Gillette	WY	82718	(307) 686-7352
MYI, Aung	105 Buffalo Way	Jackson	WY	83001	(307) 733-5950
ZING, Biak Hnem	1165 Main Street	Lander	WY	82520	(307) 332-3636
MUN, Heeil	3112 East Grand Ave	Laramine	WY	82070	(307) 742-8146
MUN, Heeil	3112 East Grand Ave	Laramine	WY	82070	(307) 742-8146
GYI, Maung Than Lun	1865 Coffeen Ave	Sheridan	WY	82801	(307) 672-8909

If you buy this franchise, your contact information may be disclosed to other buyers when you leave the franchise system.

Zenshi Food Service Counters
Company Owned Locations
As of March 31, 2025

Store Code	Operator Name	Address	City	State	Zip	Phone	Store Code
CAR3410	AFCFC	30 College Rd.	Fairbanks	AK	99701	(907) 374-4100	CAR3410
KRO0854V	AFCFC	1101 Bellline Road S.W	Decatur	AL	35601	(256) 350-9770	KRO0854V
PUB0598	AFCFC	8000 Madison Blvd	Madison	AL	35758	(256) 461-1860	PUB0598
PUB1642	AFCFC	7129 Wall Triana Hwy	Madison	AL	35757	(256) 722-3786	PUB1642
PUB1692	AFCFC	3201 Endeavor Ln	Vestavia Hills	AL	35242	(205) 967-5998	PUB1692
SAF0248	AFCFC	1751 Highway 095	Bullhead City	AZ	86442	(928) 763-3555	SAF0248
SAF1543	AFCFC	29834 North Cave Creek Road	Cave Creek	AZ	85331	(480) 563-9335	SAF1543
SAF1771	AFCFC	1305 W. Duval Mine Road	Green Valley	AZ	85614	(520) 648-2847	SAF1771
SAF1055	AFCFC	7720 E. Highway 69	Prescott	AZ	86314	(928) 772-6126	SAF1055
SAF1491	AFCFC	7920 E. Chaparral Rd.	Scottsdale	AZ	85250	(480) 532-8588	SAF1491
SAF1207	AFCFC	2300 West Highway 89A	Sedona	AZ	86336	(928) 282-0118	SAF1207
RLF0083	AFCFC	13321 South St.	Cerritos	CA	90701	(562) 860-5635	RLF0083
RLF0168	AFCFC	125 N. El Camino Real	Encinitas	CA	92024	(760) 942-5472	RLF0168
MIL0031	AFCFC	3920 Inner Loop Rd., Bldg. 920	Fort Irwin	CA	92310	(760) 380-3560	MIL0031
RLF0055	AFCFC	521 W. Foothill Blvd.	La Canada	CA	91011	(818) 790-0584	RLF0055
VO-3263	AFCFC	1342 North Alvarado	Los Angeles	CA	90026	(213) 483-5573	VO-3263
RLF0008	AFCFC	1435 W. Chapman Ave	Orange	CA	92868	(714) 634-2905	RLF0008
NGM017	AFCFC	16259 Paramount Blvd.	Paramount	CA	90723	(562) 259-9950	NGM017
SAF2695	AFCFC	1770 Pleasant Grove Blvd	Roseville	CA	95747	(916) 677-0000	SAF2695
SAF2242W	AFCFC	1025 Alhambra Blvd	Sacramento	CA	95816	(916) 456-0852	SAF2242W
RLF0015	AFCFC	638 Camino del los Mares	San Clemente	CA	92673	(949) 496-8616	RLF0015
RLF0087	AFCFC	1050 N. Western Ave.	San Pedro	CA	90732	(310) 833-3506	RLF0087
NGM007B	AFCFC	2603 Westminster Ave.	Santa Ana	CA	92706	(714) 515-5056	NGM007B
SAF0911	AFCFC	477 West Napa	Sonoma	CA	95476	(707) 996-0633	SAF0911
SAF2605	AFCFC	1026 Hunt Ave.	St. Helena	CA	94574	(707) 968-3620	SAF2605
ALB0840	AFCFC	8750 North Union Blvd	Colorado Springs	CO	80920	(719) 282-9066	ALB0840
SAF2913	AFCFC	2160 W. Drake Road	Fort Collins	CO	80521	(970) 484-6048	SAF2913
SAF0836	AFCFC	1008 Summit Blvd	Frisco	CO	80443	(970) 668-5144	SAF0836
SAF1552	AFCFC	1426 E. Harmony Road	Ft. Collins	CO	80525	(970) 223-6335	SAF1552
MIL0098	AFCFC	5126 Community Center Dr.	USAF Academy	CO	80840	(719) 333-2025	MIL0098
SAF0631	AFCFC	2131 North Frontage Road	West Vail	CO	81657	(970) 476-3561	SAF0631
HT-336	AFCFC	26370 Bay Farm Rd	Millsboro	DE	19966	(302) 945-1705	HT-336
PUB1325	AFCFC	26841 Tamiami Trail	Bonita Springs	FL	34134	(239) 992-0105	PUB1325
PUB1114	AFCFC	11600 W. Sample Rd.	Coral Springs	FL	33065-2646	(954) 509-5288	PUB1114
PUB0697	AFCFC	8725 Placida Rd	Placida	FL	33946	(941) 698-1699	PUB0697
PUB0734	AFCFC	1445 E Venice Ave	Venice	FL	34292	(941) 480-0779	PUB0734
KRO0363A	AFCFC	48 Bullsboro Dr.	Newnan	GA	30263	(770) 251-4791	KRO0363A
PUB1256	AFCFC	7936 GA Highway 21	Port Wentworth	GA	31407	(912) 966-5895	PUB1256
SAF1470	AFCFC	121 W Neider Ave	Coeur d'Alene	ID	83815	(208) 765-4311	SAF1470
SAF0254	AFCFC	161 W Prairie Shopping Ctr	Hayden	ID	83835	(208) 772-0847	SAF0254
SAF0350	AFCFC	702 N. 5th Ave.	Sandpoint	ID	83864	(208) 263-9638	SAF0350
JEW2488	AFCFC	655 Main St. NW	Bourbonnais	IL	60914	(815) 929-0560	JEW2488
JEW0901	AFCFC	3400 N Western	Chicago	IL	60618	(773) 327-1204	JEW0901
JEW1282	AFCFC	4729 N Central Ave	Chicago	IL	60630	(773) 777-1142	JEW1282
JEW3344	AFCFC	1220 S Ashland Ave	Chicago	IL	60608	(312) 733-0153	JEW3344
JEW3376	AFCFC	370 North Desplaines Ave	Chicago	IL	60661	(312) 775-0991	JEW3376
JEW3454	AFCFC	4250 N. Lincoln Ave	Chicago	IL	60618	(773) 472-6171	JEW3454
TFF1667	AFCFC	5630 W Belmont	Chicago	IL	60634	(773) 993-0090	TFF1667
TFF567	AFCFC	3607 West Fullerton	Chicago	IL	60647	(773) 278-8355	TFF567
KRO0705T	AFCFC	201 S Main St.	East Peoria	IL	61611	(309) 694-6298	KRO0705T
SCH229	AFCFC	2222 Troy Rd	Edwardsville	IL	62025	(314) 436-5568	SCH229
JEW3428	AFCFC	1128 Chicago Ave	Evanston	IL	60202	(847) 869-7950	JEW3428
JEW0052	AFCFC	21164 S. LaGrange Rd.	Frankfort	IL	60423	(815) 464-5352	JEW0052
JEW3776	AFCFC	2021 E Laraway Rd.	New Lenox	IL	60451	(815) 463-4958	JEW3776
TFF167	AFCFC	8900 N. Greenwood Ave	Niles	IL	60714	(847) 795-4600	TFF167
JEW0086	AFCFC	8801 S Ridgeland	Oak Lawn	IL	60453	(708) 599-4500	JEW0086
JEW3051	AFCFC	9350 W 159th St.	Orland Park	IL	60462	(708) 403-6920	JEW3051
JEW3192	AFCFC	17930 Wolf Rd.	Orland Park	IL	60467	(708) 479-1573	JEW3192
JEW3053	AFCFC	12803 S. Harlem Ave	Palos Heights	IL	60463	(708) 671-1568	JEW3053
JEW2160	AFCFC	9652 W 131st Street	Palos Park	IL	60462	(708) 361-8880	JEW2160

Zenshi Food Service Counters
Company Owned Locations
As of March 31, 2025

Store Code	Operator Name	Address	City	State	Zip	Phone	Store Code
KRO0917T	AFCFC	801 W Lake Ave	Peoria	IL	61614	(309) 682-2173	KRO0917T
TFF1267	AFCFC	2300 Illinois 59	Plainfield	IL	60586	(815) 733-2135	TFF1267
JEW3223	AFCFC	7525 W. Lake St.	River Forest	IL	60305	(708) 771-0044	JEW3223
JEW3432	AFCFC	900 E Rollins Rd.	Round Lake	IL	60073	(847) 223-9201	JEW3432
TFF1967	AFCFC	965 E. Rollins Rd	Round Lake Beach	IL	60073	(224) 365-8888	TFF1967
KRO0888T	AFCFC	201 E Bidwell St.	Taylorville	IL	62568	(317) 579-8100	KRO0888T
JEW3165	AFCFC	17117 Harlem Ave.	Tinley Park	IL	60477	(708) 532-7414	JEW3165
TFF2167	AFCFC	1700 North Lewis Ave	Waukegan	IL	60085	(847) 999-0650	TFF2167
JEW1306	AFCFC	1250 W. Main St.	West Dundee	IL	60118	(847) 428-3355	JEW1306
JEW3503	AFCFC	145 South Eastwood Dr.	Woodstock	IL	60098	(815) 206-0499	JEW3503
STV003	AFCFC	1605 Calumet Ave.	Valparaiso	IN	46383	(219) 464-8606	STV003
KRO0913L	AFCFC	1300 Anderson Crossing Dr	Lawrenceburg	KY	40342	(502) 859-0234	KRO0913L
KRO0224L	AFCFC	2200 Brownsboro Road	Louisville	KY	40206	(502) 897-1133	KRO0224L
SHA1419	AFCFC	301 Pond Street	Ashland	MA	1721	(508) 881-5125	SHA1419
SHA0603	AFCFC	137 Teaticket Hwy	East Falmouth	MA	2536	(508) 548-4033	SHA0603
SHA3581	AFCFC	255 East Central Street	Franklin	MA	2038	(508) 520-6880	SHA3581
SHA2594	AFCFC	1 Snow Road	Marshfield	MA	2050	(781) 837-5100	SHA2594
SHA1414	AFCFC	230 Main St	Medfield	MA	2052	(508) 359-8713	SHA1414
SHA2491	AFCFC	45 Storey Ave.	Newburyport	MA	1950	(978) 462-7121	SHA2491
SHA2585	AFCFC	2260 State Road	Plymouth	MA	2360	(508) 883-2975	SHA2585
SHA3577	AFCFC	75 Spring street	West Roxbury	MA	2132	(617) 327-0564	SHA3577
SHA3413	AFCFC	610 Middle St	Weymouth	MA	2817	(781) 331-5108	SHA3413
MIL0118	AFCFC	694 Kinkaid Road	Annapolis	MD	21402	(240) 498-7666	MIL0118
HT-324	AFCFC	15501 Annapolis Rd, Ste 400	Bowie	MD	20715	(301) 383-2935	HT-324
HT-325	AFCFC	14101 Darnestown Rd.	Germantown	MD	20874	(240) 631-1310	HT-325
HT-403	AFCFC	18169 Towncenter Dr.	Olney	MD	20832	(301) 260-1792	HT-403
SHA4556	AFCFC	353 Main Street.	Bangor	ME	4401	(207) 942-9441	SHA4556
SHA0553	AFCFC	1 Chandler Dr.	Bath	ME	4530	(207) 443-9179	SHA0553
SHA0628	AFCFC	147 Bath Rd. Route 1	Brunswick	ME	4011	(207) 721-9996	SHA0628
SHA4651	AFCFC	251 US Highway 1	Falmouth	ME	4105	(207) 781-6581	SHA4651
SHA2626	AFCFC	4 SCAMMON STREET	SACO	ME	4072	(207) 284-9666	SHA2626
SCH191	AFCFC	11253 St. charles Rock Rd	Bridgeton	MO	63044	(314) 738-0677	SCH191
SCH212	AFCFC	45 Gravois Bluffs Plaza Dr.	Fenton	MO	63026	(626) 343-1216	SCH212
GRE118	AFCFC	2101 Schotthill Woods Dr	Jefferson City	MO	65101	(573) 659-3600	GRE118
GRE122	AFCFC	2805 W Truman Blvd	Jefferson City	MO	65109	(573) 893-3111	GRE122
SCH143	AFCFC	3430 S. Grand Blvd.	St. Louis	MO	63118	(314) 772-5500	SCH143
SAF1581	AFCFC	570 North Montana Street	Dillon	MT	59725	(406) 683-5002	SAF1581
SAF1486	AFCFC	611 N Montana Street	Helena	MT	59601	(406) 443-1598	SAF1486
ALB0019	AFCFC	117 W. Janeaux St.	Lewistown	MT	59457	(406) 538-5454	ALB0019
HT-172	AFCFC	1817 Martin Luther King Jr. Pkwy.	Durham	NC	27707	(919) 489-9887	HT-172
PUB1470	AFCFC	6828 Matthews Mint Hill Road	Mint Hill	NC	28227	(704) 573-0234	PUB1470
HT-026	AFCFC	7400 Creedmoor Rd.	Raleigh	NC	27613	(919) 848-1464	HT-026
HT-495	AFCFC	8345 Creedmoor Rd	Raleigh	NC	27613	(919) 659-8221	HT-495
SHA4486	AFCFC	1328 Hooksett Rd	Hooksett	NH	3106	(603) 623-8846	SHA4486
SHA2492	AFCFC	586 Nashua Street	Milford	NH	3055	(603) 672-3336	SHA2492
SHA0621	AFCFC	100 Shaws Lane	Stratham	NH	3885	(603) 778-8545	SHA0621
TOP0041	AFCFC	3980 Maple Road	Amherst	NY	14226	(716) 515-0075	TOP0041
TOP0224	AFCFC	2351 MAPLE ROAD	AMHERST	NY	14221	(716) 515-3200	TOP0224
TOP0368	AFCFC	8417 OSWEGO ROAD	BALDWINSVILLE	NY	13027	(315) 652-4934	TOP0368
TOP0232	AFCFC	2101 ELMWOOD AVENUE	BUFFALO	NY	14207	(716) 515-0050	TOP0232
TOP0535	AFCFC	1936 US-6	Carmel Hamlet	NY	10512	(845) 225-4151	TOP0535
TOP0367	AFCFC	71 NELSON STREET	CAZENOVIA	NY	13035	(315) 655-4565	TOP0367
TOP0202	AFCFC	3865 UNION ROAD	CHEEKTOWAGA	NY	14225	(716) 684-5927	TOP0202
TOP0214	AFCFC	5175 Broadway	Depew	NY	14043	(716) 515-3440	TOP0214
TOP0220	AFCFC	4777 TRANSIT ROAD	DEPEW	NY	14043	(716) 515-3280	TOP0220
TOP0237	AFCFC	6363 Transit Rd	Depew	NY	14043	(716) 601-0180	TOP0237
TOP0264	AFCFC	3955 VINEYARD DRIVE	Dunkirk	NY	14048	(716) 366-2050	TOP0264
TOP0363	AFCFC	350 Towne Dr.	Fayetteville	NY	13066	(315) 637-8039	TOP0363
TOP0418	AFCFC	3507 MT. READ BLVD	Greece	NY	14616	(585) 663-4400	TOP0418
TOP0365	AFCFC	119 WEST SENECA STREET	MANLIUS	NY	13104	(315) 682-7261	TOP0365

Zenshi Food Service Counters
Company Owned Locations
As of March 31, 2025

Store Code	Operator Name	Address	City	State	Zip	Phone	Store Code
TOP0240	AFCFC	301 Meadow Dr	North Tonawanda	NY	14120	(716) 743-4350	TOP0240
TOP0417	AFCFC	1601 PENFIELD ROAD	Rochester	NY	14625	(585) 264-0820	TOP0417
TOP0362	AFCFC	620 NOTTINGHAM ROAD	SYRACUSE	NY	13224-2234	(315) 446-1652	TOP0362
TOP0049	AFCFC	355 ORCHARD PARK RD.	West Seneca	NY	14224	(716) 517-3000	TOP0049
SAF1659	AFCFC	1990 14th Ave. SE	Albany	OR	97322	(541) 812-2380	SAF1659
SAF3557	AFCFC	6055 SW 185th Ave	Aloha	OR	97078	(503) 642-7059	SAF3557
SAF2631	AFCFC	14555 SW Teal Blvd.	Beaverton	OR	97007	(503) 590-9755	SAF2631
ALB2599	AFCFC	1800 NE 3rd Street	Bend	OR	97701	(541) 382-3661	ALB2599
ALB3553	AFCFC	61155 S Hwy 97	Bend	OR	97702	(541) 382-3600	ALB3553
SAF0514	AFCFC	642 East 3rd St	Bend	OR	97701	(541) 312-6480	SAF0514
SAF4404	AFCFC	138 W. Ellendale	Dallas	OR	97338	(503) 831-6000	SAF4404
FM-417	AFCFC	3333 W 11th Ave.	Eugene	OR	97402	(541) 484-4200	FM-417
SAF0572	AFCFC	311 Coburg Road	Eugene	OR	97401	(541) 342-7635	SAF0572
FM-464	AFCFC	4701 Highway 101	Florence	OR	97439	(541) 902-7300	FM-464
SAF0406	AFCFC	2836 Pacific Ave	Forest Grove	OR	97116	(503) 359-8700	SAF0406
SAF0415	AFCFC	4101 Logan Road	Lincoln City	OR	97367	(541) 994-8667	SAF0415
SAF1601	AFCFC	2490 N. Hwy 99	McMinnville	OR	97128	(503) 435-3120	SAF1601
SAF1557	AFCFC	1735 Virginia Ave	North Bend	OR	97459	(541) 751-7000	SAF1557
SAF1665	AFCFC	1705 South Highway 97	Redmond	OR	97756	(541) 504-4160	SAF1665
FM-516	AFCFC	30300 SW Boones Ferry Road	Wilsonville	OR	97070	(503) 570-3509	FM-516
AMZ043	AFCFC	1837 Street Road	Bensalem	PA	19020	(888) 280-4331	AMZ043
MIL0010	AFCFC	851 Summer Road	Carlisle Barracks	PA	17013	(717) 245-3105	MIL0010
GRV0001	AFCFC	49 Pine Grove Square	Grove City	PA	16127	(724) 458-7544	GRV0001
SHA0625	AFCFC	8 Chapel View Blvd	Cranston	RI	2920	(401) 464-8388	SHA0625
KRO0020A	AFCFC	781 Main St.	North Myrtle Beach	SC	29582	(843) 249-9950	KRO0020A
MIL0081	AFCFC	BUILDING 407 WAKE BOULEVARD	Parris Island	SC	29905	(843) 228-2383	MIL0081
PUB1866	AFCFC	1274 NEXTON PKWY	Summerville	SC	29486	(863) 688-1188	PUB1866
MIL0019	AFCFC	2649 LeMay Blvd.	Ellsworth AFB	SD	57706	(605) 385-5056	MIL0019
PUB1166	AFCFC	5928 Hixson Pike Ste 112	Hixson	TN	37343	(423) 847-8461	PUB1166
MIL0071	AFCFC	5722 Integrity Dr.	Millington	TN	38054	(901) 874-5125	MIL0071
LOE161	AFCFC	7708 Lohmann Ford Road	Lago Vista	TX	78645	(512) 267-0355	LOE161
HT-051	AFCFC	237 Hanbury Rd. E.	Chesapeake	VA	23322	(757) 546-9074	HT-051
PUB2030	AFCFC	2200 GENERAL BOOTH BLVD	VIRGINIA BEACH	VA	23454	(800) 242-1227	PUB2030
SAF1571	AFCFC	23961 NE STATE ROUTE 3	Belfair	WA	98528	(360) 275-0922	SAF1571
SAF0544	AFCFC	21301 Hwy 410	Bonneylake	WA	98380	(253) 862-1212	SAF0544
SAF0535	AFCFC	20711 Bothell Everett Hwy	Bothell	WA	98012	(425) 483-1060	SAF0535
SAF1186	AFCFC	27035 Pacific Hwy S	Des Moines	WA	98198	(253) 946-8087	SAF1186
SAF3540	AFCFC	21401 Pacific Hwy S	Des Moines	WA	98198	(206) 824-2737	SAF3540
SAF1572	AFCFC	14020 Main St. N.E.	DUVALL	WA	98019	(425) 844-1188	SAF1572
SAF3521	AFCFC	510 Grant Rd	East Wenatchee	WA	98802	(509) 884-0707	SAF3521
SAF1297	AFCFC	23632 Hwy 99	Edmonds	WA	98026	(425) 778-1411	SAF1297
SAF3501	AFCFC	2109 S.W. 336th St	Federal Way	WA	98023	(253) 838-9941	SAF3501
SAF0186	AFCFC	8196 NE Hwy 104	Kingston	WA	98346	(360) 297-1800	SAF0186
ALB0471	AFCFC	301 Marysville Mall	Marysville	WA	98270	(360) 659-5841	ALB0471
SAF1413	AFCFC	3322 132nd St. SE	Mill Creek	WA	98012	(425) 338-0775	SAF1413
SAF1528	AFCFC	460 SW Mt Si Blvd	North Bend	WA	98045	(425) 831-2122	SAF1528
SAF3319	AFCFC	4300 NE 4th Street	Renton	WA	98059	(425) 226-7666	SAF3319
SAF0423	AFCFC	7340 35th N.E.	Seattle	WA	98115	(206) 524-7064	SAF0423
SAF1143	AFCFC	8340 15th Ave N.W.	Seattle	WA	98117	(206) 782-7464	SAF1143
SAF1477	AFCFC	1423 NW Market St.	Seattle	WA	98107	(206) 784-6480	SAF1477
SAF1493	AFCFC	4011 S 164th	Seattle	WA	98188	(206) 244-2567	SAF1493
SAF1550	AFCFC	7300 Roosevelt Way NE	Seattle	WA	98115	(206) 525-6348	SAF1550
SAF1885	AFCFC	516 1st. Ave. W.	Seattle	WA	98119	(206) 494-1685	SAF1885
SAF1965	AFCFC	9262 Rainier Ave. So.	Seattle	WA	98118	(206) 494-1120	SAF1965
SAF0585	AFCFC	600 Franklin St	Shelton	WA	98584	(360) 426-9978	SAF0585
SAF0497	AFCFC	17202 15TH AVE NE	Shoreline	WA	98155	(206) 363-3130	SAF0497
ALB3419	AFCFC	17520 SR 9 SE	Snohomish	WA	98296	(360) 668-1132	ALB3419
ALB0265	AFCFC	6520 North Nevada St	Spokane	WA	99208	(509) 489-1250	ALB0265
SAF1242	AFCFC	2509 E. 29th Ave	Spokane	WA	99223	(505) 532-0822	SAF1242
SAF1299	AFCFC	10100 N Newport Hwy	Spokane	WA	99218	(509) 465-2576	SAF1299

Zenshi Food Service Counters
 Company Owned Locations
 As of March 31, 2025

Store Code	Operator Name	Address	City	State	Zip	Phone	Store Code
SAF1473	AFCFC	14020 E Sprague Ave	Spokane	WA	99216	(509) 921-9859	SAF1473
SAF1494	AFCFC	2507 W Wellesley	Spokane	WA	99205	(509) 327-4593	SAF1494
SAF3248	AFCFC	902 W Francis Ave	Spokane	WA	99205	(509) 327-4880	SAF3248
SAF3255	AFCFC	933 Mission Ave	Spokane	WA	99202	(509) 482-1987	SAF3255
ALB0493	AFCFC	104 Military Rd	Tacoma	WA	98444	(253) 538-1688	ALB0493
FM-385	AFCFC	7250 Pacific Ave.	Tacoma	WA	98408	(253) 475-6040	FM-385
SAF1407	AFCFC	705 Trosper Rd SW	Tumwater	WA	98512	(360) 705-3569	SAF1407
SAF1449	AFCFC	501 North Miller St.	Wenatchee	WA	98801	(509) 663-5336	SAF1449
SAF0502	AFCFC	5702 Summitview Ave	Yakima	WA	98908	(509) 965-3622	SAF0502
PTA001	AFCFC	1005 Eagle Ridge Dr.	Prescott	WI	54021	(715) 262-5636	PTA001

Zenshi Food Service Counters
List of Franchisees Who Transferred
As of March 31, 2025

FC Name	Address	City	State	Zip	Phone
PINMANEE, Chanaporn	11825 Spylglass Cir	Anchorage	AK	99515	(907) 250-0919
MACAPINLAC LLC.	1649 N. Heather Meadows	Anchorage	AK	99507	(907) 942-2799
CHOUUMMITTAPHANH, Paul	1128 Joyce Drive	Fairbanks	AK	99701	(907) 978-3693
TUN, Kyaw Kyaw Naing	5402 Golden Pond Ave.	Northport	AL	35473	(603) 438-8584
AUNG, SKYLER	628 Garrett Drive	Prattville	AL	36066	(707) 917-0594
AUNG, SKYLER	628 Garrett Drive	Prattville	AL	36066	(707) 917-0594
CYO LLC.	11523 E Primrose LN	Florence	AZ	85132-7617	(310) 713-5383
THA, Biak	4232 W Tuckey LN	Phoenix	AZ	85019	(480) 859-1951
KYAW, Saw Type Pue	7224 E Freestone Rd.	Tucson	AZ	85730	(517) 249-9311
KYAW, Saw Type Pue	7224 E Freestone Rd.	Tucson	AZ	85730	(517) 249-9311
T & M INC.	815 Lincoln Avenue	Alameda	CA	94501	(510) 928-6898
ANG, Chris Htet	925 S. 2nd St.	Alhambra	CA	91801	(323) 986-9062
K AND T FOOD SERVICE LLC.	238 E. Elmwood Ave Apt # C	Burbank	CA	91502	(702) 513-4599
HFS THREE UNCLCS INC.	5644 Shadow Ridge Dr.	Castro Valley	CA	94452	(510) 963-8093
SUSHIME LLC.	17822 Noran Circle	Cerritos	CA	90703	(562) 291-8618
SUSHI SORA INC.	2528 Flinn Springs Rd	Chula Vista	CA	91915	(619) 961-3891
NANSHAY THU LLC US	7512 Chula Vista Dr.	Citrus Heights	CA	95610-5721	(916) 509-6868
KIERO SUSHI INC.	50-419 S Balboa St	Coachella	CA	92236	(760) 485-8480
CHO, Htin	3281 Tioga Rd.	Concord	CA	94518	(925) 490-6380
A&L CORPORATION	1850 Hanover Dr	Davis	CA	95616-1040	(415) 205-5127
JIN HUA CHEN LLC.	1553 Rebecca Ln.	El Cajon	CA	92019	(619) 808-6803
OO, Khin Aye	1074 St. Andrews Dr	El Dorado Hills	CA	95762	(650) 520-5642
MU PAING CORP.	8184 Crystal Walk Cir	Elk Grove	CA	95758	(415) 666-6217
HTUN, Moe Zaw	41314 Ellen St	Fremont	CA	94538	(925) 785-2401
MAUNG, Myint	3939 Monroe Ave	Fremont	CA	94536	(510) 304-1349
KJS FOOD SERVICE INC.	2256 Loma Verde Dr.	Fullerton	CA	92833	(213) 235-5311
THU, Nay Myo	18491 Kentwood Place	Hidden Valley Lake	CA	95467-8005	(530) 798-8343
TAMIS KITCHEN INC.	262 Roosevelt	Irvine	CA	92620-3615	(858) 285-9509
BOAZ ONE LLC.	24 Calais	Irvine	CA	92602	(949) 525-2770
GT FASHION INC.	10 Santa Catalina Aisle	Irvine	CA	92606	(213) 700-1851
KIM, Do Youn	24544 Copper Cliff Ct.	Lake Forest	CA	92630	(949) 813-8422
HEIN, Dae War	2005 Via Encanto	Lomita	CA	90717	(626) 734-2397
HRANG, Daniel Bawi	400 S. Berendo St.	Los Angeles	CA	90020-2108	(269) 419-9724
KIMYI LLC.	717 West Olympic Blvd.	Los Angeles	CA	90015	(213) 268-7878
KIMYI LLC.	717 West Olympic Blvd.	Los Angeles	CA	90015	(213) 268-7878
LUCKYBEAN INC.	810 S Flower St.	Los Angeles	CA	90017	(213) 716-4386
REDIM CORP.	525 S La Fayette Park Pl. #302	Los Angeles	CA	90057	(213) 276-6161
LUNG SENG LLC.	27483 Moonstone PL	Moreno Valley	CA	92555-4578	(817) 682-5758
JUST SUSHI LLC.	17875 Calle Tierra	Morgan Hill	CA	95037	(408) 466-8237
LIAN SUSHI BAR LLC.	9925 Bernhardt DR	Oakland	CA	94603-2019	(510) 851-2118
HTUN, Mie Mie	5632 Bolton Way	Rocklin	CA	95677-2571	(408) 489-3995
SPRING ZAW INC.	7435 Patero Cir.	Sacramento	CA	95823	(314) 402-7659
LEE SUSHI CORP.	3780 Madera Way	San Bruno	CA	94066	(415) 515-9809
MAYCO INC.	11018 W. Ocean Air Dr.	San Diego	CA	92130	(949) 517-8772
MEE MEES SUSHI LLC.	266 Denslowe Dr	San Francisco	CA	94132-2648	(415) 308-2900
MEEPO CORP.	1055 N Capitol Ave	San Jose	CA	95133-2714	(626) 637-7151
MITAKASA, INC.	1326 W Park Western Dr	San Pedro	CA	90732	(310) 619-0879
HOPIN113 LLC.	113 Meadowview Lane	Santa Cruz	CA	95060	(650) 255-2158
MANDALAY SUSHI	9748 San Remo CT.	Santee	CA	92071 - 2679	(619) 358-5118
SOOSHIE LLC.	174 Tuscanny Pl	Sonoma	CA	95476	(650) 931-5256
PHYU, Aye Myat	174 Tuscany Pl	Sonoma	CA	95476-6378	(415) 596-8962
HEIN NADI LLC.	1209 Ayala Dr.	Sunnyvale	CA	94086-5526	(916) 673-8628
YUN, Eric	12457 Gladstone Ave.	Sylmar	CA	91342	(213) 952-4000
LUCKY SUSHI INC.	45208 Palmira Cir.	Temecula	CA	92592	(678) 435-3768
LUCKY SUSHI INC.	45208 Palmira Cir.	Temecula	CA	92592	(678) 435-3768
RAFI SUSHI	20621 DESERT ASH LN	WINNETKA	CA	91306	(646) 238-7287
BADA ONE CORPORATION	21500 Califa St. Apt 96	Woodland Hills	CA	91367-4952	(224) 628-6546
KAP, Do Lian	1408 Sandalwood Dr	Colorado Springs	CO	80916	(208) 293-6012
KOIRALA, Hareram	17385 E Rice Cir	Aurora	CO	80015	(720) 767-9400
KOIRALA, Hareram	17385 E Rice Cir	Aurora	CO	80015	(720) 767-9400
TUN, Ko Ko	10702 E Exposition Ave.	Aurora	CO	80012	(720) 403-1294
TUN, Ko Ko	10702 E Exposition Ave.	Aurora	CO	80012	(720) 403-1294
HYT21 INC.	16435 Alcott PL	Broomfield	CO	80023	(858) 229-2918
RCNJ COMPANY INC.	16435 Alcott Pl.	Broomfield	CO	80023-8920	(972) 977-1112
OCEAN SUSHI, INC.	650 Coveglen Ct.	Colorado Springs	CO	80906-6371	(719) 761-8564
KO, Ko	1009 Cypress Dr.	Fort Collins	CO	80521-4113	(808) 250-6757
KO, Ko	1009 Cypress Dr.	Fort Collins	CO	80521-4113	(808) 250-6757
KYAW, Thura	5 Quail Dr	Tariffville	CT	06081	(917) 435-8303
TSAI, Yaohuo	1275 Winsted Rd	Torrington	CT	06790	(929) 302-0792
YAWONGTSANG, Tenzin	10 Palmer St.	Uncasville	CT	06382	(860) 383-9466
VAN L. H. CUANG, LLC.	7114 Paradiso Drive	Apollo Beach	FL	33572-1622	(813) 786-9403

Zenshi Food Service Counters
List of Franchisees Who Transferred
As of March 31, 2025

FC Name	Address	City	State	Zip	Phone
PYINTPHYOTUN INC.	3921 Sunshine Pine Ave	Bradenton	FL	34203-2117	(941) 726-8792
THEIN, Hla	4129 SW 7th Ave	Cape Coral	FL	33914-5889	(786) 831-2915
SUSHI PEARL INC.	13201 Olesen Ct	Clermont	FL	34711	(407) 234-4784
INARIMAKI FOJU LLC.	4119 NW 88th Ave	Coral Springs	FL	33065-1878	(407) 860-3781
MANDALAY MYANMAR INC.	5729 N.W. 48th Ct.	Coral Springs	FL	33067	(954) 558-2508
HAU THANG ENTERPRISES, INC.	1717 Shadow Trace Way	Deland	FL	32720	(407) 325-8385
KO, Khin	10660 Clear Lake Loop	Fort Myers	FL	33908	(347) 437-7440
SANG, OBED	18412 Fuchsia Rd	Fort Myers	FL	33967-3202	(239) 200-9708
WIN, Tun Tun	929 NW 87th Dr.	Gainesville	FL	32606	(850) 814-1141
KA MEXI-THAI INC.	427 Papaya St., Unit 366	Goodland	FL	34140	(239) 537-6559
SIANZUUN SUSHI LLC.	6806 Friendship Fountain Ave.	Jacksonville	FL	32217	(352) 620-4531
MANG, Kam Lam	3626 NW Adriatic Ln	Jensen Beach	FL	34957-3111	(202) 718-4428
FUTURELIFE INC.	5727 La Gorce Cir	Lake Worth	FL	33463	(561) 704-9432
MAWI, Za Hlei	2339 Miles CT	Lakeland	FL	33812	(813) 735-5630
LIAN, Joshua Van	601 Rosery RD NE	Largo	FL	33770-3818	(404) 934-7791
LIAN, Joshua Van	601 Rosery RD NE	Largo	FL	33770-3818	(404) 934-7791
PAZ L. MYERS ENTERPRISE INC.	33702 Warren Avenue	Leesburg	FL	34788	(352) 327-1777
HANG & SU BLESSED INC.	1043 NW 2nd Street	Miami	FL	33128	(786) 389-7411
HAU SUSHI INC.	14029 SW 155th Terrace	Miami	FL	33177	(786) 620-5875
MORALES RIVERO, Carlos Rafael	1700 Woodbury Rd	Orlando	FL	32828	(407) 492-8328
ISLAND SUNRISE INC.	12833 Oulton Circle	Orlando	FL	32832	(407) 271-1022
RUPPECTH SUSHI 448 LLC.	2346 Naples Trace Cir. Unit 8	Naples	FL	34109	(305) 487-1842
RUPPECTH SUSHI 448 LLC.	2346 Naples Trace Cir. Unit 8	Naples	FL	34109	(305) 487-1842
ZWT INC.	121 Cohosh Rd.	Nokomis	FL	34275-6803	(941) 544-9650
HARRY LIN SUSHI INC.	2774 Wesleyan Dr	Palm Harbor	FL	34684	(727) 225-4055
AUNG FAMILY ENTERPRISES INC.	140 Eureka Ave. NE	Palm Bay	FL	32907	(321) 890-5001
AUNG FAMILY ENTERPRISES INC.	140 Eureka Ave. NE	Palm Bay	FL	32907	(321) 890-5001
CINDY & CHO LLC.	3523 Hampshire Court	Palm Harbor	FL	34685	(727) 203-1358
YAWBAW INC.	301 SW 72nd Ave	Pembroke Pines	FL	33023	(954) 744-2185
YAWBAW INC.	301 SW 72nd Ave	Pembroke Pines	FL	33023	(954) 744-2185
MANG PA THUPHA INC.	11800 NW 14th St	Pembroke Pines	FL	33026	(954) 391-3943
KOSHI SUSHI LLC.	6053 Twenty One Oak Dr	Pensacola	FL	32526-4453	(585) 489-1399
ZAWL LUI INC	871 NW 85th Terrace	Plantation	FL	33324	(954) 300-8728
ZAWL LUI INC	871 NW 85th Terrace	Plantation	FL	33324	(954) 300-8728
Dinh, Anh Nguyet Thi	24531 Sunrise Dr.	Port Charlotte	FL	33980	(510) 759-6406
A1 SUSHI CORP.	8996 SW REMY LN.	PORT ST. LUCIE	FL	34987-5827	(561) 601-3719
TUTTLE, Orathai	467 S. Aberdeenshire Dr.	Saint Johns	FL	32259	(772) 634-7596
BLESSING SUSHI LLC.	114 Mercutio Ln	St. Augustine	FL	32092-4530	(904) 240-2982
Hlaing, Ba	7923 Limestone LN	Sarasota	FL	34233-3250	(929) 334-6720
J MC SUSHI INC.	8040 Conservatory Cir.	Sarasota	FL	34243	(941) 402-2222
LIAN, Siang Van	4300 Sunbeam St	Sebring	FL	33872	(515) 867-1773
LIAN, Siang Van	4300 Sunbeam St	Sebring	FL	33872	(515) 867-1773
WASHA FAMILY LLC.	2809 Little Deal Rd	Tallahassee	FL	32308-3821	(203) 721-5793
ZWE KA PIN INC.	8348 Yellow Lane	Tallahassee	FL	32311	(850) 980-2296
ZHANG, Yan	6046 Plow Trail	Tallahassee	FL	32317-7240	(850) 567-1465
PLUS ONE ASSOCIATES, INC.	503 E Jackson St	Tampa	FL	33602	(813) 324-0500
LIN, Swe Zin	1310 Laurel Ave	Venice	FL	34285	(941) 402-6687
SEEWEED SEE CORPORATION	13385 Avensong lves Way	Alpharetta	GA	30004-4999	(678) 200-9899
ZHU, Denghui	715 Fieldcrest Park Ln	Alpharetta	GA	30004-1447	(305) 457-7051
ZINGHMHU INC.	3241 Riverstone Dr.	Augusta	GA	30907	(706) 496-0664
NIANG, Cingh Khan	3088 Lantana Way	Buford	GA	30519-2018	(904) 713-1711
GYI ZU DAW INC.	1543 Wells Dr	Columbus	GA	31906	(803) 743-6147
SHALOM NL LLC.	1841 Vidalia Court	Dacula	GA	30019	(770) 568-1764
LTWO CHOSEN LLC.	1016 N. Letitia Ave	Douglas	GA	31533	(317) 516-8309
PHOENIX SUSHI INC.	5638 Elwood Circle	Flowerly Branch	GA	30542	(678) 200-6386
THU, Maung Myo Kyaw	1187 Button Buck Ln	Grovetown	GA	30813-2296	(803) 270-9135
JIELI COMPANY LLC.	4790 Sierra Creek Dr	Hoschtown	GA	30548	(678) 557-2680
SIANSINTHU	2411 Greenhouse Patio DR NW	Kennesaw	GA	30144-5862	(918) 859-5677
TRAN SUSHI LLC.	4465 Callaway Crest Dr NW	Kennesaw	GA	30152	(770) 364-9395
LIANUKTHANG, Dolly Rosemary	301 N Gross Rd.	Kingsland	GA	31548 - 7041	(269) 832-4957
RE J FOUR INC.	2664 Pierce Brennen Ct	Lawrenceville	GA	30043	(770) 815-8884
RE J FOUR INC.	2664 Pierce Brennen Ct	Lawrenceville	GA	30043	(770) 815-8884
ZAM, Lal Blak	655 Burnham Ridge	Lawrenceville	GA	30046	(404) 502-4388
GRAB N GO SUSHI LLC.	3229 Long Iron Dr.	Lawrenceville	GA	30044-2581	6787402597
TAM, Antonio Kwok	2174 Oakland Farm Drive	Lawrenceville	GA	30044	(678) 677-9077
ZOMI LEH VAPHUAL LLC.	5632 Four Winds Dr. SW	Liburn	GA	30047-6418	(678) 333-9665
ZOMI LEH VAPHUAL LLC.	5632 Four Winds Dr. SW	Liburn	GA	30047-6418	(678) 333-9665
SHANN, Richard Y.L.	2955 Nestle Creek Dr.	Marietta	GA	30062	(678) 992-4487
FRESH SUSHI LIMITED LIABILITY COMPA	7108 Double Pine CT	Midland	GA	31820-6315	(706) 888-7349
THANG, Lal Hruai	3920 Ancroft Cir.	Peachtree Corners	GA	30092	(404) 492-1736
UMAI SUSHI LLC.	8 Berryrun Dr	Rome	GA	30165	(626) 731-3928

Zenshi Food Service Counters
List of Franchisees Who Transferred
As of March 31, 2025

FC Name	Address	City	State	Zip	Phone
ZAM THANG, Suan	11102 Heroes Way	Savannah	GA	31419	(912) 227-4073
KAZU ENTERPRISES LLC.	263 Angla Dr SE	Srmyna	GA	30082	(803) 417-2029
CUNG, Joseph	1135 Hunters Dr.	Stone Mountain	GA	30083	(678) 367-9114
CUNG, Joseph	1135 Hunters Dr.	Stone Mountain	GA	30083	(678) 367-9114
CUNG, Joseph	1135 Hunters Dr.	Stone Mountain	GA	30083	(678) 367-9114
SHIN, Ho Sub	5287 Blossom Brook Dr	Sugar Hill	GA	30518	(678) 276-6465
THANG, Khai Min	3625 Sheffield Pl	Tucker	GA	30084	(404) 247-2663
NZ FAMILY INC.	230 Nohea St.	Hilo	HI	96720-5347	(682) 553-6240
LIAN, Van Uk	1146 Hakina Pl	Wailuku	HI	96793-2707	(317) 908-4273
MOO, Saw La	8673 W Stirrup St	Boise	ID	83709	(208) 371-8718
KHUPPI LION CORP.	625 Holbrook DR	Idaho Falls	ID	83401-4165	(208) 957-0557
KHUPPI LION CORP.	625 Holbrook DR	Idaho Falls	ID	83401-4165	(208) 957-0557
PAR, Tha Hlawn	446 Flint Trail	Carol Stream	IL	60188-1444	(469) 742-1251
PAR, Tha Hlawn	446 Flint Trail	Carol Stream	IL	60188-1444	(469) 742-1251
KUNG, Tuan	725 Greenway Ave	Colona	IL	61241	(309) 749-5926
KUNG, Tuan	725 Greenway Ave	Colona	IL	61241	(309) 749-5926
ZUAL, Cherry Mawi	907 E Central Rd	Mount Prospect	IL	60056	(701) 238-4342
TSING YAKI, INC.	1642 Frontier Dr.	Normal	IL	61761	(312) 898-7568
TSING YAKI, INC.	1642 Frontier Dr.	Normal	IL	61761	(312) 898-7568
NAWL, Biak	507 Westwood Dr	Wheaton	IL	60187	(630) 220-4052
ZOMI DYNASTY, INC.	575 Denoyer Trl	Wheeling	IL	60090	(847) 275-4376
HLAWNCEU, Tin Mang	3426 W Pointe Dr.	Elkhart	IN	46514	(574) 252-1787
TUN, Saw H.	803 Pine Lake Drive	Greenwood	IN	46143	(347) 520-2803
KIM, Van Nuam	6528 Hot Springs Lane	Indianapolis	IN	46217	(765) 615-1541
PAR, Cung Lian	7155 Barnwell Pl.	Indianapolis	IN	46217	(317) 767-9720
LIAN, Kham Za	5236 S Capitol Ave.	Indianapolis	IN	46217	(620) 765-0250
LIAN, Kham Za	5236 S Capitol Ave.	Indianapolis	IN	46217	(620) 765-0250
LIAN, Bawi	306 E Hill Valley Dr.	Indianapolis	IN	46227	(317) 741-1329
BIAK VUNG LLC.	3923 Rue Renoir	Indianapolis	IN	46220	(843) 290-2356
BIAK VUNG LLC.	3923 Rue Renoir	Indianapolis	IN	46220	(843) 290-2356
LO, Va Thla	1506 Vale Park Rd	Valparaiso	IN	46383-2742	(317) 250-9740
ZOU, Amy	4315 Bellmore St.	Bel Aire	KS	67220	(316) 305-6552
NWEE, Naw Phaw	4315 Bellmore St	Bel Aire	KS	67220-1809	(641) 691-3615
LIAN, Philip Rai Bawi	7921 Yecker Ave	Kansas	KS	66109	(402) 201-8237
THANG, Miriam Ct	612 N Salisbury Ct.	Lawrence	KS	66049	(785) 304-8165
MAR, Cho Cho	505 N Rock Rd	Wichita	KS	67206	(316) 371-4868
THANG, Ngun Ling	702 Freeman Lake Rd	Elizabethtown	KY	42701	(502) 762-8801
CHAN, Rebecca	3623 Keystone Ct.	Lexington	KY	40517	(502) 202-6165
ZAN, Aung Myo	1724 Farmview Dr	Lexington	KY	40515	(609) 575-6384
LIAN, Philip Van	8019 Judge Blvd.	Louisville	KY	40219	(502) 644-2720
LAMUNG, Ah Hkawn	121 Kingston Ave, Apt 1	Louisville	KY	40214	(602) 422-0266
LAMUNG, Ah Hkawn	121 Kingston Ave, Apt 1	Louisville	KY	40214	(602) 422-0266
KAP, Thang Khen	11505 Andalee DR	Louisville	KY	40272-4903	(502) 999-1812
HNING, Gi	5213 Famous Way	Louisville	KY	40219-4507	(502) 881-1125
LAI NAWL, Siang Lian Hmung	28431 Natchez Trace	Denham Springs	LA	70726-6453	(515) 393-9591
CIN, Ngun Cer	1129 Papworth Ave	Metairie	LA	70005-2338	(317) 995-0880
LEN, San	2001 Valentine Ct.	New Orleans	LA	70114	(504) 645-2272
LWIN, Zarli	111 Mary Coburn Rd	Springfield	MA	01129-2010	(415) 810-3884
TUN, Sunny	70 Shawmut St.	Chelsea	MA	02150	(857) 389-2076
HIMALAYAN SUSHI INC.	667 Saratoga St	East Boston	MA	02128	(347) 977-2288
LYNN, Tin	10 Highland Ave.	Fairhaven	MA	02719	(508) 916-8431
KO, Aung Ko	225 Silver St	Greenfield	MA	01301-1482	(937) 432-8491
SU, Ma Su	512 W. Edwards Ave	Houghton	MI	49931	(779) 205-5556
MAUNG, Yarzar Maung	2908 Crestwood Dr. NE	Alexandria	MN	56308-7973	(214) 677-6229
WANGDUE, Tsering	5300 Vernon Ave. S	Edina	MN	55436	(929) 418-5690
HAWJ SUSHI LLC.	1097 Forest St.	St. Paul	MN	55106	(907) 310-9499
HAWJ SUSHI LLC.	1097 Forest St.	St. Paul	MN	55106	(907) 310-9499
TLUANGI, Zo Than	4620 E. Summerhill Dr.	Columbia	MS	65202	(573) 777-2743
TLUANGI, Zo Than	4620 E. Summerhill Dr.	Columbia	MS	65202	(573) 777-2743
CHIN, Biak Sung	1320 E Edgewood St.	Springfield	MS	65804	(417) 576-5787
LUM, Gyung	706 Haffman Mill RD	Burlington	NC	27215-5141	(601) 954-0023
LIAN, David	1333 Bunnievel Erwin Rd	Bunnievel	NC	28323	(336) 554-0335
CIN, Lo Delh	7501 Rolling Hill Rd	Charlotte	NC	28227	(706) 566-9394
CING, Niang Khan	410 Hefflin St	Charlotte	NC	28205	(704) 458-1296
MUTAW, Kaw	9724 E W T Harris Blvd.	Charlotte	NC	28227	(980) 308-4538
NAING, Win Thein	4608 McKee Rd	Charlotte	NC	28270	(518) 488-4758
NINI SUSHI ENTERPRISES INC.	6 Sandhill Lane	Durham	NC	27713	(919) 423-6957
KUK, Sui	1610 Elkhart CIR	Gastonia	NC	28054-7745	(817) 781-7003
NAING, Soe	2611 Cashwell Dr	Goldsboro	NC	27534-4224	(843) 338-5066
REN, Youhang	3947 Center Place Dr	Harrisburg	NC	28075	(704) 605-8949
DHJNTUN SUSHI LLC.	23685 Camp Monroe Rd	Laurel Hill	NC	28351	(432) 312-5172

Zenshi Food Service Counters
List of Franchisees Who Transferred
As of March 31, 2025

FC Name	Address	City	State	Zip	Phone
PIYINAE, Pohsar	109 Tigris Court	Mooresville	NC	28117-8833	(252) 675-0776
MOLO, Podah S	2411 Meadowbrook Ave.	New Bern	NC	28562 - 5384	(252) 229-0800
HTOO, Eh	2141 Stonehenge Dr.	Raleigh	NC	27615	(984) 484-1488
LIAN, Zatling	17 Birch Pong Rd	Shallotte	NC	28470	(317) 500-7359
ZAZA INC.	530 Kensington Rd	Southern Pines	NC	28387-5825	(432) 847-9732
GX LLC.	7456 Courtney Pines Rd	Wilmington	NC	28411-7235	(980) 221-7612
CUNG, Lyan	6907 Oak Plaza	Omaha	NE	68106 - 3428	(727) 657-4745
SUNG, Bawi Tha Hnem	11422 Nebraska Cir	Omaha	NE	68164	(531) 247-9158
SUNG, Bawi Tha Hnem	11422 Nebraska Cir	Omaha	NE	68164	(531) 247-9158
FAM, Ngun Tha	10259 Ohio St	Omaha	NE	68134	(402) 213-8009
NGE, Nu Nu	9505 Flint Rock Drive	Albuquerque	NM	87114	(806) 443-3375
NGE, Nu Nu	9505 Flint Rock Drive	Albuquerque	NM	87114	(806) 443-3375
NGE, Nu Nu	9505 Flint Rock Drive	Albuquerque	NM	87114	(806) 443-3375
VICO, Justin	944 Broadway	Rensselaer	NY	12144	(917) 751-0752
J&Z SUSHI LLC.	47 Hillcrest Rd.	Tonawanda	NY	14150-3923	(716) 930-1092
JE JUCHAN	6251 Lanier St.	Albany	OR	97321	(541) 914-0919
S.B, Hau Pau	2515 S.W. East Wood Avenue	Gresham	OR	97080	(971) 227-5654
LINS SUSHI LLC.	450 MIDWAY RD	MEDFORD	OR	97501-1987	(541) 816-0387
KYAW ZIN, Min	16811 SE Francis St.	Portland	OR	97236	(971) 900-7721
SIAN HAWM LLC.	2050 SE 171st Ave	Portland	OR	97233	(971) 481-8490
ETHAN KWAH KYI LLC.	52499 SE 4th St	Scappoose	OR	97056	(971) 413-0602
ZEZAWAR LLC.	33230 SW Maple St	Scappoose	OR	97056	(503) 791-3244
WANG SUSHI INC.	20 Heather Glenn In.	Bluffton	SC	29910	(513) 907-5978
HRANG, Lian	3430 Kay St Apt E4	Columbia	SC	29210	(806) 282-9248
THEIN, Daniel	644 Kent Ln	Myrtle Beach	SC	29579	(910) 616-7973
BANG, Joane	3562 Battery Way CT	Myrtle Beach	SC	29579-7535	(702) 981-0286
JENSEN, Moses Lungtoem	1512 Kippford Way 0524	Myrtle Beach	SC	39579	(904) 600-2891
MAWI, Lal R.	4032 Keeley Dr.	Antioch	TN	37013-3562	(615) 803-0569
THET, John	6159 Brentwood Chase Dr	Brentwood	TN	37027	(615) 585-8194
THET, John	6159 Brentwood Chase Dr	Brentwood	TN	37027	(615) 585-8194
HNIANG, Hrin	537 Bellany Lane	Clarksville	TN	37043	(317) 332-2928
SANN FAMILY INC.	494 W 6TH Street	Cookeville	TN	38501-1690	(937) 405-8810
ZION LEGEND CORP.	1212 Viking Dr.	Knoxville	TN	37932	(865) 308-8332
THAWN, Thang Khat	829 Ridgetop Dr.	Mount Juliet	TN	37122	(615) 364-0568
KIM, Suan	230 Ocala Dr.	Nashville	TN	37211	(615) 403-3888
KHAI, Piang Thawn	515 Smokey Ridge	Nolensville	TN	37135-1723	(615) 668-8429
LAM, David	1004 Cedarstone Ct	Smyrna	TN	37167-5951	(706) 833-3591
HEITUI SUAN INC.	409 Spitzly Ln	Smyrna	TN	37167-2972	(615) 974-9853
KHAI, Cin Khat	9003 Capshaw St.	Smyrna	TN	37167 - 7404	(615) 578-4055
NUAM, Sang Za	119 Split Rail Ln	Spring Hill	TN	37174	(615) 424-0892
THAWNG, Van Ram	2621 Maria Casas St.	El Paso	TX	79938-2372	(214) 723-0521
UK, Tha Kip Sui	2232 Dana Dr	Flower Mound	TX	75028	(214) 316-1699
VAN BROTHERS LLC.	2608 Winding Path Way	Flower Mound	TX	75022	(972) 974-1997
CHUAN, Mang Bawi	3418 Ridgemoor Dr.	Gorland	TX	75044	(469) 503-5199
CHUAN, Mang Bawi	3418 Ridgemoor Dr.	Gorland	TX	75044	(469) 503-5199
KHUN, Tha	1105 N18th St.	Killeen	TX	76541	(254) 393-7361
ZI, Amy Siang	1553 Eilka Court	Lewisville	TX	75067	(214) 462-5210
SUNG, Nu	6600 Mckinney Ranch Pkwy	Mckinney	TX	75070	(469) 831-9548
THAWNG, Lian Bik	1505 S Redbud St.	Pecos	TX	79772	(432) 212-1113
STONE OAK MINI MALL, INC.	8910 LOST WOODS	SAN ANTONIO	TX	78240	(210) 772-4564
MATUTAKLUEM & CHI CHI INC.	1502 N. 200 W	Bountiful	UT	84010	(801) 558-8365
DALA THAR	724 Shamrock Rd.	Charlottesville	VA	22903	(434) 227-8768
M&K FOODS AND TRADING SERVICES LLC.	435 Dorset St.	South Burlington	VT	5403	(315) 749-5393
HTWE, Mawi	4340 S. 291st Street	Auburn	WA	98001	(253) 886-6434
OO, Shwe Wathan	3200 Capitol Mall Dr. SW	Olympia	WA	98502	(478) 319-4982
LEE, Yongsook	4402 Henderson Blvd. SE	Olympia	WA	98501-4664	(310) 951-6302
LIAN, Cin Suan	1150 Union Ave NE	Renton	WA	98059	(206) 574-8244
JEWEL ZIN LLC.	705 Riverside Dr.	Wenatchee	WA	98801 - 2585	(352) 301-0700
THA, Saw Hla Win	320 King Street	Wenatchee	WA	98801-2868	(860) 656-5108

Zenshi Food Service Counters
Terminated List
As of March 31, 2025

Franchisee Name	Address	City	State	Zip	Phone
BAWI, Chan	2417 Tongass Ave	Ketchikan	AK	99901	(907) 228-1900
HMUNG, Biak Nuai	8000 Madison Blvd	Madison	AL	35758	(256) 461-1860
TUANG, Khup Lam	7129 Wall Triana Hwy	Madison	AL	35757	(256) 722-3786
CHUNG, Ngun	1190 University Blvd	Tuscaloosa	AL	35401	(205) 247-5044
CHUNG, Ngun	4851 Rice Mine Rd NE Ste 200	Tuscaloosa,	AL	35406	(205) 247-7666
MUANG, Pau Sian	1201 South Plaza Way	Flagstaff	AZ	86001	(928) 779-3401
MOON, Jeong Hee	3325 North Hunt Highway	Florence	AZ	85132	(520) 723-0179
KOP, Pom Khan	3970 Stockton Hill Rd	Kingman	AZ	86409	(928) 681-4900
KYAW, Aung	6965 N Hayden Road	Scottsdale	AZ	85250	(480) 991-9707
SUNG, Tial Chin	7920 E. Chaparral Rd.	Scottsdale	AZ	85250	(480) 532-8588
AUNG, Nge Nge	2300 West Highway 89A	Sedona	AZ	86336	(928) 282-0118
Lamigo, Jerry Jansen	3365 Deer Valley Rd	Antioch	CA	94531	(925) 706-4150
HLA, Ye	9467 West Olympic Blvd	Beverly Hills	CA	90212	(310) 553-5734
HAN, Jingyuan	29675 The Old Road	Castaic	CA	91384	(661) 702-6911
KIM, Jin Young	13321 South St.	Cerritos	CA	90701	(562) 860-5635
MARAN, Margaret	21431 Devonshire St.	Chatsworth	CA	91311	(818) 341-0950
XU, Changming	2661 Green River Rd	Corona	CA	92882	(951) 371-4868
FAN, Yinwei	3496 Camino Tassajara	Danville	CA	94506	(925) 736-0298
ALVAREZ, Eddie Antonio	3828 N Peck Rd.	El Monte	CA	91732	(626) 442-8200
SHIN, Hyungak	500 N Sepulveda Blvd	El Segundo	CA	90245	(310) 615-0537
LEE, Yeon	125 N. El Camino Real	Encinitas	CA	92024	(760) 942-5472
MAW, Win Min	2401 Waterman Drive	Fairfield	CA	94533	(707) 427-5640
TUN, Danny	3920 Inner Loop Rd., Bldg. 920	Fort Irwin	CA	92310	(760) 380-3560
KIM, Jin Young	18405 Brookhurst St.	Fountain Valley	CA	92708	(714) 964-7566
KIM, Yong Sam	16940 Devonshire St.	Granada Hills	CA	91344	(818) 363-3173
KIM, Yong Sam	16940 Devonshire St.	Granada Hills	CA	91344	(818) 363-3173
YUN, Eric	521 W. Foothill Blvd.	La Canada	CA	91011	(818) 790-0584
ALVAREZ, Eddie Antonio	1305 W Whittier Blvd.	La Habra	CA	90631	(714) 507-7602
KIM, Bok Soon	8011 University Ave	La Mesa	CA	91942	(619) 464-1011
DORJNAMJIL, Bat-Orgil	29211 Heather Cliff Drive	Malibu	CA	90265	(310) 457-2401
SHANG, Chengwu	27730 Santa Margarita Pkwy	Mission Viejo	CA	92691	(949) 837-0380
NAING, Maung Myo	5877 Jarvis Ave.	Newark	CA	94560	(510) 713-3180
GAO, Peter	3075 S. Archibald Bldg	Ontario	CA	91761	(909) 947-1884
LIAO, Chyong-Ing	1435 W. Chapman Ave	Orange	CA	92868	(714) 634-2905
DEL SOCORRO, Maria Irene	2 CAMINO SOBRANTE	Orinda	CA	94563	(925) 254-8792
ZHENG, Xiankang	1025 Alhambra Blvd	Sacramento	CA	95816	(916) 456-0852
KYAW, Wunna	3680 Crocker Ave	Sacramento	CA	95818	(916) 285-8840
JO, Joseph Junbo	811 Avenida Talega	San Clemente	CA	92673	(949) 492-1648
WIN, Aye	MCAS Miramar Building 2661	San Diego	CA	92145	(858) 577-4516
AYE, Tin Nwe	5146 Stevens Creek Blvd.	San Jose	CA	95129	(408) 556-0610
MURAI, Misaki	1050 N. Western Ave.	San Pedro	CA	90732	(310) 833-3506
HTAY, Khin Maung	1211 W. College Ave	Santa Rosa	CA	95401	(707) 546-6877
BAUK, Jar	477 West Napa	Sonoma	CA	95476	(707) 996-0633
BAUK, Jar	1026 Hunt Ave.	St. Helena	CA	94574	(707) 968-3620
MAUNG, Myint	1356 S Mary Ave	Sunnyvale	CA	94087	(408) 212-4928
MAW, Win Min	2090 Harbison Drive	Vacaville	CA	95687	(707) 452-7277
CHIN, No Thluai	7655 McLaughlin Rd	Falton	CO	80831	(719) 495-7300
AUNG, Thura	731 South Lemay	Fort Collins	CO	80524	(970) 221-5845
AUNG, Thura	2160 W. Drake Road	Fort Collins	CO	80521	(970) 484-6048
AWI, Mang	1008 Summit Blvd	Frisco	CO	80443	(970) 668-5144
AUNG, Thura	1426 E. Harmony Road	Ft. Collins	CO	80525	(970) 223-6335
NAWL, Zion Za	681 Horizon Drive	Grand Junction	CO	81506	(970) 257-1392
CHIN, No Thluai	624 Highway 105	Monument	CO	80132	(719) 488-1187
CEU, Van Lian	5126 Community Center Dr.	USAF Academy	CO	80840	(719) 333-2025
AWI, Mang	2131 North Frontage Road	West Vail	CO	81657	(970) 476-3561
CHAIPILA, Monyakam	10301 SE US Highway 441	Bellevue	FL	34420	(352) 245-4115
MUNG, Pau Khan	26841 Tamiami Trail	Bonita Springs	FL	34134	(239) 992-0105
DIM, Lai	11600 W. Sample Rd.	Coral Springs	FL	33065-2646	(954) 509-5288
Drawitz, Annie Mueanfan	13860 South Jog Rd	Delray Beach	FL	33446	(561) 498-2229
HTIKE, Htike Aung	7375 W. Atlantic Ave	Delray Beach	FL	33446	(561) 498-2221
MYINT, Moe Saw	20321 Summerlin Rd	Fort Myers	FL	33908	(239) 454-0145
MYINT, Moe Saw	4791 Estero Blvd	Fort Myers Beach	FL	33931	(239) 463-0378
TANG, Chi Lung	5185 US Hwy 98 S	Lakeland	FL	33812	(863) 644-0386
LUN, Hau Za	8140 West Mcnab Rd	N Lauderdale	FL	33068	(954) 722-0599
SANG KUNG, Om Thang	4065 Hancock Bridge Rd	North Fort Myers	FL	33903	(239) 997-0212
OO, Kyaw	12195 S. Orange Blossom Trl	Orlando	FL	32837	(407) 816-0884
AUNG, Ko Ko	8725 Placida Rd	Placida	FL	33946	(941) 698-1699
TRAN, Canh Van	3941 Tamiami Trail	Punta Gorda	FL	33950	(941) 575-0793
AUNG, Ko Ko	1445 E Venice Ave	Venice	FL	34292	(941) 480-0779
PIANG, Sian	4075 North Haverhill Rd	West Palm Beach	FL	33417	(561) 683-0412
THANG, Thawng Lian	774 GA Highway 96	Bonair	GA	31005	(478) 988-5700
MAHKAW, Gam Htoi	5435 Woodruff Farm Rd	Columbus	GA	31907	(706) 568-8820
YU, Weina	2325 BETHELVIEW RD	CUMMING	GA	30040	(770) 888-1020
YU, Weina	2325 BETHELVIEW RD	CUMMING	GA	30040	(770) 888-1020
YANG, Zhen	5475 Bethelview Rd.	Cumming	GA	30040	(678) 455-1232
ZHENG, Jie	3316 Highway 5	Douglasville	GA	30135	(770) 920-3460
ZHENG, Jie	4300 Chapel Hill Rd.	Douglasville	GA	30135	(770) 577-5133
MANG, Thang Sian	1100 Hillcrest Pkwy	Dublin	GA	31021	(478) 277-3081
ZHANG, Qin	1625 Pleasant Hill Rd	Duluth	GA	30096	(770) 806-2780
ZHANG, Qin	2750 Buford Hwy	Duluth	GA	30096	(770) 622-6750
ZHANG, Qin	3870 Peachtree Industrial Blvd	Duluth	GA	30096	(770) 813-7465
PUM, Khua	6350 Lake Oconee Pkwy	Greensboro	GA	30642	(706) 454-7140
KIM, Jae J.	930 New Hope Rd.	Lawrenceville	GA	30045	(770) 682-2430
THANG, Thawng Lian	5928 Zebulan Rd.	Macon	GA	31210	(478) 757-4150
HUM, Cassidy Thaw	48 Bullsboro Dr.	Newnan	GA	30263	(770) 251-4791

Zenshi Food Service Counters
Terminated List
As of March 31, 2025

Franchisee Name	Address	City	State	Zip	Phone
KHAN, Ayub	130 Peachtree East Shopping Ctr.	Peachtree City	GA	30269	(770) 486-2020
GIM, Jing	3245 Peachtree Parkway	Suwanee	GA	30024	(770) 886-5335
GIM, Jing	7780 McGinnis Ferry Rd.	Suwanee	GA	30024	(770) 622-0218
KHALID, Khallat Majeed	7100 W state St.	Boise	ID	83714	(208) 342-2756
KHALID, Khallat Majeed	640 Highway 16	Emmett	ID	83617	(208) 365-4420
AYE, Tun	2203 East Oakland Avenue	Bloomington	IL	61701	(309) 663-4012
IANG, C C	1200 W Boughton Rd.	Bolingbrook	IL	60440	(630) 226-1892
LIANG, Jeffrey Hui	3400 N Western	Chicago	IL	60618	(773) 327-1204
LIAN, Martin	4729 N Central Ave	Chicago	IL	60630	(773) 777-1142
LIAN, Martin	4250 N. Lincoln Ave	Chicago	IL	60618	(773) 472-6171
LIANG, Xiao L.	1763 W. Howard	Chicago	IL	60626	(773) 274-1287
KIM, Tae Sook	3630 N Southport	Chicago	IL	60613	(773) 327-2330
MANG, Thang Thawn	3607 West Fullerton	Chicago	IL	60647	(773) 278-8355
MYO, Hnin Zar Chi	1220 S Ashland Ave	Chicago	IL	60608	(312) 733-0153
MYO, Hnin Zar Chi	370 North Desplaines Ave	Chicago	IL	60661	(312) 775-0991
LIANG, Xiao L.	1128 Chicago Ave	Evanston	IL	60202	(847) 869-7950
Kee, Nant S.	890 N. Western Ave.	Lake Forest	IL	60045	(847) 735-8018
LIANG, Jeffrey Hui	8900 N. Greenwood Ave	Niles	IL	60714	(847) 795-4600
MYO, Hnin Zar Chi	7525 W. Lake St.	River Forest	IL	60305	(708) 771-0044
Thein, Kyaw	3220 Chicago Rd.	S. Chicago Heights	IL	60411	(708) 755-7372
CANGMAH, Ram Cung Lian	199 Brookforest Ave	Shorewood	IL	60404	(815) 730-3944
TIN, John	200 N Vine St	Urbana	IL	61802	(217) 337-6016
LON, Nga	1250 W. Main St.	West Dundee	IL	60118	(847) 428-3355
OM, Thang K	145 South Eastwood Dr.	Woodstock	IL	60098	(815) 206-0499
THAWNG, James	1845 North Scatterfield Rd	Anderson	IN	46012	(765) 649-2276
CEU, Nei	3800 East Mishawaka Rd.	Elkhart	IN	46517	(574) 875-6211
THANG, Ni Lian	715 S. Tillotson Ave.	Muncie	IN	47304	(765) 213-1200
LO, Va Thla	1605 Calumet Ave.	Valparaiso	IN	46383	(219) 464-8606
LIAN, Ceu Cung	1300 Anderson Crossing Dr	Lawrenceburg	KY	40342	(502) 859-0234
HNEM, Sui	2200 Brownsboro Road	Louisville	KY	40206	(502) 897-1133
VILASA, FNU	301 Pond Street	Ashland	MA	01721	(508) 881-5125
KM, TEK BAHADUR	2040 Commonwealth Ave	Auburndale	MA	02466	(617) 965-1793
GAO, Qiong	535 Trapelo Rd.	Belmont	MA	02478	(617) 489-6540
ZOU, Mei Ya	1 Snow Road	Marshfield	MA	02050	(781) 837-5100
VILASA, FNU	230 Main St	Medfield	MA	02052	(508) 359-8713
ZAW, Myo Htet	7 Medway Road	Milford	MA	01757	(508) 422-9300
JANG, Se Won	45 Veterans Memorial Drive	North Adams	MA	01247	(413) 663-6549
CHOI, Hanna	130 Granite Street	Quincy	MA	02169	(617) 770-0841
ZAW, Myo Htet	62 W. Main Street	Spencer	MA	01562	(508) 885-0003
GAO, Qiong	1070 Lexington St.	Waltham	MA	02451	(781) 891-0615
ZOU, Mei Ya	610 Middle St	Weymouth	MA	02817	(781) 331-5108
CEU, Thawng	15501 Annapolis Rd, Ste 400	Bowie	MD	20715	(301) 383-2935
THOM TE, Cin Cin Pau	18169 Towncenter Dr.	Olney	MD	20832	(301) 260-1792
WIN, Genesis	1 Chandler Dr.	Bath	ME	04530	(207) 443-9179
WIN, Genesis	147 Bath Rd. Route 1	Brunswick	ME	04011	(207) 721-9996
HTOI, Awng	45 Gravois Bluffs Plaza Dr.	Fenton	MO	63026	(626) 343-1216
SANGTUALA, James	2101 Schotthill Woods Dr	Jefferson City	MO	65101	(573) 659-3600
SANGTUALA, James	2805 W Truman Blvd	Jefferson City	MO	65109	(573) 893-3111
HUALNGO, Zomawia	1801 Missouri Blvd.	Jefferson City	MO	65109	(573) 635-0753
TIN, U Tin	570 North Montana Street	Dillon	MT	59725	(406) 683-5002
VEN, Sang Bawi	611 N Montana Street	Helena	MT	59601	(406) 443-1598
SAN, Ngun Lin	117 W. Janeaux St.	Lewistown	MT	59457	(406) 538-5454
CUNG, Van Ro	940 US Highway 64 W	Apex	NC	27523	(919) 380-1422
UK, Van Thawng	1020 Bradford Plaza Way	Cary	NC	27519	(919) 460-2082
JAHAU, Lalchhanmawia	1817 Martin Luther King Jr. Pkwy.	Durham	NC	27707	(919) 489-9887
SMITH, William	3114 Raeford Rd.	Fayetteville	NC	28303	(910) 321-0114
TIN, Van	2120 E. Fire Tower Rd.	Greenville	NC	27858	(252) 355-0125
TIN, Van	University Commons	Greenville	NC	27834	(252) 353-4400
#N/A	635 Market Village	Hendersonville	NC	28792	(828) 694-4440
#N/A	6828 Matthews Mint Hill Road	Mint Hill	NC	28227	(704) 573-0234
REH, THAE	7400 Creedmoor Rd.	Raleigh	NC	27613	(919) 848-1464
MAWI, Cer	5365 Robinhood Village Dr.	Winston-Salem	NC	27106	(336) 923-2441
AUNG, Aung	3540 East Main Street	Farmington	NM	87402	(505) 327-3349
MANG, Kam Lian	2551 E. Lohman	Las Cruces	NM	88011	(575) 521-9837
LIAN, Sang Ceu	4200 Mountain Home St	Nellis AFB	NV	89191	(702) 632-5500
PHAWT, Naw Ail	5150 Mae Anne Ave.	Reno	NV	89523	(775) 746-9000
PHAWT, Naw Ail	5150 Mae Anne Ave.	Reno	NV	89523	(775) 746-9000
TUN, Zaw Lin	2351 MAPLE ROAD	AMHERST	NY	14221	(716) 515-3200
Kyaw, Saw Zaw Hla	2101 ELMWOOD AVENUE	BUFFALO	NY	14207	(716) 515-0050
Kyaw, Saw Zaw Hla	2101 ELMWOOD AVENUE	BUFFALO	NY	14207	(716) 515-0050
SEIN, Esther Om	1740 SHERIDAN DRIVE	BUFFALO	NY	14223	(716) 874-4991
ZAR, Htat Yar	71 NELSON STREET	CAZENOVIA	NY	13035	(315) 655-4565
TUN, Zaw Lin	3865 UNION ROAD	CHEEKTOWAGA	NY	14225	(716) 684-5927
TIN HLA, Kyu Kyu Mar	6914 ERIE ROAD	Derby	NY	14047	(716) 947-4019
TIN HLA, Kyu Kyu Mar	3955 VINEYARD DRIVE	Dunkirk	NY	14048	(716) 366-2050
ZAR, Htat Yar	350 Towne Dr.	Fayetteville	NY	13066	(315) 637-8039
LIAN, Mang	2140 Grand Island Blvd	Grand Island	NY	14072	(716) 775-1138
TUN, Han	3507 MT. READ BLVD	Greece	NY	14616	(585) 663-4400
ZAR, Htat Yar	119 WEST SENECA STREET	MANLIUS	NY	13104	(315) 682-7261
LIAN, Mang	301 Meadow Dr	North Tonawanda	NY	14120	(716) 743-4350
TUN, Han	1601 PENFIELD ROAD	Rochester	NY	14625	(585) 264-0820
ZAR, Htat Yar	620 NOTTINGHAM ROAD	SYRACUSE	NY	13224-2234	(315) 446-1652
Win, Pwint Su Wai	355 ORCHARD PARK RD.	West Seneca	NY	14224	(516) 517-3000
SEIN, Esther Om	5274 Main Street	Williamsville	NY	14221	(716) 632-7411
HAN, Kho Aung	1990 14th Ave. SE	Albany	OR	97322	(541) 812-2380

Zenshi Food Service Counters

Terminated List

As of March 31, 2025

Franchisee Name	Address	City	State	Zip	Phone
LEE, James A	6055 SW 185th Ave	Aloha	OR	97078	(503) 642-7059
HEAP, Needa	14555 SW Teal Blvd.	Beaverton	OR	97007	(503) 590-9755
PAITECHA, Orawan	1800 NE 3rd Street	Bend	OR	97701	(541) 382-3661
PI, Hon	138 W. Ellendale	Dallas	OR	97338	(503) 831-6000
TAKNAN, John Naylin	3333 W 11th Ave.	Eugene	OR	97402	(541) 484-4200
AUNG, Zaw Min	4701 Highway 101	Florence	OR	97439	(541) 902-7300
JUNG, Haengsoon	401 A Ave.	Lake Oswego	OR	97034	(503) 675-4480
KU, Say	4101 Logan Road	Lincoln City	OR	97367	(541) 994-8667
RODRIGUEZ-LOPEZ, Victor Manuel	1705 South Highway 97	Redmond	OR	97756	(541) 504-4160
KHE, Shwe	30300 SW Boones Ferry Road	Wilsonville	OR	97070	(503) 570-3509
KHAI, Hau Sian	1985 Folly Rd.	Charleston	SC	29412	(843) 762-6255
BIK, Bawi Thiang	1435 Ben Sawyer Blvd.	Mt. Pleasant	SC	29464	(843) 856-3018
KHAI, Pau	781 Main St.	North Myrtle Beach	SC	29582	(843) 249-9950
#N/A	BUILDING 407 WAKE BOULEVARD	Parris Island	SC	29905	(843) 228-2383
CIN, Thang Khan	1931 Long Hollow Pike	Gallatin	TN	37066	(615) 230-7647
LIAN, Robert	4400 Lebanon Pike	Hermitage	TN	37076	(615) 883-3317
TLUANGA, Benjamin	5928 Hixson Pike Ste 112	Hixson	TN	37343	(423) 847-8461
KHAI, Cin Sawm	4935 Columbia Pike	Spring Hill	TN	37174	(615) 302-4068
THA, Van Cer	1095 Judge Ely Blvd	Abilene	TX	79601	(325) 677-8527
THA, Van Cer	3301 S. 14th St.	Abilene	TX	79605	(325) 698-9391
SANG, WILLIAM	302 South Park Blvd	Grapevine	TX	76051	(817) 481-5669
KAP, Khai Za	12815 Indiana Ave	Lubbock	TX	79423	(806) 776-8900
LABYA, Hkawn N	10801 D. STREET BLDG 337	NAS CORPUS CHRISTI	TX	78419-5104	(361) 961-2545
THAWNG, Lian Biak	25401 East Gate Marketplace Plaza	Chantilly	VA	20152	(703) 722-2126
ONG, Francis	545 Radford Lane	Charlottesville	VA	22903	(434) 823-1184
SU, Wei L	237 Hanbury Rd. E.	Chesapeake	VA	23322	(757) 546-9074
CEU, John Biak Tin	7045 Forest Hill Ave	Richmond	VA	23225	(804) 323-4110
BLANCO, Thomas Dirk Cinco	2129 General Booth Blvd	Virginia Beach	VA	23454	(757) 427-6220
SOE, Than Lwin	14020 Main St. N.E.	DUVALL	WA	98019	(425) 844-1188
THANG, Richard Tuan Kip	510 Grant Rd	East Wenatchee	WA	98802	(509) 884-0707
THANGTHAT, Jedidiah B	5502 Point Fosdic Dr. NW	Gig Harbor	WA	98335	(509) 797-5750
HKUM, Seng	460 SW Mt Si Blvd	North Bend	WA	98045	(425) 831-2122
PUII, Lal Nun	4300 NE 4th Street	Renton	WA	98059	(425) 226-7666
KO, Htway Ko	516 1st. Ave. W.	Seattle	WA	98119	(206) 494-1685
NA, Elve	2507 W Wellesley	Spokane	WA	99205	(509) 327-4593
KHUP, Kham Khan	2509 E. 29th Ave	Spokane	WA	99223	(509) 532-0822
KHUP, Kham Khan	14020 E Sprague Ave	Spokane	WA	99216	(509) 921-9859
THANG, Richard Tuan Kip	501 North Miller St.	Wenatchee	WA	98801	(509) 663-5336

If you buy this franchise, your contact information may be disclosed to other buyers when you leave the franchise system.

Zenshi Food Service Counters
Non-Renewal List
As of March 31, 2025

FCName	FCHomeAddress	City	State	Zip	Phone
LIU, Shasha	4241 Birch Ln	Fairbanks	AK	99709	(907) 699-4022
ZOMI SANG NGAIHTE	119 Austin Street	Ketchikan	AK	99901 - 5948	(918) 521-0616
MANG, Lian	720 Barcelona Ct	Birmingham	AL	35209	(918) 257-2224
MANG, Lian	720 Barcelona Ct	Birmingham	AL	35209	(918) 257-2224
PAKATA, Naing	1433 W Isabella Ave	Mesa	AZ	85202	(702) 278-9587
PAKATA, Naing	1433 W Isabella Ave	Mesa	AZ	85202	(702) 278-9587
RAI, San Kyu	5235 N 43rd Ave.	Phoenix	AZ	85019	(602) 672-2547
YI	2846 N. 73rd Dr.	Phoenix	AZ	85035	(480) 376-4435
AUNG, Nwe Nwe	983 Princess way	Brentwood	CA	94513	(415) 676-8662
AUNG, Nwe Nwe	983 Princess way	Brentwood	CA	94513	(415) 676-8662
BARRON, Carolina Reando	521 Cypress Street	Fort Bragg	CA	95437	(707) 380-9981
VARDEH, Rounita	986 Almaden Lake Dr.	San Jose	CA	95123	(209) 416-6199
MUANG, Thang Suan	4576 Curtis Ave	Lake Worth	FL	33463	(561) 293-0952
TUANG, Gin Deih	3626 Eastgate DR	Savannah	GA	31404-4820	(912) 344-7928
LWIN, Moe Thauk Saw	823 N. Harlem Ave.	Oak Park	IL	60302	(708) 856-2354
ZAW, Thiha	2 S536 Cynthia Dr.	Warrenville	IL	60555	(248) 909-0162
SPEARMAN, Teresa Tolentino	16233 Cortez Ave.	Prairieville	LA	70769	(225) 323-0482
LATT, Aung	1365 Hazel Nut Court	Annapolis	MD	21409	(443) 699-2276
ZIN, Thet Htar	2414 Elm Dr	White Bear Lake	MN	55110-5576	(806) 341-7208
SHWE, U Thaug	3618 Tholozan Ave	Saint Louis	MS	63116	(314) 269-6880
WANG, Han	768 Hampshire Seet	Niskayuna	NY	12309	(518) 772-7126
WANG, Han	768 Hampshire Seet	Niskayuna	NY	12309	(518) 772-7126
LIAN, Heaven Thapeng	2701 SE 95th St	Moore	OK	73160-9156	(972) 815-7134
OO, Esther Lian	702 Old Village RD	Okatie	SC	29909-3960	(317) 654-2239
HOI HLAWNCHING INC	220 S. Barnes Dr.	Garland	TX	75042-7228	(214) 713-9287
HOI HLAWNCHING INC	220 S. Barnes Dr.	Garland	TX	75042-7228	(214) 713-9287
CHO & KIM LLC.	575 E. University Pkwy M204	Orem	UT	84097	(385) 225-5850
MALONG, Labya Naw Crawng	947 12th St. NE	Auburn	WA	98002	(206) 697-8657
DAM, Van Lal Chan	1137 N 94th St	Seattle	WA	98103	(206) 747-3527
DAM, Van Lal Chan	1137 N 94th St	Seattle	WA	98103	(206) 747-3527

If you buy this franchise, your contact information may be disclosed to other buyers when you leave the franchise system.

Zenshi Food Service Counters
List of Franchises Reacquired by Franchisor
As of End of March 31, 2025

Name	Address	City	State	Zip	Phone
BAWI, Chan	2417 Tongass Ave	Ketchikan	AK	99901	(907) 228-1900
HMUNG, Biak Nuai	8000 Madison Blvd	Madison	AL	35758	(256) 461-1860
MUANG, Pau Sian	1201 South Plaza Way	Flagstaff	AZ	86001	(928) 779-3401
MOON, Jeong Hee	3325 North Hunt Highway	Florence	AZ	85132	(520) 723-0179
KOP, Pom Khan	3970 Stockton Hill Rd	Kingman	AZ	86409	(928) 681-4900
KYAW, Aung	6965 N Hayden Road	Scottsdale	AZ	85250	(480) 991-9707
LITTLE RED ROCK INC.	2300 West Highway 89A	Sedona	AZ	86336	(928) 282-0118
JERKAT	3365 Deer Valley Rd	Antioch	CA	94531	(925) 706-4150
SIAM LLC.	13321 South St.	Cerritos	CA	90701	(562) 860-5635
MPLM MARAN LLC.	21431 Devonshire St.	Chatsworth	CA	91311	(818) 341-0950
M Y FOODCHAIN GROUP INC.	2661 Green River Rd	Corona	CA	92882	(951) 371-4868
HFS THREE UNCLERS INC.	3496 Camino Tassajara	Danville	CA	94506	(925) 736-0298
EFAM FOOD SERVICE LLC.	3828 N Peck Rd.	El Monte	CA	91732	(626) 442-8200
S&C FOOD INC.	500 N Sepulveda Blvd	El Segundo	CA	90245	(310) 615-0537
SUSHILAND	125 N. El Camino Real	Encinitas	CA	92024	(760) 942-5472
MAW, Win Min	2401 Waterman Drive	Fairfield	CA	94533	(707) 427-5640
SIAM LLC.	18405 Brookhurst St.	Fountain Valley	CA	92708	(714) 964-7566
LA FLOR DE MAYO	16940 Devonshire St.	Granada Hills	CA	91344	(818) 363-3173
EFAM FOOD SERVICE LLC.	1305 W Whittier Blvd.	La Habra	CA	90631	(714) 507-7602
ORGIL INC.	29211 Heather Cliff Drive	Mailbu	CA	90265	(310) 457-2401
NAING, Maung Myo	5877 Jarvis Ave.	Newark	CA	94560	(510) 713-3180
AMERICA SUN SHINE INTERNATIONAL GROUP INC.	3075 S. Archibald Bldg	Ontario	CA	91761	(909) 947-1884
JIA WEI LLC.	1435 W. Chapman Ave	Orange	CA	92868	(714) 634-2905
SOCORROSUSHI	2 CAMINO SOBRANTE	Orinda	CA	94563	(925) 254-8792
OCEAN EXPRESS ASIAN KITCHEN LLC.	1025 Alhambra Blvd	Sacramento	CA	95816	(916) 456-0852
KYAW FAMILY CORP.	3680 Crocker Ave	Sacramento	CA	95818	(916) 285-8840
AYE, Tin Nwe	5146 Stevens Creek Blvd.	San Jose	CA	95129	(408) 556-0610
MITAKASA, INC.	1050 N. Western Ave.	San Pedro	CA	90732	(310) 833-3506
MAUNG, Myint	1356 S Mary Ave	Sunnyvale	CA	94087	(408) 212-4928
MAW, Win Min	2090 Harbison Drive	Vacaville	CA	95687	(707) 452-7277
CHIN, No Thluai	7655 McLaughlin Rd	Falcon	CO	80831	(719) 495-7300
AUNG, Thura	731 South Lemay	Fort Collins	CO	80524	(970) 221-5845
AUNG, Thura	2160 W. Drake Road	Fort Collins	CO	80521	(970) 484-6048
AWI, Mang	1008 Summit Blvd	Frisco	CO	80443	(970) 668-5144
AUNG, Thura	1426 E. Harmony Road	Ft. Collins	CO	80525	(970) 223-6335
NAWL, Zion Za	681 Horizon Drive	Grand Junction	CO	81506	(970) 257-1392
CHIN, No Thluai	624 Highway 105	Monument	CO	80132	(719) 488-1187
CEU, Van Lian	5126 Community Center Dr.	USAF Academy	CO	80840	(719) 333-2025
AWI, Mang	2131 North Frontage Road	West Vail	CO	81657	(970) 476-3561
SAIZANG SUSHI INC.	26841 Tamiami Trail	Bonita Springs	FL	34134	(239) 992-0105
TUUN LEH ZUA, INC.	11600 W. Sample Rd.	Coral Springs	FL	33065	(954) 509-5288
Drawitz, Annie Mueanfan	13860 South Jog Rd	Delray Beach	FL	33446	(561) 498-2229
HTIKE, Htike Aung	7375 W. Atlantic Ave	Delray Beach	FL	33446	(561) 498-2221
MYINT, Moe Saw	20321 Summerlin Rd	Fort Myers	FL	33908	(239) 454-0145
MYINT, Moe Saw	4791 Estero Blvd	Fort Myers Beach	FL	33931	(239) 463-0378
J&C OCT FOOD INC.	5185 US Hwy 98 S	Lakeland	FL	33812	(863) 644-0386
TAWINU NU LLC.	8140 West Mcnab Rd	N Lauderdale	FL	33068	(954) 722-0599
EVERGREEN KUNG INC.	4065 Hancock Bridge Rd	North Fort Myers	FL	33903	(239) 997-0212
AUNG, Ko Ko	8725 Placida Rd	Placida	FL	33946	(941) 698-1699
AUNG, Ko Ko	1445 E Venice Ave	Venice	FL	34292	(941) 480-0779
PIANG, Sian	4075 North Haverhill Rd	West Palm Beach	FL	33417	(561) 683-0412
GRACE SUSHI LLC.	774 GA Highway 96	Bonaire	GA	31005	(478) 988-5700
MAHKAW, Gam Htoi	5435 Woodruff Farm Rd	Columbus	GA	31907	(706) 568-8820
TATSU ATLANTA INC.	5475 Bethelview Rd.	Cumming	GA	30040	(678) 455-1232
YU, Weina	2325 BETHELVIEW RD	CUMMING	GA	30040	(770) 888-1020
YU, Weina	2325 BETHELVIEW RD	CUMMING	GA	30040	(770) 888-1020
PUM, Khua	6350 Lake Oconee Pkwy	Greensboro	GA	30642	(706) 454-7140
GRACE SUSHI LLC.	5928 Zebulan Rd.	Macon	GA	31210	(478) 757-4150
HUM, Cassidy Thaw	48 Bullsboro Dr.	Newnan	GA	30263	(770) 251-4791
KHAN, Ayub	130 Peachtree East Shopping Ctr.	Peachtree City	GA	30269	(770) 486-2020
GIM, Jing	3245 Peachtree Parkway	Suwanee	GA	30024	(770) 886-5335
GIM, Jing	7780 McGinnis Ferry Rd.	Suwanee	GA	30024	(770) 622-0218
KHALIDS SUSHI LLC.	7100 W state St.	Boise	ID	83714	(208) 342-2756
KHALIDS SUSHI LLC.	640 Highway 16	Emmett	ID	83617	(208) 365-4420
ATHIN FAMILY CORP.	2203 East Oakland Avenue	Bloomington	IL	61701	(309) 663-4012
IANG, C C	1200 W Boughton Rd.	Bolingbrook	IL	60440	(630) 226-1892
J. LIANG, INC.	3400 N Western	Chicago	IL	60618	(773) 327-1204
KIM, Tae Sook	3630 N Southport	Chicago	IL	60613	(773) 327-2330
LIAN, Martin	4729 N Central Ave	Chicago	IL	60630	(773) 777-1142
LIAN, Martin	4250 N. Lincoln Ave	Chicago	IL	60618	(773) 472-6171

Zenshi Food Service Counters
List of Franchises Reacquired by Franchisor
As of End of March 31, 2025

Name	Address	City	State	Zip	Phone
LIANG, Xiao L.	1763 W. Howard	Chicago	IL	60626	(773) 274-1287
VON TAWI LLC.	3607 West Fullerton	Chicago	IL	60647	(773) 278-8355
LIANG, Xiao L.	1128 Chicago Ave	Evanston	IL	60202	(847) 869-7950
Kee, Nant S.	890 N. Western Ave.	Lake Forest	IL	60045	(847) 735-8018
J. LIANG, INC.	8900 N. Greenwood Ave	Niles	IL	60714	(847) 795-4600
Thein, Kyaw	3220 Chicago Rd.	S. Chicago Heights	IL	60411	(708) 755-7372
CANGMAH, Ram Cung Lian	199 Brookforest Ave	Shorewood	IL	60404	(815) 730-3944
TIN, John	200 N Vine St	Urbana	IL	61802	(217) 337-6016
OM, Thang K	145 South Eastwood Dr.	Woodstock	IL	60098	(815) 206-0499
CEU, Nei	3800 East Mishawaka Rd.	Elkhart	IN	46517	(574) 875-6211
LO, Va Thla	1605 Calumet Ave.	Valparaiso	IN	46383	(219) 464-8606
LIAN, Ceu Cung	1300 Anderson Crossing Dr	Lawrenceburg	KY	40342	(502) 859-0234
VILASA, FNU	301 Pond Street	Ashland	MA	01721	(508) 881-5125
USHA ENTERPRISE INC.	2040 Commonwealth Ave	Auburndale	MA	02466	(617) 965-1793
GAO, Qiong	535 Trapelo Rd.	Belmont	MA	02478	(617) 489-6540
ZOU, Mei Ya	1 Snow Road	Marshfield	MA	02050	(781) 837-5100
VILASA, FNU	230 Main St	Medfield	MA	02052	(508) 359-8713
ZAW, Myo Htet	7 Medway Road	Milford	MA	01757	(508) 422-9300
JANG, Se Won	45 Veterans Memorial Drive	North Adams	MA	01247	(413) 663-6549
ZAW, Myo Htet	62 W. Main Street	Spencer	MA	01562	(508) 885-0003
GAO, Qiong	1070 Lexington St.	Waltham	MA	02451	(781) 891-0615
ZOU, Mei Ya	610 Middle St	Weymouth	MA	02817	(781) 331-5108
THOM TE, Cin Cin Pau	18169 Towncenter Dr.	Olney	MD	20832	(301) 260-1792
WIN, Genesis	1 Chandler Dr.	Bath	ME	04530	(207) 443-9179
WIN, Genesis	147 Bath Rd. Route 1	Brunswick	ME	04011	(207) 721-9996
SANGTUALA, James	2101 Schotthill Woods Dr	Jefferson City	MO	65101	(573) 659-3600
SANGTUALA, James	2805 W Truman Blvd	Jefferson City	MO	65109	(573) 893-3111
HUALNGO, Zomawia	1801 Missouri Blvd.	Jefferson City	MO	65109	(573) 635-0753
TIN, U Tin	570 North Montana Street	Dillon	MT	59725	(406) 683-5002
VEN, Sang Bawi	611 N Montana Street	Helena	MT	59601	(406) 443-1598
SAN, Ngun Lin	117 W. Janeaux St.	Lewistown	MT	59457	(406) 538-5454
CUNG, Van Ro	940 US Highway 64 W	Apex	NC	27523	(919) 380-1422
UK, Van Thawng	1020 Bradford Plaza Way	Cary	NC	27519	(919) 460-2082
JAHAU, Lalchhanmawia	1817 Martin Luther King Jr. Pkwy.	Durham	NC	27707	(919) 489-9887
KIKKOY LLC.	3114 Raeford Rd.	Fayetteville	NC	28303	(910) 321-0114
THANG, Reuben Hau Hleih	6828 Matthews Mint Hill Road	Mint Hill	NC	28227	(704) 573-0234
LIAN, Sang Ceu	4200 Mountain Home St	Nellis AFB	NV	89191	(702) 632-5500
REH, THAE	7400 Creedmoor Rd.	Raleigh	NC	27613	(919) 848-1464
MAWL, Cer	5365 Robinhood Village Dr.	Winston-Salem	NC	27106	(336) 923-2441
PHAWT, Naw Ail	5150 Mae Anne Ave.	Reno	NV	89523	(775) 746-9000
PHAWT, Naw Ail	5150 Mae Anne Ave.	Reno	NV	89523	(775) 746-9000
TUN, Zaw Lin	2351 MAPLE ROAD	AMHERST	NY	14221	(716) 515-3200
Kyaw, Saw Zaw Hla	2101 ELMWOOD AVENUE	BUFFALO	NY	14207	(716) 515-0050
Kyaw, Saw Zaw Hla	2101 ELMWOOD AVENUE	BUFFALO	NY	14207	(716) 515-0050
SEIN, Esther Om	1740 SHERIDAN DRIVE	BUFFALO	NY	14223	(716) 874-4991
ZAR, Htat Yar	71 NELSON STREET	CAZENOVIA	NY	13035	(315) 655-4565
TUN, Zaw Lin	3865 UNION ROAD	CHEEKTOWAGA	NY	14225	(716) 684-5927
TIN HLA, Kyu Kyu Mar	6914 ERIE ROAD	Derby	NY	14047	(716) 947-4019
TIN HLA, Kyu Kyu Mar	3955 VINEYARD DRIVE	Dunkirk	NY	14048	(716) 366-2050
ZAR, Htat Yar	350 Towne Dr.	Fayetteville	NY	13066	(315) 637-8039
LIAN, Mang	2140 Grand Island Blvd	Grand Island	NY	14072	(716) 775-1138
TUN, Han	3507 MT. READ BLVD	Greece	NY	14616	(585) 663-4400
ZAR, Htat Yar	119 WEST SENECA STREET	MANLIUS	NY	13104	(315) 682-7261
LIAN, Mang	301 Meadow Dr	North Tonawanda	NY	14120	(716) 743-4350
TUN, Han	1601 PENFIELD ROAD	Rochester	NY	14625	(585) 264-0820
ZAR, Htat Yar	620 NOTTINGHAM ROAD	SYRACUSE	NY	13224	(315) 446-1652
Win, Pwint Su Wai	355 ORCHARD PARK RD.	West Seneca	NY	14224	(716) 517-3000
SEIN, Esther Om	5274 Main Street	Williamsville	NY	14221	(716) 632-7411
HAN KHO AUNG SUSHI LLC.	1990 14th Ave. SE	Albany	OR	97322	(541) 812-2380
BOXER	6055 SW 185th Ave	Aloha	OR	97078	(503) 642-7059
ORAWAN SUSHI LLC.	1800 NE 3rd Street	Bend	OR	97701	(541) 382-3661
PI, Hon	138 W. Ellendale	Dallas	OR	97338	(503) 831-6000
TAKNAN FAMILY SUSHI LLC.	3333 W 11th Ave.	Eugene	OR	97402	(541) 484-4200
AUNG, Zaw Min	4701 Highway 101	Florence	OR	97439	(541) 902-7300
BAMA SUSHI, LLC.	401 A Ave.	Lake Oswego	OR	97034	(503) 675-4480
KU, Say	4101 Logan Road	Lincoln City	OR	97367	(541) 994-8667
YOSHI SUSHI LLC.	1705 South Highway 97	Redmond	OR	97756	(541) 504-4160
KHE, Shwe	30300 SW Boones Ferry Road	Wilsonville	OR	97070	(503) 570-3509
KHAI, Hau Sian	1985 Folly Rd.	Charleston	SC	29412	(843) 762-6255
BIK, Bawi Thiang	1435 Ben Sawyer Blvd.	Mt. Pleasant	SC	29464	(843) 856-3018

Zenshi Food Service Counters
List of Franchises Reacquired by Franchisor
As of End of March 31, 2025

Name	Address	City	State	Zip	Phone
KHAI, Pau	781 Main St.	North Myrtle Beach	SC	29582	(843) 249-9950
Khun, Hniang	BUILDING 407 WAKE BOULEVARD	Parris Island	SC	29905	(843) 228-2383
CIN, Thang Khan	1931 Long Hollow Pike	Gallatin	TN	37066	(615) 230-7647
TLUANGA, Benjamin	5928 Hixson Pike Ste 112	Hixson	TN	37343	(423) 847-8461
THA, Van Cer	1095 Judge Ely Blvd	Abilene	TX	79601	(325) 677-8527
THA, Van Cer	3301 S. 14th St.	Abilene	TX	79605	(325) 698-9391
SANG, WILLIAM	302 South Park Blvd	Grapevine	TX	76051	(817) 481-5669
MUVANLAI SUSHI INC.	12815 Indiana Ave	Lubbock	TX	79423	(806) 776-8900
LABYA, Hkawn N	10801 D. STREET BLDG 337	NAS CORPUS CHRISTI	TX	78419	(361) 961-2545
THAWNG, Lian Biak	25401 East Gate Marketplace Plaza	Chantilly	VA	20152	(703) 722-2126
ONG FAMILY ENTERPRISE INC.	545 Radford Lane	Charlottesville	VA	22903	(434) 823-1184
SOE, Than Lwin	14020 Main St. N.E.	DUVALL	WA	98019	(425) 844-1188
THANG, Richard Tuan Kip	510 Grant Rd	East Wenatchee	WA	98802	(509) 884-0707
THANGTHAT, Jedidiah B	5502 Point Fosdic Dr. NW	Gig Harbor	WA	98335	(503) 797-5750
HKUM, Seng	460 SW Mt Si Blvd	North Bend	WA	98045	(425) 831-2122
PUJI, Lal Nun	4300 NE 4th Street	Renton	WA	98059	(425) 226-7666
KO, Htway Ko	516 1st. Ave. W.	Seattle	WA	98119	(206) 494-1685
NA, Elve	2507 W Wellesley	Spokane	WA	99205	(509) 327-4593
THANG, Richard Tuan Kip	501 North Miller St.	Wenatchee	WA	98801	(509) 663-5336

If you buy this franchise, your contact information may be disclosed to other buyers when you leave the franchise system.

Zenshi Food Service Counters
Ceased Operations
As of March 31, 2025

Name	Address	City	State	Zip	Phone
LIU, Li	15120 Sunset Blvd.	Pacific Palisades	CA	90272	(310) 454-3001
MAY, Kyu Kyu	1335 Webster Street	San Francisco	CA	94115	(415) 921-4557
TUN, Soe	774 Admiral Callahan Ln	Vallejo	CA	94590	(707) 554-8035
YK SUSHI INC.	906 East Lake Ave	Watsonville	CA	95076	(831) 726-0420
NAING, Shwe Bhone Myat	2986 Berlin Turnpike	Newington	CT	06111	(860) 665-8342
WIN, Thein Htay	6030 14th St. W	Bradenton	FL	34207	(941) 756-3455
SIAM, Siang Nei	1295 Missouri Ave.	Clearwater	FL	33756	(727) 442-8606
HUANG, Shuling	9964 Old Baymeadows Rd.	Jacksonville	FL	32256	(904) 641-2435
TIAL, Monica	4730 S. Florida Ave	Lakeland	FL	33813	(863) 646-8537
SIT, Hmun Hmun	2435 S. Hiawasse Rd.	Orlando	FL	32835	(407) 294-7104
LIAN, Ni	4601 9th St. N.	Naples	FL	34103	(239) 649-6400
ZAM, Hram Nei	160 Mariner	Spring Hill	FL	34609	(352) 688-0977
OO, Khin Nwe	1033 A1A Beach Blvd.	St. Augustine	FL	32084	(904) 461-0231
KHAI, Mang Khan	3900 66th Street North	St. Petersburg	FL	33709	(727) 343-2879
KHAM, Paul Go Suan	3300 Cobb Parkway	Atlanta	GA	30339	(770) 952-0778
MUNG, Thang Gin	2000 Mirror Lake Blvd	Villa Rica	GA	30180	(678) 840-8778
CHEN, Min	590 Kailua Road	Honolulu	HI	96734	(808) 266-4004
LIAN, Lal Pek	10700 Ustick Road	Boise	ID	83713	(208) 322-7744
LIAN, Lal Pek	3301 West Cherry Ave	Meridian	ID	83642	(208) 884-5471
NAU, Osman	4800 N University	Peoria	IL	61614	(309) 690-3242
NAU, Osman	10405 N Centerway Dr.	Peoria	IL	61615	(309) 621-7340
MANG TEI, Amos	7272 Fishers Crossing Drive	Fishers	IN	46038	(317) 579-0201
MARAN, Raymond Khun Aung	3446 Drusilla Lane	Baton Rouge	LA	70809	(225) 776-4800
JANGMAW, Seng Hkawn	14640 Village Market Street	Baton Rouge	LA	70817	(225) 448-0050
KI, Mang Cer	5909 Florida BLVD.	Baton Rouge	LA	70806	(225) 251-1200
BAWK, Htoi	7580 Bluebonnet Blvd	Baton Rouge	LA	70810	(225) 251-1010
RAHKAWI, Aung Dee	600 Arlington Creek Centre Blvd	Baton Rouge	LA	70820	(225) 448-0271
HEI, Thang	10130 Crossing Way	Denham Springs	LA	70726	(225) 435-7070
THLENG, Biak	209 S. Airline Highway	Gonzales	LA	70737	(225) 644-6686
THAWNG, Lian	14635 Airline Highway	Gonzales	LA	70737	(225) 673-4255
HEI, Thang	2704 W. Thomas Street	Hammond	LA	70401	(985) 340-4924
LAL, Ram Hu	2233 Martin Luther King Blvd.	Houma	LA	70360	(985) 293-2110
LING, MOSES	1410 St. Charles Street	Houma	LA	70360	(985) 580-2525
SUNG, Amy	6136 Johnston Street	Lafayette	LA	70503	(337) 889-0040
BIK, Ngun Ceu	601 Bertrand Drive	LaFayette	LA	70506	(337) 889-0045
CEU, John San Cung	1810 Camellia Blvd.	Lafayette	LA	70508	(337) 889-0015
THA, Ceu	1351 Sam Houston Jones Parkway	Lake Charles	LA	70611	(337) 502-0120
SENG, Aung	6403 HIGHWAY 90 EAST	Morgan City	LA	70380	(985) 384-4477
ZING, Dawt Len	900 E. Admiral Doyle Drive	New Iberia	LA	70560	(337) 551-5002
LI, Seng	58440 Belleview Highway	Plaquemine	LA	70764	(225) 685-0422
THAWNG, Lian	260 Highway 70 Spur	Plattenville	LA	70393	(985) 369-3200
BIK, Iang Ci	145 Berryland Shopping Center	Ponchatoula	LA	70454	(985) 401-0010
San, Nang	40017 Highway 42	Prairieville	LA	70769	(225) 622-4041
THAWNG, Lian	800 Carlyss Boulevard	Sulphur	LA	70665	(337) 502-0110
LIAN, Nun	204 North Canal Blvd	Thibodaux	LA	70301	(985) 446-3427
MANG, Fung	1030 S. Acadia Rd	Thibodaux	LA	70301	(985) 387-6025
WAI, Ted	2900 E. Milton Ave	Youngsville	LA	70592	(337) 362-2814
SUNG, Ngun Tha	2300 Church Street	Zachary	LA	70791	(225) 658-2784
SENG, Htoi	10233 Manchester Rd.	Kirkwood	MO	63122	(314) 965-7310
AWI, Lian Cung	3863 State Route 31	Liverpool	NY	13090	(315) 622-6008
CHIN, ZING BOR	162 Seven Farms Rd	Daniel Island	SC	29492	(843) 388-1180
LIAN, Kham Zam	4560 Harding Rd.	Nashville	TN	37205	(615) 269-5649
AUNG, Khant Hmue	600 N. Glebe Rd	Arlington	VA	22203	(703) 526-9100
MAN LAL, Zen Lam	13719 SE Mill Plain Blvd	Vancouver	WA	98684	(360) 891-4245

If you buy this franchise, your contact information may be disclosed to other buyers when you leave the franchise system.

AFC Food Service Counters

Franchise List

As of March 31, 2025

Franchisee Name	Address	City	State	Zip	Phone
THONKRATOK, Somchai	3200 Providence Dr.	Anchorage	AK	99508	(907) 562-2211
OO, Myo Thein	1802 6th Avenue	Birmingham	AL	35249	(205) 996-2719
YOO, Jun Young	2003 US Highway 31 N	Deatsville	AL	36022	(334) 361-2425
THANG, John Hlawn Nuam	1221 Almon Street	Heflin	AL	36264	(256) 463-2310
KHAN, Pau Za	5 Mobile Infirmary Circle	Mobile	AL	36607	(251) 435-2400
CIN ZAH, Tuang Bawi Chin Par	1000 Jemison Lane	Mountain Brook	AL	35223	(205) 802-9189
THANG, John Hlawn Nuam	115 E Ladiga St	Piedmont	AL	36272	(256) 447-8006
THANG, John Hlawn Nuam	1115 Main St	Roanoke	AL	36274	(334) 863-6712
THANG, John Hlawn Nuam	190 Village Ln	Wedowee	AL	36278	(256) 357-4914
MARIP, Seng Lum	9601 Baptist Way	Little Rock	AR	72205	(501) 202-2200
PAU, Zam Suan	21064 W. Main St.	Buckeye	AZ	85396	(623) 388-6000
MYINT, Khin Maung	650 W Finnie Flat Rd	Camp Verde	AZ	86322	(928) 567-4585
PEI, Sin	36889 Tom Darlington	Carefree	AZ	85377	(480) 488-1797
CHIT, Ye Naing	1955 W Fry Road	Chandler	AZ	85224	(480) 728-3000
SAW, San Maung Win	1200 N. Beaver Street	Flagstaff	AZ	86001	(928) 779-3366
THAWNG, Bawi Nun	2700 S. Woodlands Village Blvd.	Flagstaff	AZ	86001	(928) 774-3882
WIN, Kyaw Naing	99 S. Higley Rd	Gilbert	AZ	85296	(480) 926-5220
KHAING, Aung Kyaw	5555 W. Thunderbird Rd	Glendale	AZ	85306	(602) 865-5555
AWI, Om	5311 S Superstition Mtn. Drive	Gold Canyon	AZ	85118	(480) 474-9401
THEIN, Shwe	3269 Maricopa Ave	Lake Havasu City	AZ	86406	(928) 854-9550
MAWI, Biak	5115 N. Dysart Road	Litchfield Park	AZ	85340	(623) 547-4580
MYINT, Wah	21044 N. John Wayne Pkwy	Maricopa	AZ	85239	(520) 836-4400
CHO, Jeongae	1133 N. Ellsworth Road	Mesa	AZ	85207	(480) 357-3300
MAUNG, Win Htwe	2864 N Power Road	Mesa	AZ	85215	(480) 830-7900
CHO, Jeongae	1122 North Higley Road	Mesa	AZ	85205	(480) 396-8098
WIN, Kyaw Naing	9925 E. Baseline Rd	Mesa	AZ	85209	(480) 354-2798
LIAN, Pau Suan	9201 W Thomas Rd	Phoenix	AZ	85037	(623) 327-4000
SOE, Yee Yee	731 E. Union Hills Dr	Phoenix	AZ	85024	(602) 652-9520
PHAY, Tun	5521 N 7th St	Phoenix	AZ	85014	(602) 222-1820
PI, Piang	1111 E. McDowell Rd	Phoenix	AZ	85006	(602) 839-2000
TUN, Myo	1919 E Thomas Road	Phoenix	AZ	85016	(602) 933-1000
Weerasa, Sayun	350 W. Thomas Road	Phoenix	AZ	85013	(602) 406-3000
OO, Khin Thida	9020 W. Thomas Road	Phoenix	AZ	85037	(623) 872-6200
SOE, Yee Yee	10631 N. 32nd Street	Phoenix	AZ	85028	(602) 996-1040
MAUNG, Win Htwe	23760 S. Power Rd	Queen Creek	AZ	85142	(480) 279-5700
Saw Ju, Saw Min	10111 E. Bell Road	Scottsdale	AZ	85260	(480) 563-0624
Saw Ju, Saw Min	8423 E. McDonald Drive	Scottsdale	AZ	85250	(480) 948-8110
SOE, Yin Min	8035 E. Indian School Road	Scottsdale	AZ	85251	(480) 946-6821
PENG, David Lian	100 Verde Valley School Road	Sedona	AZ	86351	(928) 284-2202
LAL, Paul Thawng Khau	14502 W. Meeker Blvd	Sun City	AZ	85375	(623) 524-4000
PAU, Zam Suan	10401 W. Thunderbird Blvd	Sun City	AZ	85351	(623) 524-4000
MAUNG, Win Htwe	10325 E. Riggs Rd	Sun Lakes	AZ	85248	(480) 802-7180
PIANG, Pau Sian	15310 N. Oracle Road	Tucson	AZ	85739	(520) 575-7300
LIAN, Go Khan	6900 E Sunrise Dr	Tucson	AZ	85750	(520) 299-0633
THI, Myat Kay	1625 N. Campbell Ave	Tucson	AZ	85724	(520) 694-8888
WIN, Samuel	8360 N Thornydale Rd	Tucson	AZ	85741	(520) 744-4488
LIAN, Go Khan	5301 E Grant Road	Tucson	AZ	85712	(520) 324-5220
LEE, Molly	2531 Blanding Ave.	Alameda	CA	94501	(510) 814-8800
FAN, Kevin	2531 Blanding Ave	Alameda	CA	94501	(510) 814-8800
WINT, Kyaw Thu Zaw	7901 Walerga Rd.	Antelope	CA	95843	(916) 725-0333
KHAING, Tun Aung	7901 Walerga Rd.	Antelope	CA	95843	(916) 725-0333
AYE, Win	2222 Grass Valley Hwy	Auburn	CA	95603	(530) 889-8626
SHAY, Maung Bu	13384 Lincoln Way,	Auburn	CA	95603	(530) 885-0669
BULATETSKYI, Yurii	2222 Grass Valley Hwy	Auburn	CA	95603	(530) 889-8626
MARAN, Zau Seng	890 Southampton Rd.	Benicia	CA	94510	(707) 746-1203
TOO, Naw M	1602 W. Campbell Ave.	Campbell	CA	95008	(408) 379-6650
CHOI, Chang Won	809 Bay Ave.	Capitola	CA	95010	(831) 476-5600
NWE, Tin Mya	5159 Fair Oaks Blvd	Carmichael	CA	95608	(916) 483-9033
ZHANG, Zhilang	4005 Manzanita Ave.	Carmichael	CA	95608	(916) 483-2691
HLAING, Zaw Zaw	211 West East Ave.	Chico	CA	95926	(530) 899-3300
BUL, Kimoanh Thi	4100 Black Hawk Circle	Danville	CA	94506	(925) 648-5800
HTAY, May Than	3360 San Pablo Dam Road	EL SOBRANTE	CA	94803	(510) 222-5935
CHANG, Chia Lin	4900 Elk Grove Blvd	Elk Grove	CA	95758	(916) 683-0700
XIE, Yuhong	4900 Elk Grove Blvd	Elk Grove	CA	95757	(916) 683-0700
VANG, Alexander B. Chue	5100 Laguna Blvd.	Elk Grove	CA	95758	(916) 684-7000
HUANG, Weixiang	8425 Elk Grove-Florin Rd.	Elk Grove	CA	95624	(916) 681-5775
CHAW, Akar	9435 Elk Grove Blvd.	Elk Grove	CA	95624	(916) 714-6996
MYO, Mon Nandar	5100 Laguna Blvd.	Elk Grove	CA	95758	(916) 684-7000
AUNG, Mung Myat	39200 Paseo Padre Parkway,	Fremont	CA	94538	(510) 791-0233
AUNG, Saw M.	10430 Twin Cities Rd	Galt	CA	95632	(209) 745-4668
ZENG, Shuhua	10430 Twin Cities Rd.	Galt	CA	95632	(209) 745-4668
JUNG, Gordon	777 First St.	Gilroy	CA	95020	(408) 847-4857

AFC Food Service Counters

Franchise List

As of March 31, 2025

Franchisee Name	Address	City	State	Zip	Phone
ENKHBAATAR, Sarangerel	6845 Douglas Blvd.	Granite Bay	CA	95746	(916) 791-8000
SWE, Mon Mon	692 Freeman Lane	Grass Valley	CA	95949	(530) 272-1958
OO, Ne Tun	1700 Airline Hwy	Hollister	CA	95023	(831) 637-7447
HTUN, Kay Thi	39 Lincoln Blvd	Lincoln	CA	95648	(916) 408-5775
WINT, Kyaw Thu Zaw	39 Lincoln Blvd	Lincoln	CA	95648	(916) 408-5775
HTIN LIN, Ni Ni	919 East Stanley Blvd	Livermore	CA	94550	(925) 443-9500
TUN, Tun	6119 Horseshoe Bar Road	Loomis	CA	95650	(916) 652-5737
THAN, Naing	342 First Street	Los Altos	CA	94022	(650) 948-4425
HONG, James Kee	1111 S Figueroa Street	Los Angeles	CA	90015	(213) 742-7825
MIN, Tun	24197 Summit Road	Los Gatos	CA	95033	(408) 353-2186
AYE, Nay Myint	1280 Lathrop Rd.	Manteca	CA	95336	(209) 825-0242
WIN, Nyo Nyo	520 Center Ave.	Martinez	CA	94553	(925) 370-9400
THAN, Naing	1010 University Drive	Menlo Park	CA	94025	(650) 324-7700
THANTINT, Maung	3550 North G Street,	Merced	CA	95340	(209) 722-3689
THU, Nay Myo	21088 Calistoga Rd.	Middletown	CA	95461	(707) 987-3020
AUNG THU, Su Myat	3020 Floyd Avenue	Modesto	CA	95355	(209) 551-2050
TUN, Aung Kyaw	451 Vineyard Town Center	Morgan Hill	CA	95037	(408) 779-8485
HTWE, Ni Ni	1250 Grant Road	Mountain View	CA	94040	(650) 390-9222
HTOO, Saw Sar	611 Trancas Street,	Napa	CA	94558	(707) 224-8583
MARAN, Zau Seng	217 Soscol Ave.	Napa	CA	94559	(707) 224-7897
Tun, Aik	1945 N Street,	Newman	CA	95360	(209) 862-1002
AUNG, Maung Aye Tun	40041 Highway 49	Oakhurst	CA	93644	(559) 683-8300
KHINE, Aung	101 The City Dr.	Orange	CA	92868	(714) 319-2896
LEE, Tong Neng	2325 Meyers Street.	Oroville	CA	95966	(530) 533-2515
SAN, Tin	5420 Sunol Blvd	Pleasanton	CA	94566	(925) 846-4471
PAING, Kaung Khant	725 S. Main st.	Red Bluff	CA	96080	(530) 527-6902
MIN, Thet	201 Lake Blvd.	Redding	CA	96003	(530) 246-3508
LAM, Hae Hyoung Joo	270 Redwood Shore Pkwy	Redwood city	CA	94065	(650) 654-2106
LAH PAI, Roilum	2341 Sunset Blvd	Rocklin	CA	95765	(916) 632-0180
Park, Heesun	100 Raley's Town Center	Rohnert Park	CA	94928	(707) 585-3222
TUN, Pyae Phyoo	1915 Douglas Blvd	Roseville	CA	95661	(916) 781-7845
HUANG, Shijuan	1039 Sunrise Ave.	Roseville	CA	95661	(916) 786-6101
ENKHBAATAR, Sarangerel	4008 Foothills Blvd.	Roseville	CA	95747	(916) 783-1173
LIAN, John Khawi	4650 Natomas Blvd.	Sacramento	CA	95835	(916) 419-6633
LWIN, Yuki S	1540 West El Camino	Sacramento	CA	95833	(916) 920-2493
LWIN, Yuki S	3250 Arena Blvd.	Sacramento	CA	95834	(916) 419-8844
CHEN, Siyin	1540 West El Camino	Sacramento	CA	95833	(916) 920-2493
WU, Ming Feng	1301 Florin Rd.	Sacramento	CA	95831	(916) 421-6766
YI, Lae Lae	4320 Arden Way	Sacramento	CA	95864	(916) 972-0555
CHANG, Chia Lin	7465 Rush River Dr.	Sacramento	CA	95831	(916) 399-9091
LAH PAI, Roilum	3518 Marconi Ave.	Sacramento	CA	95821	(916) 972-7177
TWAY, Tin Tin	4690 Freeport Blvd	Sacramento	CA	95822	(916) 451-0126
HTET, Kyaw Min	1301 Florin rd.	Sacramento	CA	95831	(916) 421-6766
LI, Yong Huo	7465 Rush River Dr.	Sacramento	CA	95831	(916) 399-9091
MIN, Min	1320 South Main St.	Salinas	CA	93901	(831) 758-8481
LEE, Helen	2111 Harrison Street	San Francisco	CA	94110	(415) 431-9300
LEE, Helen	1101 4th Street	San Francisco	CA	94158	(415) 943-8464
LIN, Phillip	1530 Haight Street	San Francisco	CA	94117	(415) 255-0643
LEE, Helen	3701 Noriega Street	San Francisco	CA	94122	(415) 564-0370
WIN, Aung Soe	1421 Foxworthy	San Jose	CA	95118	(408) 264-0103
LIN, San	1970 Naglee Ave.	San Jose	CA	95126	(408) 294-9151
AUNG, Aye Thiri Myo	6061 Snell Ave.,	San Jose	CA	95123	(408) 225-0546
LEE, Amanda Raelene	3555 Monroe Street	Santa Clara	CA	95051	(408) 557-0115
HTAY, Khin Maung	1465 Town and Country Dr.	Santa Rosa	CA	95404	(707) 546-3663
KIM, Younghee	222 Mt. Herman Rd.	Scotts Valley	CA	95066	(831) 438-1610
MYINT, Jennie Myo	550 Gravenstein Hwy North	Sebastopol	CA	95472	(707) 823-1418
WUN, Min Chan	4255 Morada Lane	Stockton	CA	95212	(209) 956-9300
MYINT, Cho Cho	270 Sunset Ave.	Suisun City	CA	94585	(707) 426-1023
Htoo, Tint Lwin	2550 South Tracy Blvd	Tracy	CA	95376	(209) 830-7700
KHAT, Tin	2900 Geer Rd.	Turlock	CA	95382	(209) 667-5253
AUNG, Myint	1315 North State Street	Ukiah	CA	95482	(707) 468-5178
SAETEURN, Kao Seng	3061 Alamo Dr.	Vacaville	CA	95687	(707) 446-8707
KWONG, Mike Mo Yun	3061 Alamo Drive	Vacaville	CA	95687	(707) 446-8707
ZHENG, XiaoMei	1912 Main St.	Watsonville	CA	95076	(831) 728-9555
MON, Wut Yee	500 West Capitol Ave	West Sacramento	CA	95605	(800) 925-9989
MON, Wut Yee	1601 West Capitol Ave	West Sacramento	CA	95691	(916) 372-3000
PARSONS, James Michael	1885 East Gibson Rd.	Woodland	CA	95776	(530) 668-4422
KYI, Mya	1842 Fort Jones	Yreka	CA	96097	(530) 842-4307
HTOO, Kyaw Kaw	700 W. Onstott Frontage Road	Yuba City	CA	95991	(530) 673-5931
AUNG, Ma Su Su	1286 Stabler Lane	Yuba City	CA	95993	(530) 755-3991
LIAN, Van	4747 Arapahoe Ave.	Boulder	CO	80303	(303) 415-7000
MYINT, Thein Htay	801 16th Street	Denver	CO	80202	(303) 571-5314

AFC Food Service Counters

Franchise List

As of March 31, 2025

Franchisee Name	Address	City	State	Zip	Phone
WIN, SAN DA	121 Farmington Ave	Bristol	CT	6010	(860) 582-2876
CHEZIN, Lobsang	1220 Storrs Road	Mansfield	CT	6268	(860) 553-6555
NAING, Moe Mu Yar	855 Washington St	Middletown	CT	6457	(860) 740-7700
NAING, Aung Myo	20 York Street	New Haven	CT	6511	(617) 980-0284
NAING, Aung Myo	1450 Chapel St	New Haven	CT	6511	(203) 789-3000
VIMALA, NFN	300 Oxford Road	Oxford	CT	6478	(203) 463-7990
NAING, Shwe Bhone Myat	410 Queen Street	Southington	CT	6489	(860) 621-2128
GOKUL, FNU	990 Torrington Street	Torrington	CT	6790	(860) 496-5051
ARIYA, No Name Given	1076 Post Road East	Westport	CT	6880	(203) 349-4138
NAING, Moe Mu Yar	675 Poquonock Ave	Windsor	CT	6095	(860) 687-1411
HTUT, Maung Than	700 19th Street NW	Washington	DC	20431	(202) 623-7000
HTUT, Maung Than	1900 Pennsylvania Ave NW	Washington	DC	20421	(202) 623-7000
AUNG, Tun Naing	1201 First St. NE	Washington	DC	20002	(202) 589-0351
LIAN, Saw	1631 Kalorama Rd NW	Washington	DC	20009	(202) 986-1415
VUM, Tual	111 Michigan Ave NW 300	Washington	DC	20010	(202) 476-5000
MANG, Lai San	1790 Ash St SE	Washington DC	DC	20032	(202) 282-8010
PAUZO, Pasian	4800 First Coast Hwy	Fernandina Beach	FL	32034	(904) 491-1213
NAING, Soe	1600 S. Andrews Ave.	Fort Lauderdale	FL	33316	(954) 355-5661
HLATHAUNG, Amy	4747 S Florida Ave	Lakeland	FL	33813	(863) 680-5229
NYUNT, Peter	1611 NW 12th Avenue	Miami	FL	33136	(305) 585-8159
NYUNT, Peter	1611 NW 12th Avenue, DTC 143	Miami	FL	33136	(305) 525-8159
KHUP, Thang En	1414 Kuhl Ave.	Orlando	FL	32806	(321) 841-3040
SHIN, Michael Myint	601 E. Rollins Street	Orlando	FL	32803	(407) 303-1793
KHUP, Thang En	83 West Miller Street	Orlando	FL	32806	(321) 841-1614
MYAING, Yin Yin	201 E Sample Rd	Pompano Beach	FL	33064	(954) 941-8300
LEONG, Richard Kyi Sein	401 Kennedy Street	Tampa	FL	33606	(813) 253-3333
KHIN, Henry	13000 Bruce B Downs Blvd	Tampa	FL	33612	(813) 972-2000
YEE, Khine Su	2950 Cleveland Clinic Blvd	Weston	FL	33331	(954) 659-5000
KHUP, Suan Khan	1021 N Loop Road	Atlanta	GA	30354	(404) 714-0543
HNEM, Van Bawi	600 Saint Simons Island	St. Simons	GA	31522	(912) 638-8100
AUNG, Htin	4416 Waiialo Road	Eleele	HI	96705	(806) 354-8788
KHURASRI, Narisa	5-5172 Kuhio Hwy	Hanalei	HI	96714	(808) 826-6652
HUANG, Gui Fang	3221 Waiialae Avenue	Honolulu	HI	96816	(808) 733-5050
TAN, Keong Laurel Ping Sie	1301 Punch Bowl St.	Honolulu	HI	96813	(808) 538-9011
CHEN, Min	45-934 Kamehameha Highway	Kaneohe	HI	96744	(808) 233-4622
KHURASRI, Narisa	1105 F Kuhio Hwy	Kapa'a	HI	96746	(808) 822-4971
LAHPAI, John Z.	1310 South Kihei Rd	Kihei	HI	96753	(808) 442-4750
AUNG, Htin	5516 Koloa Road	Koloa	HI	96756	(808) 742-1614
LAHPAI, John Z.	3350 Lower Honoapiilani Rd.	Lahaina	HI	96761	(808) 442-4700
AUNG, Htin	32600 Kaunualii Hwy	Lihue	HI	96766	(808) 245-7777
Du, Zen	94-766 Farrington Hwy.	Waipahu	HI	96797	(808) 671-0502
SANGA, Lalnghak	2002 Woodland Avenue	Des Moines	IA	50312	(515) 243-1754
HTUN, Tutu	720 E. Park Blvd.	Boise	ID	83712	(208) 381-2222
CING, Ciin Ngaih	757 North Michigan Ave	Chicago	IL	60611	(312) 664-8686
OU, Zhuangxiao	225 E. Chicago Ave	Chicago	IL	60611	(312) 227-4000
CING, Ciin Ngaih	151 North State Street	Chicago	IL	60601	(312) 863-4249
CING, Ciin Ngaih	410 North Michigan Ave	Chicago	IL	60611	(312) 321-0951
Khual, Cin Za	2400 N Harlem Ave.	Elmwood Park	IL	60707	(708) 453-0155
LIAN, Sian Khaw	3115 111th Street	Naperville	IL	60564	(630) 579-3300
KHUAL, Thang	622 North Randall Rd.	South Elgin	IL	60177	(847) 289-0600
ZATHANG, Carson Lenza	Lilly Corporate Center DC 1805	Indianapolis	IN	46285	(317) 277-7183
TE, Lal	800 Rose Street	Lexington	KY	40536	(859) 323-5825
PAR, Lily	1201 Pleasant Valley Rd.	Owensboro	KY	42303	(270) 417-2000
SUNG, Amy	5525 Cameron Street	Scott	LA	70583	(337) 232-9877
REH, Mee	248 Great Road	Acton	MA	1720	(978) 635-9893
SHERPA, Ngima	106 Saint Stephen St.	Boston	MA	2115	(617) 373-2530
SHERPA, Doma	24 School Street	Boston	MA	2108	(617) 372-8156
TUN, Tin	560 Main Street	Gardner	MA	1440	(978) 730-1040
HTITE, Saw Wei Lin	300 Stockbridge Road	Great Barrington	MA	1230	(413) 528-8415
LWIN, Su Sandar	167 West Main Street	Hopkinton	MA	1748	(508) 625-3263
HTITE, Saw Wei Lin	495 Pittsfield Road	Lenox	MA	1240	(413) 443-5449
KHAING, Lai Lai	145 Lincoln Road	Lincoln	MA	1773	(781) 259-0144
KHAING, Lai Lai	236 Great Rd.	Littleton	MA	1460	(978) 486-8986
LWIN, Su Sandar	240 East Main Street	Marlborough	MA	1752	(508) 480-0109
GUO, Zheng Hua	555 Hubbard Ave	Pittsfield	MA	1201	(413) 442-7696
WANGMO, Tsering	731 Boston Turnpike	Shrewsbury	MA	1545	(508) 791-7142
CHEN, Shi Ping	171 Worcester-Providence Turnpike	Sutton	MA	1590	(508) 865-5168
CHEN, Shi Ping	2 Worcester Road	Webster	MA	1570	(508) 943-7232
PHUNTSOK, Dhamchoe	72 Pullman Street	Worcester	MA	1606	(508) 854-8474
WANGMO, Tsering	221-223 Park Ave	Worcester	MA	1609	(508) 798-5178
CHEN, Shi Ping	564 South West Cutoff	Worcester	MA	1610	(508) 752-3737
SANG, Van Run	3779 Boston St.	Baltimore	MD	21224	(410) 522-0270

AFC Food Service Counters

Franchise List

As of March 31, 2025

Franchisee Name	Address	City	State	Zip	Phone
THAN, Hrang	1801 Whetstone Way	Baltimore	MD	21230	(410) 528-8484
ZAN, Kyawt Kyawt	10 Center Drive	Bethesda	MD	20892	(301) 496-4000
LIAN, Bawi Tin	4805 Battery Lane	Bethesda	MD	20814	(240) 630-8635
TIAL, Elena Hlawn	44900 St Andrews Church Rd.	California	MD	20619	(301) 737-2393
CHO, Ham Liang	6906 Cooper Ave	Fort Meade	MD	20755	(301) 225-8100
CHEN, Hai Yan	323 Copley Place	Gaithersburg	MD	20878	(301) 963-7904
THANT, Orion	2657G Annapolis Rd.	Hanover	MD	21076	(410) 551-8700
THANG, Hniang Hnem	11100 Johns Hopkins Rd.	Laurel	MD	20723	(240) 228-5000
TUN, Khin Thida	12525 Park Potomac Ave	Potomac	MD	20854	(301) 294-5329
LIANI, Zo Siam	11845 Old Georgetown	Rockville	MD	20852	(301) 468-3029
NWAY, Ma	9655 Colorado Lane N	Brooklyn Park	MN	55445	(763) 315-6767
GYATSO, Sherap	8600 North 114th Avenue	Champlin	MN	55316	(763) 427-2714
WANGDUE, Tsering	7900 Market Blvd	Chanhausen	MN	55317	(952) 934-1010
NWAY, Ma	12900 Riverdale Dr.	Coon Rapids	MN	55448	(763) 421-4252
KHAING, Myat Thwe Thwe	615 West Central Entrance	Duluth	MN	55811	2187270272
SUNG, Nawn	1661 N Coley Rd.	Tupelo	MS	38801	(662) 269-3369
TUANG, Gin Lam	Atrium Health Mercy Hospital	Charlotte,	NC	28207	(704) 304-5000
AUNG, Hnin San Di	2810 Teachey Place	Apex	NC	27502	(984) 319-1915
BAWI, Lian Cung	136 Merrimon Ave	Asheville	NC	28801	(828) 255-1817
THIN, Mya	2727 South Church Rd.	Burlington	NC	27215	(336) 585-1444
AYE, Naw A	2080 Kildaire Farm Rd.	Cary	NC	27518	(919) 233-9483
Tha, Si Le	11135 Golf Links Dr.	Charlotte	NC	28277	(704) 303-8601
SUIZASIN, Veronica	7852 Rea Rd.	Charlotte	NC	28277	(704) 341-7657
PAR, Biak C	4701 Smith Farm Rd	Charlotte	NC	28216	(704) 949-2220
CIN, Lang Kai	2717 South Blvd	Charlotte	NC	28209	(704) 527-1018
TUANG, Gin Lam	1000 Blythe Blvd	Charlotte	NC	28203	(704) 355-2000
THANG, Kio Cin	6701 Morrison Blvd.	Charlotte	NC	28211	(704) 364-1245
THAWNG, Biak	15007 John J Delaney Dr.	Charlotte	NC	28277	(704) 716-2000
HTOO, Kay Kaw	67 Flowers Crossroads Way	Clayton	NC	27527	(919) 359-9154
KERO, Bei	19815 N. Cove Rd.	Cornelius	NC	28031	(704) 895-5020
OO, Thet	2800 Raeford Rd.	Fayetteville	NC	28303	(910) 484-6000
NAING, Soe	3330 W. Friendly Ave.	Greensboro	NC	27410	(336) 297-1361
SOE, Kyaw	2100 Stantonsburg Road	Greenville	NC	27835	(252) 847-4405
CUNG, Zo Duh	265 Eastchester Dr.	High Point	NC	27262	(336) 869-6317
SAY, Lah	4055 Curtis Rd	Jacksonville	NC	28545	(910) 449-6395
HUM, Roy Van Bawi	445 Leslie Campbell Ave	Lillington	NC	27546	(910) 893-1536
VUNG, Don Lam	5920 Weddington-Monroe Rd	Matthews	NC	28104	(704) 843-4100
RALTE, Zothan Sanga	3565 M L King Jr Blvd	New Bern	NC	28562	(252) 514-0060
SUN, Roni Stewart	305 Ivey Lane	Pinehurst	NC	28374	(910) 255-0104
KI, Lai Mang	9600 Falls of Neuse Rd.	Raleigh	NC	27615	(919) 676-6614
MYINT, Khin Than	500 Oberlin Rd.	Raleigh	NC	27605	(919) 828-9216
SAILO, Biakhnuna	4221 Corners Pkwy	Raleigh	NC	27617	(919) 596-5399
DARA, Thoon	120-100 St. Albans Drive	Raleigh	NC	27609	(919) 781-4165
MYINT, Htay Htay	3501 Oleander Drive	Wilmington	NC	28403	(910) 343-4216
THU, Kyaw	3860 Carolina Beach Rd	Wilmington	NC	28412	(910) 444-0241
LWIN, Khun Nay Myo	45 South Park Street	Hanover	NH	3755	(603) 643-2667
OO, Sann Tun	12 Centerra Pkwy	Lebanon	NH	3766	(603) 643-4889
DINGZHEN WANGDUI, FNU	370 Miracle Mile Road	Lebanon	NH	3766	(603) 448-3970
DINGZHEN WANGDUI, FNU	285 Plainfield Road	West Lebanon	NH	3784	(603) 298-9670
YANG, DONGHYUN	3339 Las Vegas Blvd	Las Vegas	NV	89109	(702) 369-8166
HMINE, Sai Naw	1086 E Second St.	Reno	NV	89502	(775) 982-4100
HTUN, Win Min	113 Holland Avenue	Albany	NY	12209-3410	(518) 626-5000
THANG, Moug	1060 Madison Ave	Albany	NY	12208	(518) 438-6241
AUNG, Nwe Nwe	43 New Scotland Ave.	Albany	NY	12208	(518) 262-3125
THIRI, Yamin	40 Delaware Avenue	Albany	NY	12210	(518) 465-2603
NYEIN, Chan	141 Sanford Farm Plaza	Amsterdam	NY	12010	(518) 843-0056
BAW, NI	10 Glenwood Avenue	Binghamton	NY	13905	(607) 770-7151
BAW, NI	33 Chenango Bridge Road	Binghamton	NY	13901	(607) 235-7240
AUNG, Naing W.	860 Route 11	Champlain	NY	12919	(518) 298-4200
AWI, Lian Cung	5701 E. Circle Drive	Cicero	NY	13039	(315) 458-2056
MARIP, Seng Naw	15 Park Ave	Clifton Park	NY	12065	(518) 371-9107
MYINT, Win	1028 Route 146	Clifton Park	NY	12065	(518) 371-6155
SOE, Myo Min Min	240 Congress Street	Cohoes	NY	12047	(518) 237-6050
HTUN, Win Min	1730 Central Avenue	Colonie	NY	12205	(877) 233-9072
KAI, Ngun	354 Broadway	Fort Edward	NY	12828	(518) 832-6236
LY, Chan	12 West 1st Street South	Fulton	NY	13069	(315) 598-4000
MYO, Khine	2614 Route 66	Ghent	NY	12034	(518) 392-9007
THIRI, Yamin	329 Glenmont Road	Glenmont	NY	12077	(518) 433-4700
NYEIN, Chan	358 North Main Street	Gloversville	NY	12078	(518) 775-1464
KEE, Moug	2080 Western Ave	Guilderland	NY	12084	(518) 456-5115
THANG, Moug	1706 Western Ave	Guilderland	NY	12203	(518) 456-0403
BAW, NI	1050 Madison Market Place	Hamilton	NY	13346	(315) 824-6040

AFC Food Service Counters

Franchise List

As of March 31, 2025

Franchisee Name	Address	City	State	Zip	Phone
NYEIN, Chan	241 North Comrie Ave	Johnstown	NY	12095	(518) 762-8981
SWE, Kyi Kyi	873 New Loudon Road	Latham	NY	12110	(518) 782-0441
NRAW KAWNG, Mung Hkyen La	475 Albany-Shaker Road	Loudonville	NY	12211	(518) 459-8720
HMUNG, Matthew Hramcin	1 Kendall Way	Malta	NY	12020	(518) 899-2438
MARIP, Seng Naw	1 Price Chopper Plaza	Mechanicville	NY	12118	(518) 664-1112
OO, Saw Aung Lin	4535 Commercial Drive	New Hartford	NY	13413	(315) 736-8376
MOE, Aung Maw	115 Temple Hill Rd	New Windsor	NY	12553	(845) 565-8637
NAING, Ye Myint	24 E. 101 Street	New York	NY	10029	(212) 241-6500
MOE, Aung Maw	39 N Plank Road	Newburgh	NY	12550	(845) 569-2620
SAN, May	2333 Nott Street East	Niskayuna	NY	12309	(800) 666-7667
HMUNG, Matthew Hramcin	102 Van Rensselaer Square	North Greenbush	NY	12144	(877) 233-9072
RAJA, FNU	981 Ford St Ext	Odgensburg	NY	13669	(315) 393-7153
BAW, NI	142 Genesee Street	Oneida	NY	13421	(315) 363-8927
LY, Chan	137 State Route 104	Oswego	NY	13126	(315) 342-0571
AUNG, Naing W.	19 Centre Drive	Plattsburg	NY	12901	(518) 562-3560
KAI, Ngun	677 Upper Glen Street	Queensbury	NY	12804	(518) 792-7456
MYO, Khine	501 Columbia Turnpike	Rensselaer	NY	12144	(518) 479-4380
BAW, NI	1790 Black River Blvd	Rome	NY	13440	(315) 337-5086
LIAN, Biak Za	115 Ballston Ave	Saratoga	NY	12866	(518) 580-9172
JIANG, Jian Qing	3045 RT 50	Saratoga Springs	NY	12866	(518) 583-7551
MANG, Zung	1640 Easter Parkway	Schenectady	NY	12309	(518) 372-6553
MANG, Zung	442 Balltown Road	Schenectady	NY	12304	(518) 346-0182
NRAW KAWNG, Mung Hkyen La	1879 Altamont Ave	Schenectady	NY	12303	(518) 357-4050
SOE, Khaing	290 Saratoga Road	Scotia	NY	12302	(518) 399-4011
MYINT, Myo	1395 New Scotland Road	Slingerlands	NY	12159	(518) 478-0688
ZAM, Tha Hlei	2515 Erie Blvd East	Syracuse	NY	13224	(315) 449-2314
AWI, Lian Cung	4713 ONONDAGA BLVD	Syracuse	NY	13219	(315) 472-3812
SOE, Myo Min Min	716 Hoosick Road	Troy	NY	12180	(518) 266-9035
NRAW KAWNG, Mung Hkyen La	79 Vandenberg Ave	Troy	NY	12180	(518) 459-8720
OO, Saw Aung Lin	1917 Genesee Street	Utica	NY	13501	(315) 732-1031
OO, Saw Aung Lin	50 Auert Ave	Utica	NY	13501	(310) 732-0507
NAING, Ye Myint	100 Woods Road	Valhalla	NY	10595	(914) 493-1407
SWE, Kyi Kyi	515 19th Street	Watervliet	NY	12189	(518) 271-7446
LEONG, Thandar	4450 Eastgate S. Blvd	Cincinnati	OH	45245	(513) 674-6000
THANG, Tawk Za	234 Goodman Street	Cincinnati	OH	45219	(513) 584-1000
SAR, Hong	9500 Euclid Ave	Cleveland	OH	44195	(216) 444-2200
LATT, Khin Maung	5440 Dixie Hwy.	Fairfield	OH	45014	(513) 674-6046
PU, Tuang	4300 W. Memorial Road	Oklahoma City	OK	73120	(405) 755-1515
LIAN, Thang	825 Stanton L Young Blvd	Oklahoma City	OK	73104	(405) 271-4700
LIAN, Thang	1000 N Lee Ave.	Oklahoma City	OK	73102	(405) 272-7000
NAING, Tun Tun	1121 NW Newport Ave	Bend	OR	97703	(541) 382-3940
ZAW, Nyi Nyi	160 S Fir St,	Sisters	OR	97759	(541) 549-0711
ZAW, Nyi Nyi	8431 11th Street	Terrebonne	OR	97760	(541) 382-3940
YUAN, Li Q	1200 South Cedar Crest Blvd.	Allentown	PA	18105	(610) 402-8000
CAI, Yingchao	2400 Chew Street	Allentown	PA	18104	(484) 664-3100
LIAN, Henry Hrang	500 University Drive	Hershey	PA	17033	(717) 531-8521
PENG, Van	3400 Spruce St.	Philadelphia	PA	19104	(215) 662-2155
PENG, Van	1 Convention Ave	Philadelphia	PA	19104	(215) 662-4000
ASSER, Michael	4401 Penn Ave	Pittsburgh	PA	15224	(412) 692-5325
NGE, Htay Htay	23 Coventry Shoppers Park	Coventry	RI	2818	(401) 615-9975
SHADAU, Dinu	550 Pontiac Ave.	Cranston	RI	2910	(401) 270-0887
MA, Kimberly Paochen	2077 Diamond Hill Road	Cumberland	RI	2864	(401) 333-7979
SOE, Nang Ohmar	1000 Division Rd	East Greenwich	RI	2818	(401) 558-0190
KYUE, Hla Myint	105 Gate Road	North Kingstown	RI	2852	(401) 295-0019
NYI, Nyi	125 Tower Hill Road	North Kingstown	RI	2852	(401) 268-3991
MA, Kimberly Paochen	371 Putnam Pike	Smithfield	RI	2917	(401) 231-1620
MA, Kimberly Paochen	4 Cedar Swamp Rd	Smithfield	RI	2917	(401) 231-1620
HPAU JAN, Brang Saing	18 Airport Road	Warwick	RI	2889	(401) 738-8300
HPAU JAN, Brang Saing	2574 West Shore Rd	Warwick	RI	2889	(401) 737-5860
SUNG, Za Meng	163 Sea Island Parkway	Beaufort	SC	29907	(800) 432-6111
MANG, Pum L.	165 Ashley Ave	Charleston	SC	29425	(843) 792-2300
TUNE, Joseph	3865 West Ashley Circle	Charleston	SC	29414	(843) 619-2901
LYAN, Venus Parchin	1720 Augusta St.	Greenville	SC	29605	(864) 977-8041
PIANG, Steven	100 Wade Hampton Blvd	Greenville	SC	29609	(864) 900-6150
LAL, Biaktin Sung	2015 Old Spartanburg Rd	Greer	SC	29650	(864) 584-7301
HLAWNNUJAL, Valpuia	515 Freshfield Dr	Johns Island	SC	29455	(843) 243-3276
BIK, Thawng Tha	2035 Hwy 41	Mt. Pleasant	SC	29466	(843) 971-3611
THANG, Ngim Kim	1269 Nexton Parkway	Summerville	SC	29486	(843) 974-9474
MYINT, Cho Cho	1516 E. St. Patrick St	Rapid City	SD	57703	(605) 343-4326
MYINT, Cho Cho	751 Mountain View Rd	Rapid City	SD	57702	(605) 399-1377
YANG, Hong	1 Medical Park Blvd	Bristol	TN	37620	(423) 341-7129
LIN, Yen-Hsiang	4666 Nashville Hwy.	Chapel Hill	TN	37034	(931) 364-7315

AFC Food Service Counters

Franchise List

As of March 31, 2025

Franchisee Name	Address	City	State	Zip	Phone
Win, Shwe Yee	620 Skyline Drive	Jackson	TN	38301	(731) 541-5000
KHUP, Pau Khan	300 Med Tech Pkwy.	Johnson City	TN	37604	(423) 302-1000
KHUP, Pau Khan	400 N State of Franklin Rd	Johnson City	TN	37604	(423) 431-6111
LIN, Huiyu	877 Jefferson Ave	Memphis	TN	38013	(901) 545-7100
MUNG, Cin Sian	3975 Airways Blvd	Memphis	TN	38116	(901) 922-1666
PIANG, Theng Kual Kim	Ascension Saint Thomas Midtown 2000 Church Street	Nashville	TN	27203	(615) 284-5555
MANG, Rebeccayex Khuat	4220 Harding Pike	Nashville	TN	37205	(615) 222-2111
TOE, Nan Shw Mye	1 Tesla Rd.	Austin	TX	78725	(512) 516-8177
GUALNAM, Tuang Donggel	12100 Samsung Blvd	Austin	TX	78754	(512) 672-1000
TOE, Nan Shw Mye	11500 N Mopac Expy	Austin	TX	78759	(512) 291-6192
THANG, Francis	3500 Gaston Ave.	Dallas	TX	75246	(214) 820-0111
TIO-HLEI, Elizer	5909 Harry Hines	Dallas	TX	75235	2146450141
THANG, Francis	3500 Gaston Ave.	Dallas	TX	75246	(214) 820-0111
THANG, Francis	3500 Gaston Ave	Dallas	TX	75246	(214) 820-0111
SUNG, Cinthluai	5200 Harry Hines Blvd.	Dallas	TX	75235	(214) 590-8000
THAWNG, Van Mang	1441 North Beckley Ave	Dallas	TX	75203	(214) 947-0000
CEU, Moly	1301 Pennsylvania	Fort Worth	TX	76104	(817) 250-2000
LIAN, Hau Suan	1 Lockheed Martin Blvd	Fort Worth	TX	76108	(310) 535-3500
SANG, Tawt Hlei	4440 American Blvd.	Fort Worth	TX	76155	(800) 290-3433
SENG, Aung	150 N Dairy Ashford Rd.	Houston	TX	77079	(832) 337-2000
MUNG, Pau Suan	6565 Fannin Street	Houston	TX	77030	(713) 790-2571
DOI, Htoi San	1400 Pressler St	Houston	TX	77030	(713) 792-2121
HAU, Dim Deih	2103 CityWest Blvd.	Houston	TX	77042	(281) 822-3800
TIAL, Eunice I	7105 Corporate Drive	Plano	TX	75024	(800) 522-4317
MARUMOTO, Yoshikazu	6565 Headquarters Drive	Plano	TX	75024	(888) 255-3154
BAU, Zyon	22777 Springwoods Village Parkway	Springs	TX	77389	(800) 537-5200
HKAWNG, Visit R Dau	2401 South 31st Street	Temple	TX	76508	(254) 724-2111
JIA, Hongyan	42015 Village Center Plaza	Aldie	VA	20105	(703) 542-8340
LEI, LUBANG	4550 King Street	Alexandria	VA	22302	(571) 895-2820
HTET, Nyi Lin	735 N. Saint Asaph St.	Alexandria	VA	22314	(703) 419-3837
LAL, Hmun	4641 Duke St.	Alexandria	VA	22304	(703) 461-7082
MANG, Lai San	4000 Arlington Blvd	Arlington	VA	22204	(703) 302-6758
PHYO, Maung Wai	3600 Glebe Rd.	Arlington	VA	22202	(703) 412-1544
Aung, Wai Wai	950 S George Mason Dr.	Arlington	VA	22204	(571) 384-1610
MANG, Lai San	4000 Arlington Blvd	Arlington	VA	22204	(703) 302-6758
MAUNG, Lei Win	2425 N. Harrison St.	Arlington	VA	22207	(703) 532-8663
AUNG, Khant Hmue	624 N Glebe Road	Arlington	VA	22203	(703) 526-9100
LAHTAW, Seng Bu	975 Emmet St. N	Charlottesville	VA	22903	(434) 984-2900
ONG, Francis	1215 Lee Street	Charlottesville	VA	22903	(434) 924-0211
OO, Aung Myo	301 West Broad Street #A	Falls Church	VA	22046	(571) 419-6869
SU, Myat The	8200 Crestwood Heights Dr.	McLean	VA	22102	(703) 448-0132
AUNG, Han Win	600 Gresham Drive	Norfolk	VA	23507	(757) 388-3000
AUNG, Han Win	1320 Colonial Ave.	Norfolk	VA	23517	(757) 533-9284
TUALLAWT, Malsawm Sanga	105 Purcellville Gateway Drive	Purcellville	VA	20132	(540) 338-8995
GREGOIRE, Sunyng Kim	11806 Spectrum Center	Reston	VA	20190	(703) 435-5800
NAING, Kaung Htat	21399 Epicerie Plaza	Sterling	VA	20164	(571) 526-4835
AUNG, Khant Hmue	2675 Avenir Place	Vienna	VA	22180	(703) 204-0840
AYE, Thida	2110 Great Neck Sq	Virginia Beach	VA	23454	(757) 481-6254
REYES, Geraldine Garcia	1069 Independence Blvd	Virginia Beach	VA	23455	(757) 217-0240
LOME, Shan	1470 Quarterpath Rd.	Williamsburg	VA	23185	(757) 253-0182
SONG, Moon Keun	1840 Amherst Street	Winchester	VA	22601	(540) 536-8000
OO, Zaw	168 Ames Drive	Barre	VT	5641	(802) 479-9078
VILASA, FNU	214 Northside Drive	Bennington	VT	5201	(802) 447-9940
PHYO, Wai	499 Canal Street	Brattleboro	VT	5301	(802) 254-3424
TINT, Kyaw	595 Shelburne Road	Burlington	VT	5401	(802) 651-9826
TINT, Kyaw	90 Center Road	Essex Junction	VT	5452	(802) 878-5163
SHWE, U Than	38 Rutland Shop Plaza	Rutland	VT	5701	(802) 747-7880
TINT, Kyaw	41 Hinesburg Road	South Burlington	VT	5403	(802) 864-9176
WIN, Chaw Su	857 Memorial Dr.	St Johnsbury	VT	5819	(802) 748-1109
SHWE, U Than	100 Westway Mall Drive	West Rutland	VT	5777	(802) 438-6119
KHINE, Ei Kay	3003 West Casino Road	Everett	WA	98204	(425) 342-3275
LIN, Kyaw Zayyar	5010 Point Fosdick	Gig Harbor	WA	98335	(253) 858-4842
LWIN, Min Min	10611 N.E. 68th Street	Kirkland	WA	98033	(206) 923-5212
AYE, Phyu Phyu	2755 77th Ave SE	Mercer Island	WA	98040	(206) 232-2577
HTWE, Mawi	900 Logan Avenue N	Renton	WA	98055	(425) 572-3172
SAN, Lal Rin	301 228th Ave SE	Sammamish	WA	98074	(425) 295-0456
KYAW, Min Thu	2320 42nd SW	Seattle	WA	98116	(206) 937-0551
NYUNT, Win Htut	5250 40th Ave NE	Seattle	WA	98105	(206) 938-6600
THANG, Par Tin Dim	7755 East Marginal Way South	Seattle	WA	98108	(206) 655-1341
U, Hsu Mon	8350 15th Ave. NW	Seattle	WA	98117	(206) 776-2900
NYO, Htay	2021 7th Avenue	Seattle	WA	98109	(206) 266-4064
KYAW, Min Thu	100 Mercer St.	Seattle	WA	98109	(206) 213-0778

AFC Food Service Counters

Franchise List

As of March 31, 2025

Franchisee Name	Address	City	State	Zip	Phone
KYAW, Min Thu	3830 34th Ave West	Seattle	WA	98199	(206) 283-2710
LIN, Kyaw Zayyar	2420 N. Proctor St.	Tacoma	WA	98406	2537613663

If you buy this franchise, your contact information may be disclosed to other buyers when you leave the franchise system.

AFC Food Service Counters
Company Owned Locations
As of March 31, 2025

Operator Name	Address	City	State	Zip	Phone
AFCFC	505 Yukon Dr	Fairbanks	AK	99775	(907) 474-7034
AFCFC	1800 Honda Drive	Lincoln	AL	35096	(205) 355-5000
AFCFC	2105 E South Blvd	Montgomery	AL	36116	(334) 288-2100
AFCFC	14214 Southgate Plaza	Guntersville	AL	35976	(256) 582-3470
AFCFC	313 Sand Mountain Drive	Albertville	AL	35950	(256) 891-0390
AFCFC	142 E State Hwy 260	Payson	AZ	85541	(928) 474-4495
AFCFC	1400 S Dobson Rd	Mesa	AZ	85202	(480) 412-3000
AFCFC	4855 E Warner Rd.	Phoenix	AZ	85044	(480) 496-8191
AFCFC	15480 W Waddell Rd	Surprise	AZ	85379	(623) 214-6460
AFCFC	1761 E. Warner Rd	Tempe	AZ	85284	(480) 839-9778
AFCFC	3275 N. Swan Rd.	Tucson	AZ	85712	(520) 323-5820
AFCFC	16605 E. Palisades	Fountain Hills	AZ	85268	(480) 391-4020
AFCFC	160 Coffee Pot Drive	Sedona	AZ	86336	(928) 282-5351
AFCFC	1221 W. Irvington Road	Tucson	AZ	85714	(520) 434-6920
AFCFC	4940 S Gilbert Rd	Chandler	AZ	85249	(480) 883-2240
AFCFC	3440 E. Flair Drive	El Monte	CA	91731	(800) 869-3557
AFCFC	217 Soscol Ave	Napa	CA	94559	(707) 224-7897
AFCFC	8852 Lakewood Dr.	Windsor	CA	95492	(707) 838-6604
AFCFC	367 West Main St.	Woodland	CA	95695	(530) 666-1156
AFCFC	3330 North Texas St.	Fairfield	CA	94533	(707) 421-9990
AFCFC	1407 Fulton Rd.	Santa Rosa	CA	95403	(707) 546-3435
AFCFC	2400 Sand Creek Rd	Brentwood	CA	94513	(925) 513-9400
AFCFC	1300 N. Vermont Ave	Los Angeles	CA	90027	(213) 413-3000
AFCFC	401 M St SE	Washington	DC	20003	(202) 554-0164
AFCFC	1500 South Capitol Street	Washington	DC	20003	(202) 675-6287
AFCFC	200 SE Hospital Ave 14 City	Stuart State	FL	34994	(772) 287-5200
AFCFC	Georgia College State University	Milledgeville	GA	31061	(478) 445-8646
AFCFC	10000 W Balmoral Ave.	Chicago	IL	60666	(773) 582-5852
AFCFC	5700 S Cicero Ave	Chicago	IL	60638	(786) 641-6030
AFCFC	151 Engineering Way	Georgetown	KY	40324	(502) 642-2000
AFCFC	612 S. Minnesota Ave.	St. Peter	MN	56082	(507) 931-5541
AFCFC	600 Battleground Drive	Iuka	MS	38852	(662) 423-9595
AFCFC	138 Ulster Ave.	Saugerties	NY	12477	(845) 247-4500
AFCFC	709 Central Avenue	Albany	NY	12206	(518) 482-0280
AFCFC	2585 South Road	Poughkeepsie	NY	12601	(845) 452-1005
AFCFC	854 State Route 13	Cortland	NY	13045	(607) 756-4994
AFCFC	320 W Bridge St.	Catskill	NY	12414	(518) 943-3239
AFCFC	911 North St.	Endicott	NY	13760	(607) 748-8080
AFCFC	1 Procter and Gamble Plz	Cincinnati	OH	45202	(513) 983-1100
AFCFC	1025 Pennsylvania Ave	Matamoras	PA	18336	(570) 491-5612
AFCFC	180 Westside Mall	Edwardsville	PA	18704	(570) 287-7244
AFCFC	1228 O'Neill Highway	Dunmore	PA	18512	(570) 346-4538
AFCFC	1026 Wyoming Ave	Wyoming	PA	18644	(570) 693-3997
AFCFC	245 Wilkes Barre Township Blvd	Wilkes Barre	PA	18702	(570) 825-0830
AFCFC	100 N Cedar Ave	South Pittsburg	TN	37380	(423) 837-2386
AFCFC	1755 Gunbarrel RD	Chatanooga	TN	37421	(423) 680-8000
AFCFC	975 East 3rd Street	Chatanooga	TN	37403	(423) 778-7000
AFCFC	10000 Energy Drive	Spring	TX	77389	(832) 796-1000
AFCFC	10300 Energy Drive	Spring	TX	77389	(650) 857-1501
AFCFC	501 Westlake Park Blvd.	Houston	TX	77079	(281) 366-2000
AFCFC	170 Swanton Rd. Rte. 7	St. Albans	VT	5478	(802) 524-2033
AFCFC	22833 SE Black Nugget Rd.	Issaquah	WA	98029	(206) 727-3200

AFC Food Service Counters
List of Franchisees Who Transferred
By the End of March 31, 2025

FC Name	Address	City	State	Zip	Phone
PINMANEE, Chanaporn	11825 Spyglass Cir	Anchorage	AK	99515	(907) 250-0919
RAO, Jianhui	5513 Big Creek Way	Elk Grove	CA	95758	(714) 725-9183
QIWEN XU INC.	8983 Hafinger Way	Elk Grove	CA	95757	(916) 670-8299
ROT, Nai Saikae	4743 W 137th St.	Hawthorne	CA	90250	(252) 259-7197
KYI, Kyaw Zwa	9519 Cherry Grove Circle	Sacramento	CA	95829	(916) 996-9436
TUN, Ko Ko	10702 E Exposition Ave.	Aurora	CO	80012	(720) 403-1294
KYAW, Thura	5 Quail Dr	Tariffville	CT	06081	(917) 435-8303
TSAI, Yaohuo	1275 Winsted Rd	Torrington	CT	06790	(929) 302-0792
YAWONGTSANG, Tenzin	10 Palmer St.	Uncasville	CT	06382	(860) 383-9466
SAN RAKHINE LLC.	4307 38th St.	Des Moines	IA	50310	(515) 707-3825
KHUPPI LION CORP.	625 Holbrook DR	Idaho Falls	ID	83401	(208) 957-0557
KHUPPI LION CORP.	625 Holbrook DR	Idaho Falls	ID	83401	(208) 957-0557
LIAN, Kham Za	5236 S Capitol Ave.	Indianapolis	IN	46217	(620) 765-0250
NWEE, Naw Phaw	4315 Bellmore St	Bel Aire	KS	67220	(641) 691-3615
LIAN, Philip Ral Bawi	7921 Yecker Ave	Kansas	KS	66109	(402) 201-8237
LAMUNG, Ah Hkawm	121 Kingston Ave, Apt 1	Louisville	KY	40214	(602) 422-0266
KO, Aung Ko	225 Silver St	Greenfield	MA	01301	(937) 432-8491
LWIN, Zarli	111 Mary Coburn Rd	Springfield	MA	01129	(415) 810-3884
MAUNG, Yarzar Maung	2908 Crestwood Dr. NE	Alexandria	MN	56308	(214) 677-6229
WANGDUE, Tsering	5300 Vernon Ave. S	Edina	MN	55436	(929) 418-5690
FAM, Ngun Tha	10259 Ohio St	Omaha	NE	68134	(402) 213-8009
SUNG, Bawi Tha Hnem	11422 Nebraska Cir	Omaha	NE	68164	(531) 247-9158
SUNG, Bawi Tha Hnem	11422 Nebraska Cir	Omaha	NE	68164	(531) 247-9158
NGE, Nu Nu	9505 Flint Rock Drive	Albuquerque	NM	87114	(806) 443-3375
NGE, Nu Nu	9505 Flint Rock Drive	Albuquerque	NM	87114	(806) 443-3375
NGE, Nu Nu	9505 Flint Rock Drive	Albuquerque	NM	87114	(806) 443-3375
THAWNG, Van Ram	2621 Maria Casas St.	El Paso	TX	79938	(214) 723-0521
KHUP, Twe Nei	14835 SE 306th St.	Kent	WA	98042	(206) 370-4061

If you buy this franchise, your contact information may be disclosed to other buyers when you leave the franchise system.

AFC Food Service Counters
Terminated List
As of March 31, 2025

Franchisee Name	Address	City	State	Zip	Phone
Castillo, Lesly	160 Richeytown rd	Eastaboga	AL	36260	(256) 419-6621
Sang, Cung Kip	1398 County Road 8	Heflin	AL	36264-3641	(317) 675-9553
Sang, Cung Kip	1398 County Road 8	Heflin	AL	36264-3641	(317) 675-9553
MOHAMMED KASSIM, Noor Bahar Binti	234 W Southern Ave	Phoenix	AZ	85041	(619) 416-8143
HMUNG, No Tin	10455 E. Via Linda #132	Scottsdale	AZ	85258	(857) 385-6826
HMUNG, No Tin	10455 E. Via Linda #132	Scottsdale	AZ	85258	(857) 385-6826
ASIAN BLISS	2533 Natomas Crossing Dr	Sacramento	CA	95834-4025	(916) 893-3066
BYATSAR CORP.	5264 Yerba Buena Rd	Santa Rosa	CA	95409-3837	(707) 694-3683
SONDOR ENTERPRISE LLC.	2424 Snowberry Cir	West Sacramento	CA	95691	(916) 475-4698
SONDOR ENTERPRISE LLC.	2424 Snowberry Cir	West Sacramento	CA	95691	(916) 475-4698
MYO , Hla	5800 Balsam Dr	Fort Pierce	FL	34982-3761	(954) 789-8056
HUM, Stewart T	170 Garrett Dr.	Eatonton	GA	31024	(919) 302-5895
CIN, Hmung Cung	161 Robinson Way	Lexington	KY	40511	(252) 349-1280
KUNG, Khua	2700 Ambassador Cafferry Pkwy	Lafayette	LA	70506	(402) 913-8455
DOOT, Mon	60 Winnipeg Ave	Saint Paul	MN	55117	(260) 441-6523
DOOT, Mon	60 Winnipeg Ave	Saint Paul	MN	55117	(260) 441-6523
GARDEA, MAYRA	107 RAINEY LANE	New Albany	MS	38652	(859) 693-2240
PHOBYA, Shiphe	317 Pleasantview Ave.	Syracuse	NY	13208-3148	(315) 885-8466
MANG, Ester	527 NW 44th St.	Oklahoma City	OK	73118-6608	(405) 371-1838
NAING, Win	201 Welles St.	Forty Fort	PA	18704-4948	(518) 207-8043
LAL, Thang Sian	516 Carriage Parc Dr	Chattanooga	TN	37421-7158	(405) 651-2833
LAL, Thang Sian	516 Carriage Parc Dr	Chattanooga	TN	37421-7158	(405) 651-2833

If you buy this franchise, your contact information may be disclosed to other buyers when you leave the franchise system.

AFC Food Service Counters
 Non-Renewal List
 as of March 31, 2025

FCName	Address	City	State	Zip	Phone
VIAL, Tuan Sung	1029 Joyce Dr.	Fairbanks	AK	99701	(214) 529-4451
BIK, Pa	4001 W El Camino Dr.	Phoenix	AZ	85051	(602) 384-4478
ZOU, Meiqi	5827 Zoller Ct.	Elk Grove	CA	95757	(916) 267-7969
ZOU, Meiqi	5827 Zoller Ct.	Elk Grove	CA	95757	(916) 267-7969
WIN & MAW 2005 LLC.	1210 Shaffer Rd.	Santa Cruz	CA	95060	(919) 601-6861
CHONG, Sun	1618 Woodcrest Circle	Mundelein	IL	60060	(847) 810-9304
SHON, Jeong Nock	411 Brown St.	Wauconda	IL	60084	(816) 739-5431
LI, Xiaoping	1121 Garden Stone Ct.	Clarksburg	MD	20871	(301) 908-4213
LAL, Cung Uk	2157 Stanford Dr. SE	Grand Rapids	MI	49508	(616) 304-0243
SOE, Thu Ra	736 Pritchard Park Ave.	Chapel Hill	NC	27516	(919) 756-9352
THANG, Peter Hrang Lian	2509 Briarcliff Circle	Wilmington	NC	28411	(317) 246-8059
THANG, Awn Kee	263 Myrtle Ave 2 FL	Albany	NY	12208	(518) 542-2480
LIAN, Heaven Thapeng	2701 SE 95th St	Moore	OK	73160	(972) 815-7134
MOUA, Tania Manena Vang	3203 SE 26TH ST.	Gresham	OR	97080	(971) 293-8490

If you buy this franchise, your contact information may be disclosed to other buyers when you leave the franchise system.

AFC Food Service Counters
List of Franchises Reacquired by Franchisor
As of End of March 31, 2025

Name	Address	City	State	Zip	Phone
Sang, Cung Kip	313 Sand Mountain Drive	Albertville	AL	35950	(256) 891-0390
Sang, Cung Kip	14214 Southgate Plaza	Guntersville	AL	35976	(256) 582-3470
Castillo, Lesly	2105 E South Blvd	Montgomery	AL	36116	(334) 288-2100
MOHAMMED KASSIM, Noor Bahar Binti	1400 S Dobson Rd	Mesa	AZ	85202	(480) 412-3000
HMUNG, No Tin	4855 E Warner Rd.	Phoenix	AZ	85044	(480) 496-8191
HMUNG, No Tin	1761 E. Warner Rd	Tempe	AZ	85284	(480) 839-9778
HTAY, Khin Maung	1465 Town and Country Dr.	Santa Rosa	CA	95404	(707) 546-3663
AYUSH, Byamba	367 West Main St.	Woodland	CA	95695	(530) 666-1156
MYO, Hla	200 SE Hospital Ave 14 City	Stuart State	FL	34994	(772) 287-5200
HUM, Stewart T	Georgia College State University	Milledgeville	GA	31061	(478) 445-8646
CIN, Hmung Cung	151 Engineering Way	Georgetown	KY	40324	(502) 642-2000
GARDEA, MAYRA	600 Battleground Drive	luka	MS	38852	(662) 423-9595
NAING, Win	1228 O'Neill Highway	Dunmore	PA	18512	(570) 346-4538
LAL, Thang Sian	975 East 3rd Street	Chatanooga	TN	37403	(423) 778-7000
LAL, Thang Sian	1755 Gunbarrel RD	Chatanooga	TN	37421	(423) 680-8000

If you buy this franchise, your contact information may be disclosed to other buyers when you leave the franchise system.

AFC Food Service Counters
Ceased Operations
As of March 31, 2025

Name	Address	City	State	Zip	Phone
SANG, Sawm	6041 Cobblestone Court	Gulf Shores	AL	36542	(850) 582-7803
KAP, Thang Suan	6041 Cobblestone Ct	Gulf Shores	AL	36542	(904) 832-4922
MAUNG, Tun	190 Shelton Rd.	Madison	AL	35758	(214) 840-3589
LIAN, Chan	3920 Berwyn Dr S	Mobile	AL	36608	(470) 985-9007
MUNG, Hau Khan	6238 W Freeway LN	Glendale	AZ	85302	(602) 718-5439
MARAN, Grace	1751 Ellis Street	Concord	CA	94520	(385) 209-7169
MARAN, Grace	1751 Ellis Street	Concord	CA	94520	(385) 209-7169
MARAN, Grace	1751 Ellis Street	Concord	CA	94520	(385) 209-7169
WHITE MU DRA CORP.	87 Mahogany Dr.	S. San Francisco	CA	94080	(650) 255-4804
YK SUSHI INC.	2624 La Paloma Lane	Santa Cruz	CA	95062	(831) 566-0751
YK SUSHI INC.	2624 La Paloma Lane	Santa Cruz	CA	95062	(831) 566-0751
NAING, Shwe Bhone Myat	369 Woodford Ave.	Plainville	CT	06062	(315) 796-5926
JULING, INC.	321 SE 23rd Ter.	Cape Coral	FL	33990	(239) 699-5247
TANGSUWAN, Nate	4621 Calle Arenoso	Pensacola	FL	32514	(415) 233-3797
LIESEMEYER, June Hyunhee	98-1840 Apelekoka St.	Aiea	HI	96701	(808) 542-1922
CHEN, Min	8230 Kekaha Rd.	Kekaha	HI	96752	(808) 206-6570
BLAIDOOT, Monnya	6261 Valleyview Dr.	Fishers	IN	46038	(317) 629-1658
CIN, Hmung Cung	161 Robinson Way	Lexington	KY	40511	(252) 349-1280
MIN, Paing Soe	2601 Sandersville Rd.	Lexington	KY	40511	(941) 960-6663
JANG MAW, Dai Zin	11424 Oakpoint Ave	Baton Rouge	LA	70810	(225) 333-2326
BIK, Iang Ci	6243 Parterre Dr.	Baton Rouge	LA	70817	(410) 564-1712
LABU, Lawt Naw	585 Eagle Loop	Covington	LA	70433	(225) 447-2729
BAWI, Vannawl	205 Arbor Springs Dr.	Lafayette	LA	70506	(317) 771-5928
PA PA, Ah Li	200 Chapel Creek	Mandeville	LA	70471	(904) 802-2713
HKAWNG, Ze	8508 Dumonte Street	Matairie	LA	70003	(504) 205-4271
HPAKAWN, Ja Yung	613 E William David Pkwy	Metairie	LA	70005	(817) 897-7559
SPEARMAN, Teresa Tolentino	16233 Cortez Ave.	Prairieville	LA	70769	(225) 323-0482
VAN'S SUSHI, LLC.	676 Fairfield Loop	Slidell	LA	70458	(518) 312-9612
CHEN, Shi Ping	70 Stone School Road	Sutton	MA	01590	(860) 888-4399
MOE, Aung Soe	9809 Narragansett Parkway	College Park	MD	20740	(703) 347-5297
LIANG, GuoZhu	3325 Hobble Ct.	Ellicott	MD	21043	(443) 546-5922
ZIN, Thet Htar	2414 Elm Dr	White Bear Lake	MN	55110	(806) 341-7208
MAR, JOHN HOUNG	10900 E. Taylor Rd.	Gulfport	MS	39503	(832) 396-1871
KEE, MOUNG	5 Lupine Court	Albany	NY	12203	(518) 506-2267
AL WINBERT CORPORATION	2962 Ocean Ave	Brooklyn	NY	11235	(347) 856-1667
AL WINBERT CORPORATION	2962 Ocean Ave	Brooklyn	NY	11235	(347) 856-1667
MOE THIT LLC.	1 Muriel Ave	Rensselaer	NY	12144	(724) 612-8067
AWI, Lian Cung	405 E Molloy Rd.	Syracuse	NY	13211	(214) 777-3927
MANG, Kam Khan	3131 E 144 Pl. S.	Bixby	OK	74008	(251) 622-2910
PHAILENG INC.	11734 S Holley St.	Jenks	OK	74037	(561) 929-9926
NAING, Win	201 Welles St.	Forty Fort	PA	18704	(518) 207-8043
BOIH, Zam	2401 Grove Blvd	Austin	TX	78741	(469) 685-3091
GUALNAM, Tuang Donggel	3900 Black Granite Dr	Austin	TX	78744	(512) 796-0281
GUALNAM, Tuang Donggel	3900 Black Granite Dr	Austin	TX	78744	(512) 796-0281
GUALNAM, Tuang Donggel	3900 Black Granite Dr	Austin	TX	78744	(512) 796-0281
GUALNAM, Tuang Donggel	3900 Black Granite Dr	Austin	TX	78744	(512) 796-0281
GUALNAM, Tuang Donggel	3900 Black Granite Dr	Austin	TX	78744	(512) 796-0281
GUALNAM, Tuang Donggel	3900 Black Granite Dr	Austin	TX	78744	(512) 796-0281
LAHPAI, Zau Doi	16 Oakridge Ln	Edgecliff Village	TX	76134	(817) 449-6048
LIAN, Than	13 Cherryridge Dr.	Fort Worth	TX	76134	(972) 839-6697
THANG, Vanlian	14444 Desert Sage Dr.	Horizon City	TX	79928	(469) 671-1592
SAN, Kyaw Soe	8814 Shady Vista Ln	Houston	TX	77028	(228) 731-2122
THANG, Cung Lian	1232 Ottawa Lane	Lewisville	TX	75077	(469) 464-8591
THANG, Peng Lian	1309 Wildvalley Dr	Lewisville	TX	75067	(940) 594-8949
THAWNG, Van Mang	623 Woodway Ln	Richardson	TX	75081	(214) 650-8136
THAWNG, Van Mang	623 Woodway Ln	Richardson	TX	75081	(214) 650-8136

If you buy this franchise, your contact information may be disclosed to other buyers when you leave the franchise system.

Wild Blue Food Service Counters

Franchise List

As of March 31, 2025

Franchisee Name	Address	City	State	Zip	Phone
AUNG, Baby	350 Student Center Cir	Mobile	AL	36688	(251) 460-6101
KWAG, Giljong	1050 S. Knoles Drive	Flagstaff	AZ	86011	(928) 523-3975
AYE, Ko Thein	4701 W Thunderbird Road	Glendale	AZ	85306	(602) 543-5000
MAUNG, Win Htwe	5999 S. Backus Mall	Mesa	AZ	85212	(480) 727-1585
AUNG, Zay Zay	120 East Taylor Street	Phoenix	AZ	85004	(602) 614-7765
MUANG, Cin Za	3300 West Camelback Road	Phoenix	AZ	85017	(602) 639-7500
NA, Hyeon Mi	6500 Soquel Drive	Aptos	CA	95003	(408) 460-0199
ZAYAR, Nai	438 Plaza Ave	Arcata	CA	95521	(707) 826-3011
YU, Tianshu	11340 South St (B)	Cerritos	CA	90703	(888) 280-4331
XIAO, Xiang	5425 Sunrise Blvd	Citrus Heights	CA	95610	(800) 250-0668
TUN, Saw Thant Zin	7530 Elk Grove Blvd	Elk Grove	CA	95757	(800) 250-0668
KHAING, Myo Myo	16325 Ventura Blvd	Encino	CA	91436	(888) 280-4331
NOOKJUN, Supawatchara	16173 S Highland Avenue	Fontana	CA	92336	(800) 250-0668
LEE, Moonhee	1509 East Campus Drive	Fullerton	CA	92834	(657) 278-1661
Ma, Kun	1100 S Harbor Blvd	Fullerton	CA	92832	(888) 280-4331
THANG, Ngun	25800 Carlos Bee Blvd.	Hayward	CA	94542	(510) 885-4791
KIM, Taeho	6911 Warner Ave	Huntington Beach	CA	92647	(888) 280-4331
SOE, Maung Min	13672 Jamboree Rd	Irvine	CA	92602	(888) 280-4331
KIM, Taeho	1610 W Imperial Hwy	La Habra	CA	90631	(888) 533-5659
LAI, Dongquan	6235 E Spring St	Long Beach	CA	90808	(888) 280-4331
SHWE, Theingi	6855 S La Cienega Blvd	Los Angeles	CA	90045	(888) 599-5653
AUNG, Hnin Sandar	5101 Lankershim Blvd	Los Angeles	CA	91601	(888) 280-4331
Ji, Young Chel	742 E Los Angeles Ave	Moorpark	CA	93021	(888) 280-4331
PUANGCHAN, Phatsany Nina	40481 Murrieta Hot Springs Rd	Murrieta	CA	92563	(888) 280-4331
SEO, Byung Mo	18111 Nordhoff St.	Northridge	CA	91330	(818) 677-1200
SUSANTO, Cathrine Cahya	5000 MacArthur Blvd.	Oakland	CA	94613	(510) 430-2255
SOE, Steve	3425 E Colorado Blvd	Pasadena	CA	91107	(888) 280-4331
NANG, Nang	14837 Pomerado Road	Poway	CA	92064	(888) 280-4331
LIANG, Jingqiang	6780 Stanford Ranch Road	Roseville	CA	95678	(888) 280-4331
NOOKJUN, Supawatchara	5500 University Parkway	San Bernardino	CA	92407	(909) 537-5000
YAN, Shang Xiuzi	211 S. 9th Street	San Jose	CA	95192	(408) 924-1000
MAY, Kyu Kyu	211 S. 9th Street	San Jose	CA	95192	(408) 924-1000
PAING, Khin Ei Ei	Paseo de San Carlos	San Jose	CA	95112	(408) 924-1000
SAN, Tin	301 Market St.	Santa Clara	CA	95053	(408) 389-9380
THET, Naing	3118 Inter-Garrison Rd	Seaside	CA	93955	(831) 582-3000
WIN, Kyaw Zin Lat	140 Promenade Way	Thousand Oaks	CA	91362	(888) 280-4331
ZHANG, Qiang	21035 Hawthorne Blvd	Torrance	CA	90503	(888) 280-4331
HTIN, Henry	1 University Cir	Turlock	CA	95382	(209) 667-3666
LAU, James Pak-Kit	15225 Whittier Blvd	Whittier	CA	90603	(888) 280-4331
AUNG, Hnin Sandar	6245 Topanga Canyon Blvd	Woodland Hills	CA	91367	(888) 280-4331
NAWL, Zion Za	1100 North Avenue	Grand Junction	CO	81501	(970) 248-1020
SUSU, Chaw	168 Grove Street	New Haven	CT	06511	(203) 436-9127
MOE, Aung Soe	620 Michigan Ave NE	Washington	DC	20064	(202) 319-5000
HTOO, Hser Tha You	421 N Woodland Blvd	Deland	FL	32723	(386) 852-7000
AUNG , Yu Khine	Turlington Hall 330 Newell Dr.	Gainesville	FL	32603	(352) 392-2492
SHEMZA, Meerya	1000 Holt Ave	Winter Park	FL	32789	(407) 646-2000
GUO, Jenny Qiaodan	404 Georgia Circle	Dahlonega	GA	30597	(678) 717-3639
HMUNG, Nelson	404 W Army Trail Rd	Bloomington	IL	60188	(888) 280-4331
RUAN, Yun F.	828 S. Wolcott Ave	Chicago	IL	60612	(312) 996-7000
ENG, Sung	1351 E Ogden Ave	Naperville	IL	60563	(888) 280-4331
LIAN, Bawi Tha	3116 S. Route 59th	Naperville	IL	60564	(888) 280-4331
ENG, Za	7229 West 24th St.	North Riverside	IL	90546	(888) 280-4331
SWE, Min	16 East Golf Road	Schaumburg	IL	60016	(888) 280-4331
CHEN, Dingnan	900 East Seventh Street	Bloomington	IN	47405	(812) 855-4848
CHAN, Steven Samuel	6363 Saint Charles Ave. BOX 243	New Orleans	LA	70118	(504) 865-2014
HMUNG, Pyang Van	31 McAlister Drive	New Orleans	LA	70118	(504) 865-5294
ZA, Van Lal Cung	104 Ellendale-NSU Dr.	Thibodaux	LA	70310	(985) 852-1315
SUNNY, Seng	300 The Fenway	Boston	MA	02115	(617) 521-2000
XU, Hanchen	84 Massachusetts Ave	Cambridge	MA	02139	(617) 253-1000
XU, Han Qing	100 Main Market Place	Cambridge	MA	02139	(617) 324-1668
MAUNG, Shan Y	1215 Wilbraham Road	Springfield	MA	01119	(413) 782-3111
BIAN, Chao	415 South St.	Waltham	MA	02453	(781) 736-2000
MAUNG, Soe Lwin	24 Boynton St.	Worcester	MA	01605	(508) 831-5000
WOSE, Xirao	486 Chandler St	Worcester	MA	01602	(508) 752-1118
SU, Ma Su	1400 Townsend Drive	Houghton, MI	MI	49931	(906) 476-1885
LI, Yun	312 Meadow Brook Road	Rochester	MI	48309	(248) 370-2100
VANG, Payee	300 Washington Ave SE	Minneapolis	MN	55455	(612) 625-5000
YANG, Khoua	2004 Randolph Ave	St. Paul	MN	55105	(651) 690-8719
SENG, Htoi	17 Arnold Grobman Dr.	St. Louis	MO	63121	(314) 516-5451
MON, Myat Myat	511 South Holden Street	Warrensburg	MO	64093	(660) 543-4174
CHUM, Ngun	9201 University City Blvd	Charlotte	NC	28223	(704) 687-8622
Fachhai, Zan Thang	405 N Main Street	Davidson	NC	28035	(336) 698-5945

Wild Blue Food Service Counters

Franchise List

As of March 31, 2025

Franchisee Name	Address	City	State	Zip	Phone
Mawi, Sui Hlawm	100 Dalton McMichael Dr.	Elon	NC	27244	(336) 278-5333
HUNG KUNG, Zaw Win	1601 E. Market Street	Greensboro	NC	27411	(336) 455-6171
CHO, San	833 Montlieu Ave	High Point	NC	27262	(800) 345-6993
SAI, Soe Win	601 South College Rd.	Wilmington	NC	28403	(910) 962-3000
THANG, Kaam Sian	220 N Camden RD	Wingate	NC	28174	(704) 233-8000
MARTIN, SAM	1 Normal Ave	Montclair	NJ	07043	(973) 655-4036
THANG, Moung	1400 Washington Ave	Albany	NY	12222	(518) 442-3300
THANG, Moung	1400 Washington Ave	Albany	NY	12222	(518) 442-3300
AUNG, Naing W.	101 Broad St	Plattsburg	NY	12901	(518) 564-2000
HTING NAN, Brang Nan	1000 E. Henrietta Road	Rochester	NY	14623	(585) 292-2513
TUN NAING, Si Thu	807 Union Street	Schenectady	NY	12308	(518) 388-6000
AUNG, Nwe Nwe	15th Street and Sage Ave.	Troy	NY	12180	(518) 276-6000
XUE, Ying	283 Cleveland Ave	Columbus	OH	43215	(614) 287-5353
OO, Nilar	40 Rowland Ave., Spring	Delaware	OH	43015	(800) 928-8953
WU, Eric	1075 Risman Drive	Kent	OH	44242	(330) 672-2541
LI, Leah	135 W. Lorain St.	Oberlin	OH	44074	(330) 730-1950
MANG, Suan Kham	440 South Gary	Tulsa	OK	74104	(918) 631-2000
PAR, Di Cim	250 University Ave	California	PA	15419	(724) 938-4000
THET, Aye A	2755 Station Ave	Center Valley	PA	18034	(610) 282-1100
WANG, Wenpan	3330 Market Street	Philadelphia	PA	19148	(215) 895-2000
THAWNG LIAN, Melvin Ngun	3725 Sutherland Dr	Pittsburg	PA	15213	(412) 624-4141
THAWNG LIAN, Melvin Ngun	3595 Forbes Ave	Pittsburg	PA	15213	(412) 624-4141
THAWNG LIAN, Melvin Ngun	3301 Fifth Ave	Pittsburgh	PA	15213	(800) 333-2275
THAWNG LIAN, Melvin Ngun	3990 Fifth Ave (Cathedral)	Pittsburgh	PA	15213	(412) 624-4141
THAWNG LIAN, Melvin Ngun	3990 Fifth Ave	Pittsburgh	PA	15213	(412) 624-4141
THAWNG LIAN, Melvin Ngun	3990 Fifth Ave	Pittsburgh	PA	15213	(412) 624-4141
SAING, Ponnyar	4765 Forbes Ave	Pittsburgh	PA	15213	(626) 421-9606
Lian, Hrang Za	200 Campus Drive	Slippery Rock	PA	16057	(800) 778-9111
LYNN, Tin	1 Old Ferry Rd.	Bristol	RI	02809	(401) 254-3735
MANG, Rebeccaex Khuat	1 University Park Drive	Nashville	TN	37204	(615) 966-1000
LUN, Vung T	3001 S. Congress Ave	Austin	TX	78704	(512) 448-8400
SENG, Thkunmin	600 West Campus Blvd	College Station	TX	77843	(979) 458-1826
LIAN, Hram Hmun	1155 Union Circle	Denton	TX	76203	(940) 565-2000
HAU, Dim Deih	1 Main St	Houston	TX	77002	(713) 221-8000
KHAI, Hau Cin	4700 CALHOUN RD	Houston	TX	77204	(713) 743-2255
KHAI, Hau Cin	2700 Bay Area Blvd	Houston	TX	77058	(713) 221-8000
CHOIE, Salai Thang	1802 Avenue I	Huntsville	TX	77340	(936) 294-1111
LABYA, La Seng	2601 N. Floyd Rd. (SU-23)	Richardson	TX	75080	(972) 883-2111
CIAKIP, Tluang Hnin	11052 ASU Station	San Angelo	TX	76909	(325) 942-2555
CIN, Sui	2115 University Circle	Ogden	UT	84408	(801) 626-6000
LIN, Maung Htin	200 South Central Campus Drive	Salt Lake City	UT	84112	(801) 581-7200
DEMBEREL, Buyanbaatar	3801 Richmond Hwy	Alexandria	VA	22305	(888) 280-4331
TANG BAU, Ya Ku	395 South High Street	Harrisonburg	VA	22801	(540) 568-4543
TANG BAU, Ya Ku	800 S. Main Street	Harrisonburg	VA	22807	(540) 568-6211
HA, Yong Hui	1301 Carrier Dr.	Harrisonburg	VA	22807	(540) 568-6237
OO, Min Hlaing	590 Main St	Burlington	VT	05405	(802) 656-3131
MAWII, Lal	1701 S Commons	Federal Way	WA	98003	(800) 250-0668
LIAN, Za	901 12AVE	Seattle	WA	98122	(206) 296-6000
BO, Nai Bo Rot Mon	100 Grant St.	De Pere	WI	54115	(920) 403-3156
KYAW, Aung Khaing	800 W Main St.	Whitewater	WI	53190	(262) 472-1234

If you buy this franchise, your contact information may be disclosed to other buyers when you leave the franchise system.

Wild Blue Food Service Counters
Company Owned Locations
As of March 31, 2025

Operator Name	Address	City	State	Zip	Phone
AFCFC	1 University Dr.	Camarillo	CA	93012	(805) 437-8400
AFCFC	2229 Foothill Blvd	La Verne	CA	92691	(888) 280-4331
AFCFC	1250 Bellflower Blvd.	Long Beach	CA	90840	(562) 985-4111
AFCFC	1600 Campous Road	Los Angeles	CA	90041	(323) 259-2639
AFCFC	26940 Crown Valley Pkwy	Mission Viejo	CA	92691	(888) 280-4331
AFCFC	19340 Rinaldi St	Northridge	CA	91326	(818) 363-3933
AFCFC	22135 Hawthorne Blvd	Torrance	CA	90503	(888) 280-4331
AFCFC	14249 Whittier Blvd	Whittier	CA	90605	(888) 280-4331
AFCFC	22001 Ventura Blvd	Woodland Hills	CA	91364	(888) 280-4331
AFCFC	2200 Bonforte Blvd	Pueblo	CO	81001	(719) 549-2100
AFCFC	325 E Palatine Road	Arlington Heights	IL	60004	(888) 280-4331
AFCFC	3 W Chicago Ave.	Chicago	IL	60654	(888) 280-4331
AFCFC	222 W. Merchandise Mart Plaza	Chicago	IL	60654	(888) 280-4331
AFCFC	130 E. Randolph St	Chicago	IL	60601	(888) 280-4331
AFCFC	113 S Franklin St	Chicago	IL	60606	(888) 280-4331
AFCFC	500 W. Madison	Chicago	IL	60606	(888) 280-4331
AFCFC	6939 Dempster St	Morton Grove	IL	60053	(888) 280-4331
AFCFC	4211 N. Harlem Ave	Norridge	IL	60706	(888) 280-4331
AFCFC	4031 W 95th St.	Oak Lawn	IL	60453	(888) 280-4331
AFCFC	16017 S. Harlem Ave	Tinley Park	IL	60477	(888) 280-4331
AFCFC	30 W 63rd St	Westmont	IL	60559	(888) 280-4331
AFCFC	8525 Chevy Chase Lake Terrace	Chevy Chase	MD	20815	(800) 250-0668
AFCFC	5463 Wisconsin Ave	Chevy Chase	MD	20815	(888) 280-4331
AFCFC	15790 Shady Grove Rd	Gaithersburg	MD	20877	(888) 280-4331
AFCFC	6711 Ritchie Highway	Glen Burnie	MD	21061	(800) 250-0668
AFCFC	12263 PROSPERITY DRIVE	Silver Spring	MD	20904	(800) 250-0668
AFCFC	1200 Oakwood St.	Ypsilanti	MI	48197	(734) 487-1849
AFCFC	209 S Kingshighway St.	St. Charles	MO	63301	(636) 949-2000
AFCFC	200 College Dr.	Blackwood	NJ	08012	(856) 374-4965
AFCFC	137 Route 35	Eatontown	NJ	07724	(888) 280-4331
AFCFC	2 Memorial Drive	Lodi	NJ	07644	(888) 280-4331
AFCFC	30 E Ridgewood Ave	Paramus	NJ	07652	(888) 280-4331
AFCFC	1510 Route 46	Woodland Park	NJ	07424	(800) 250-0668
AFCFC	1600 International Mall	Las Cruces	NM	88003	(575) 646-0111
AFCFC	106 New Scotland Ave	Albany	NY	12208	(518) 694-7349
AFCFC	4054 Nesconset Highway	East Setauket	NY	11733	(800) 250-0668
AFCFC	3620 Long Beach Rd	Oceanside	NY	11572	(888) 280-4331
AFCFC	50 Manetto Hill Road	Plainview	NY	11803	(800) 250-0668
AFCFC	2924 Springfield Road	Broomall	PA	19008	(800) 250-0668
AFCFC	2424 E. Lincoln Hwy,	Langhorne	PA	19047	(800) 250-0668
AFCFC	389 Easton Rd	Warrington	PA	18976	(888) 280-4331
AFCFC	102 Park Ave.	Willow Grove	PA	19090	(800) 250-0668
AFCFC	10819 4th St. NE	Bellevue	WA	98004	(888) 280-4331
AFCFC	10360 Fairfax Blvd	Fairfax	VA	22030	(888) 280-4331
AFCFC	7005 Manchester Blvd	Franconia	VA	22310	(888) 280-4331
AFCFC	9409 Lorton Market St	Lorton	VA	22079	(888) 280-4331
AFCFC	3903 Factoria Blvd SE	Bellevue	WA	98006	(888) 280-4331
AFCFC	4008 132nd st SE	Mill Creek	WA	98012	(882) 280-4331
AFCFC	15518 Meridian Ave. E.	Puyallup	WA	98375	(888) 280-4331
AFCFC	17710 Canyon Road E #400	Puyallup	WA	98375	(888) 280-4331
AFCFC	1423 4th St	Seattle	WA	98101	(888) 280-4331
AFCFC	1906 Terry Avenue	Seattle	WA	98101	(888) 280-4331
AFCFC	1122 Madison St	Seattle	WA	98104	(888) 280-4331
AFCFC	300 Boren Ave	Seattle	WA	98109	(888) 280-4331
AFCFC	2131 7th Ave	Seattle	WA	98121	(888) 280-4331
AFCFC	13201 Aurora Ave N	Seattle	WA	98133	(888) 280-4331
AFCFC	2309 S Jackson St.	Seattle	WA	98144	(888) 280-4331

Wild Blue Food Service Counters
List of Franchisees Who Transferred
As of March 31, 2025

FC Name	Address	City	State	Zip	Phone
WADI CORP.	71 Park Manor Dr.	Daly City	CA	94015-3543	(626) 524-7468
ROT SAIKE MON CORP.	4743 W 137th St.	Hawthorne	CA	90250	(252) 259-7197
MISO UNG LLC.	68 White Oak Trl S	Dahlonega	GA	30533-9401	(646) 409-8972
SAN RAKHINE LLC.	4307 38th St.	Des Moines	IA	50310	(515) 707-3825
SUPERMAN SUSHI INC.	11 Captain Parker Arms	Lexington	MA	02421	(857) 316-8648
LIAM, Lin Ngun	4519 Cloverdale Ave	Charlotte	NC	28212-4807	(503) 935-3183
WIN, Maung Myo	601 S Williamson Ave.	Elon	NC	27244-9224	(810) 399-3149
NYEINNYEIN LLC.	5808 Election Oak Dr	High Point	NC	27265-3210	(484) 688-7430
SNOW SUSHI LLC.	1532 East 34th St.	Cleveland	OH	44114	(216) 926-2445
M&K FOODS AND TRADING SERVICES LLC.	435 Dorset St.	South Burlington	VT	05403	(315) 749-5393

If you buy this franchise, your contact information may be disclosed to other buyers when you leave the franchise system.

Wild Blue Food Service Counters
Terminated List
As of March 31, 2025

Franchisee Name	Franchisee Home Address	City	State	Zip	Phone
UK, Khrih Thian	45 N Main St	Glen Ellyn	IL	60137	(331) 551-1193
SIANSIAM LLC.	4998 Battery Lane	Bethesda	MD	20814	(440) 391-6213
TUAN, Mung Khan	4673 Helia Ave	Las Cruces	NM	88012	(575) 650-8418
TUN, Zin Zin	11305 SW Harlod St.	Portland	OR	97266	(702) 292-5627
BIK, Duh	250 University Ave	California	PA	15419	(463) 701-6851
Pyae, Hsu Latt	6346 Chimney Wood Court	Alexandria	VA	22306	(571) 562-0138
MAXIDINA INC.	4554 Trailhead Dr.	Crozet	VA	22932	(703) 459-4775

If you buy this franchise, your contact information may be disclosed to other buyers when you leave the franchise system.

**Wild Blue Food Service Counters
Non-Renewal List
As of March 31, 2025**

Name	Address	City	State	Zip	Phone
LAL, Cung Uk	2157 Stanford Dr. SE	Grand Rapids	MI	49508	(616) 304-0243
THANG, Awn Kee	263 Myrtle Ave 2 FL	Albany	NY	12208	(518) 542-2480

If you buy this franchise, your contact information may be disclosed to other buyers when you leave the franchise system.

Wild Blue Food Service Counters
List of Franchises Reacquired by Franchisor
As of End of March 31, 2025

Name	Address	City	State	Zip	Phone
UK, Khrih Thian	45 N Main St	Glen Ellyn	IL	60137	(331) 551-1193
SIANSIAM LLC.	4998 Battery Lane	Bethesda	MD	20814	(440) 391-6213
SHON, JASON	30 E Ridgewood Ave	Paramus	NJ	07652	(888) 280-4331
TUAN, Mung Khan	4673 Helia Ave	Las Cruces	NM	88012	(575) 650-8418
TUN, Zin Zin	11305 SW Harlod St.	Portland	OR	97266	(702) 292-5627
BIK, Duh	250 University Ave	California	PA	15419	(463) 701-6851
Pyae, Hsu Latt	6346 Chimney Wood Court	Alexandria	VA	22306	(571) 562-0138
MAXIDINA INC.	4554 Trailhead Dr.	Crozet	VA	22932	(703) 459-4775

If you buy this franchise, your contact information may be disclosed to other buyers when you leave the franchise system.

Wild Blue Food Service Counters
Ceased Operations
As of March 31, 2025

Name	Address	City	State	Zip	Phone
REH, Poe	217 Ward St FL 3	Hartford	CT	6106	(860) 322-7158
MIN CHO SUSHI CORPORATION	18861 Cloud Lake Cir	Boca Raton	FL	33496	(305) 761-6662
HANWOOREE INC.	809 Montague Dr	ST Johns	FL	32259	(904) 536-0317
SAN, San	200 Water Works Rd	Fort Thomas	KY	41075	(614) 603-7598
WANG, Ling	320 Washington St	North Easton	MA	02356	(508) 565-1000
WANG, Ling	1 Seymour St.	Quincy	MA	2169	(781) 888-8639
REH, Poe	577 Western Ave	Westfield	MA	01086	(413) 572-5300
GYATSO, Sherap	950 Main Street	Worcester	MA	01610	(508) 793-7711
GYATSO, Sherap	5300 Vernon Ave S, Apt 218	Edina	MN	55436	(646) 309-6005
LAL, Cung Uk	2157 Stanford Dr. SE	Grand Rapids	MN	49508	(616) 304-0243
TZT INC.	119 Gainsboro Rd	Lawrence Township	NJ	8648	(917) 553-2931
WAWN, Chang	33 Horseshoe Dr	Ephrata	PA	17522	(717) 208-9898
CHEFTK	2524 Teal Dr.	College Station	TX	77840	(402) 321-2168

If you buy this franchise, your contact information may be disclosed to other buyers when you leave the franchise system.

EXHIBIT N

LIST OF STATE ADMINISTRATORS AND AGENTS FOR SERVICE OF PROCESS

LIST OF STATE ADMINISTRATORS AND STATE AGENTS FOR SERVICE OF PROCESS

STATE	STATE ADMINISTRATOR	AGENT FOR SERVICE OF PROCESS
CALIFORNIA	Department of Financial Protection and Innovation 320 West 4 th Street, Suite 750 Los Angeles, California 90013 (213) 576-7500 (866) 275-2677 website:www.dfpi.ca.gov email: Ask.DFPI@dfpi.ca.gov	California, Commissioner of Financial Protection and Innovation 320 West 4 th Street, Suite 750 Los Angeles, California 90013 (213) 576-7500 (866) 275-2677 website:www.dfpi.ca.gov email: Ask.DFPI@dfpi.ca.gov
HAWAII	Business Registration Division Department of Commerce and Consumer Affairs 335 Merchant Street Room 203 Honolulu, Hawaii 96813 (808) 586-2722	Commissioner of Securities, Department of Commerce & Consumer Affairs 335 Merchant Street Room 203 Honolulu, Hawaii 96813 (808) 586-2722
ILLINOIS	Franchise Bureau Office of the Attorney General 500 South Second Street Springfield, Illinois 62706 (217) 782-4465	Franchise Bureau Office of the Attorney General 500 South Second Street Springfield, Illinois 62706 (217) 782-4465
INDIANA	Indiana Secretary of State Securities Division 302 West Washington Street, Room E-111 Indianapolis, Indiana 46204 (317) 232-6681	Indiana Secretary of State 201 State House 200 West Washington Street Indianapolis, Indiana 46204 (317) 232-6531
MARYLAND	Office of the Attorney General Securities Division 200 St. Paul Place Baltimore, Maryland 21202-2021 (410) 576-6360	Maryland Securities Commissioner Office of the Attorney General Securities Division 200 St. Paul Place Baltimore, Maryland 21202-2021 (410) 576-6360
MICHIGAN	Michigan Department of Attorney General Consumer Protection Attn: Franchise Section 525 West Ottawa Street G. Mennen Williams Building, 1 st Floor Lansing, Michigan 48933 (517) 335-7567	Michigan Department of Commerce Corporations and Securities Bureau P.O. Box 30054 6546 Mercantile Way Lansing, Michigan 48909 (517) 241-6345
MINNESOTA	Minnesota Department of Commerce 85 7 th Place East, Suite 280 St. Paul, Minnesota 55101-2198 (651) 539-1600	Commissioner of Commerce Minnesota Department of Commerce 85 7 th Place East, Suite 280 St. Paul, Minnesota 55101-2198 (651) 539-1600
NEBRASKA	Nebraska Department of Banking and Finance Bureau of Securities/Financial Institutions Division 1526 K Street, Suite 300 Lincoln, Nebraska 68508-2723 (402) 471-2171	Nebraska Department of Banking and Finance Bureau off Securities/Financial Institutions Division 1526 K Street, Suite 300 Lincoln, Nebraska 68508-2723 (402) 471-2171

STATE	STATE ADMINISTRATOR	AGENT FOR SERVICE OF PROCESS
NEW YORK	NYS Department of Law Investor Protection Bureau 28 Liberty Street, 21 st Fl New York, New York 10005 (212) 416-8285 (Phone) (212) 416-6042 (Fax)	New York Department of State One Commerce Plaza 99 Washington Avenue, 6 th Floor Albany, New York 12231-0001 (518) 473-2492
NORTH DAKOTA	North Dakota Securities Department 600 East Boulevard Avenue State Capitol Fifth Floor, Department 414 Bismarck, North Dakota 58505-0510 (701) 328-4712	North Dakota Securities Commissioner 600 East Boulevard Avenue State Capitol, Fifth Floor, Department 414 Bismarck, North Dakota 58505-0510 (701) 328-4712
RHODE ISLAND	Securities Division State of Rhode Island Department of Business Regulation, Bldg. 69, First Floor John O. Pastore Center 1511 Pontiac Avenue, Cranston, Rhode Island 02920 (401) 462-9582	Director, Securities Division Department of Business Regulation Bldg. 69, First Floor John O. Pastore Center 1511 Pontiac Avenue, Cranston, Rhode Island 02920 (401) 462-9582
SOUTH DAKOTA	Department of Labor and Regulation Division of Insurance Securities Regulation 124 South Euclid, Suite 104 Pierre, South Dakota 57501 (605) 773-3563	Director, Department of Labor and Regulation Division of Insurance Securities Regulation 124 South Euclid, Suite 104 Pierre, South Dakota 57501 (605) 773-3563
VIRGINIA	State Corporation Commission Division of Securities and Retail Franchising 1300 East Main Street, First Floor Richmond, Virginia 23219 (804) 371-9051	Clerk of the State Corporation Commission 1300 East Main Street, First Floor Richmond, Virginia 23219 (804) 371-9733
WASHINGTON	Securities Division Department of Financial Institutions P.O. Box 41200 Olympia, Washington 98504-1200 (360) 902-8760	Director, Department of Financial Institutions Securities Division 150 Israel Road S.W. Tumwater, Washington 98501 (360) 902-8760
WISCONSIN	Franchise Registration Division of Securities Wisconsin Department of Financial Institutions 201 West Washington Avenue, Suite 300 Madison, Wisconsin 53703 (608) 266-1064	Securities and Franchise Registration Wisconsin Securities Commission 201 West Washington Avenue, Suite 300 Madison, Wisconsin 53703 (608) 266-1064

EXHIBIT O

STATE SPECIFIC ADDENDA

STATE SPECIFIC DISCLOSURE REQUIREMENTS

The laws of several states require that we provide this Franchise Disclosure Document to you at the following earlier dates:

1. Iowa requires that we give you this disclosure document at the earlier of the first personal meeting or 14 calendar-days before the execution of the franchise or other agreement or the payment of any consideration that relates to the franchise relationship.

2. New York requires that we give you a copy of this Franchise Disclosure Document at the earlier of the first personal meeting or 10 business days before the execution of the franchise or other agreement or the payment of any consideration that relates to the franchise relationship.

3. Michigan requires that we give you this Franchise Disclosure Document at least 10 business days before the execution of any binding franchise or other agreement or the payment of any consideration, whichever occurs first.

For franchises that we sell for locations in CALIFORNIA, HAWAII, ILLINOIS, MARYLAND, MICHIGAN, MINNESOTA, NEW YORK, NORTH DAKOTA, RHODE ISLAND, VIRGINIA and WASHINGTON, applicable state law requires us to disclose additional information. Please refer to the separate state addendum pages in this Exhibit for the additional disclosures that may apply to you.

**ADDENDUM TO THE ADVANCED FRESH CONCEPTS FRANCHISE CORP.
FRANCHISE DISCLOSURE DOCUMENT - REQUIRED BY THE STATE OF CALIFORNIA**

The California Franchise Investment Law requires a copy of all proposed agreements relating to the sale of the franchise to be delivered together with the Franchise Disclosure Document 14 days prior to execution of any agreement.

Neither Advanced Fresh Concepts Franchise Corp, nor any person or franchise broker in item 2 of the Franchise Disclosure Document is subject to any currently effective order of any National Securities Association or National Securities Exchange, as defined in the Securities Exchange Act of 1934, 15 U.S.C.A. 78a et seq., suspending or expelling these persons from membership in this association or exchange.

You must sign a general release if you renew or transfer your franchise. California Corporations Code §31512 voids a waiver of your rights under the Franchise Investment Law (California Corporations Code §§31000 through 31516). Business and Professions Code §20010 voids a waiver of your rights under the Franchise Relations Act (Business and Professions Code §§20000 through 20043).

The California Business and Professions Code Sections 20000 through 20043 provide rights to the Franchisee concerning termination, transfer or non-renewal of a franchise. If the Franchise Agreement contains a provision that is inconsistent with the law, the law will control.

The Franchise Agreement provides for termination upon bankruptcy. This provision may not be enforceable under Federal Bankruptcy Law (11 U.S.C.A. sec. 101 et. seq.).

The Franchise Agreement contains a covenant not to compete which extends beyond the termination of the franchise. This provision may not be enforceable under California law.

The Franchise Agreement requires binding arbitration. The arbitration will occur in Los Angeles, California, according to the rules of the American Arbitration Association, with attorneys' fees being borne by the losing party.

Section 31125 of the Franchise Investment Law requires us to give to you a Disclosure Document approved by the Commissioner of Department of Financial Protection and Innovation before we ask you to consider a material modification of your Franchise Agreement.

Our website 'www.afcsushi.com' has not been reviewed or approved by the California Department of Financial Protection and Innovation. Any complaints concerning the contents of this website may be directed to the California Department of Financial Protection and Innovation at www.dfpi.ca.gov.

The Franchise Agreement contains a liquidated damages clause. Under California Civil Code Section 1671, certain liquidated damages are unenforceable.

No statement, questionnaire, or acknowledgement signed or agreed to by a franchisee in connection with the commencement of the franchise relationship shall have the effect of (i) waiving any claims under any applicable state franchise law, including fraud in the inducement, or (ii) disclaiming reliance on any statement made by any franchisor, franchise seller, or other person acting on behalf of franchisor. This provision supersedes any other term of any document executed in connection with the franchise.

California's Franchise Investment Law (Corporations Code sections 31512 and 31512.1):

Any provision of a franchise agreement or related document requiring the franchisee to waive specific provisions of the law is contrary to public policy and is void and unenforceable. The law also prohibits a

franchisor from disclaiming or denying (i) representations it, its employees, or its agents make to you, (ii) your ability to rely on any representations it makes to you, or (iii) any violations of the law.

You will not receive an exclusive territory. You may face competition from other franchisees, from outlets that we own, or from other channels of distribution or competitive brands that we control.

California enacted California Labor Code Sections 1474, 1475 and 1476, to provide for a state-wide increase in the minimum wage for fast food restaurant employees to \$20 per hour effective as of April 1, 2024, the creation of a Fast Food Council, and changes to employment standards in the fast-food restaurant industry. The new law applies to employees in national fast-food chains, which includes Zenshi Counters/AFC Food Service Counters/Wild Blue Counters.

The registration of this franchise does not constitute approval, recommendation, or endorsement by the commissioner of the California Department of Financial Protection and Innovation.

**ADDENDUM TO THE ADVANCED FRESH CONCEPTS FRANCHISE CORP.
FRANCHISE AGREEMENT – CALIFORNIA**

For the purposes of Cal. Bus. & Prof. Code Section 20022, Franchisor and Franchisee agree that:

1. The parties will use the declining-balance depreciation method to calculate the value of Franchisee's assets (inventory, supplies, equipment, fixtures, and furnishings) for the purposes of a purchase by Franchisor under Section 20022. The purchase price by Franchisor for these assets will not include the cost of removal and transportation of those assets, which will be Franchisee's responsibility.
2. For purposes of Section 20022, franchisee is not able to provide to Franchisor "clear title and possession" to Franchisee's assets if those assets are subject to liens or encumbrances including: (i) purchase money security interests; (ii) blanket security interests; (iii) rights of first refusal; (iv) liens by Franchisee's landlord; or (v) tax liens.
3. For the purposes of Section 20022(h), Franchisor's right of offset will include the following amounts owed by Franchisee to Franchisor or Franchisor's affiliates: (i) compensation to franchisor; (ii) marketing fund fees (if applicable); (iii) liquidated damages; (iv) transfer fees; and (v) any other type of fee or amounts owed by Franchisee to Franchisor or Franchisor's affiliates.

For the purposes of Cal. Bus. & Prof. Code Section 20035, Franchisor and Franchisee agree that:

1. **"Fair market value of the franchise assets"** means the value of Franchisee's assets, valued according to the declining-balance method of depreciation. The purchase price by franchisor for the assets will not include the cost of removal and transportation of those assets, which will be Franchisee's responsibility.
2. **"Fair market value of the franchised business"** means the **"fair market value of the franchise assets"** as defined above, plus goodwill. The parties agree that the value of goodwill is the amount of compensation to Franchisor paid by franchisee pursuant to the Franchise Agreement and any applicable addenda within the twelve (12) month period immediately before franchisor's termination or failure to renew if Franchisor is in violation of the California Franchise Relations Act.

No statement, questionnaire, or acknowledgement signed or agreed to by a franchisee in connection with the commencement of the franchise relationship shall have the effect of (i) waiving any claims under any applicable state franchise law, including fraud in the inducement, or (ii) disclaiming reliance on any statement made by any franchisor, franchise seller, or other person acting on behalf of franchisor. This provision supersedes any other term of any document executed in connection with the franchise.

California's Franchise Investment Law (Corporations Code sections 31512 and 31512.1):

Any provision of a franchise agreement or related document requiring the franchisee to waive specific provisions of the law is contrary to public policy and is void and unenforceable. The law also prohibits a franchisor from disclaiming or denying (i) representations it, its employees, or its agents make to you, (ii) your ability to rely on any representations it makes to you, or (iii) any violations of the law.

For the purposes of Cal. Code Regs. Tit. 10, § 310.114.1, Franchisor and Franchisee agree that:

- a. The California Franchise Investment Law requires a copy of all proposed agreements relating to the sale of the franchise to be delivered together with the Disclosure Document 14 days prior to execution of any agreement.

b. California Business and Professions Code Sections 20000 through 20043 provide rights to the franchisee concerning termination, transfer or non-renewal of a franchise. If the Franchise Agreement contains a provision that is inconsistent with the law, the law will control.

c. The Franchise Agreement provides for termination upon bankruptcy. This provision may not be enforceable under Federal Bankruptcy Law (11 U.S.C.A. sec. 101 et. Seq.).

d. The Franchise Agreement contains a covenant not to compete which extends beyond the termination of the franchise. This provision may not be enforceable under California law.

e. If the Franchise Agreement contains a liquidated damages clause. Under California Civil Code Section 1671, certain liquidated damages are unenforceable.

f. The Franchise Agreement requires the parties to resolve all disputes through arbitration in Los Angeles, California, with the costs being borne by the losing party.

Dated this ____ day of _____ 20__.

FRANCHISEE

Signature: _____

Print Name: _____

FRANCHISOR

ADVANCED FRESH CONCEPTS FRANCHISE CORP.

By: _____

Print Name: _____

DISCLOSURES REQUIRED BY HAWAII

THESE FRANCHISES WILL BE/HAVE BEEN FILED UNDER THE FRANCHISE INVESTMENT LAW OF THE STATE OF HAWAII. FILING DOES NOT CONSTITUTE APPROVAL, RECOMMENDATION OR ENDORSEMENT BY THE DIRECTOR OF COMMERCE AND CONSUMER AFFAIRS OR A FINDING BY THE DIRECTOR OF COMMERCE AND CONSUMER AFFAIRS THAT THE INFORMATION PROVIDED HEREIN IS TRUE, COMPLETE AND NOT MISLEADING.

THE FRANCHISE INVESTMENT LAW MAKES IT UNLAWFUL TO OFFER OR SELL A FRANCHISE IN THIS STATE WITHOUT FIRST PROVIDING THE PROSPECTIVE FRANCHISEE, OR SUBFRANCHISOR AT LEAST SEVEN DAYS PRIOR TO THE EXECUTION BY THE PROSPECTIVE FRANCHISEE OF ANY BINDING FRANCHISE OR OTHER AGREEMENT, OR AT LEAST SEVEN DAYS PRIOR TO THE PAYMENT OF ANY CONSIDERATION BY THE FRANCHISEE, OR SUBFRANCHISOR, WHICHEVER COMES FIRST, A COPY OF THE FRANCHISE DISCLOSURE DOCUMENT, TOGETHER WITH A COPY OF ALL PROPOSED AGREEMENTS RELATING TO THE SALE OF A FRANCHISE.

THIS FRANCHISE DISCLOSURE DOCUMENT CONTAINS A SUMMARY ONLY OF CERTAIN MATERIAL PROVISIONS OF THE FRANCHISE AGREEMENT. THE CONTRACT OR AGREEMENT SHOULD BE REFERRED TO FOR A STATEMENT OF ALL RIGHTS, CONDITIONS, RESTRICTIONS AND OBLIGATIONS OF BOTH THE FRANCHISOR AND THE FRANCHISEE.

NO STATEMENT, QUESTIONNAIRE, OR ACKNOWLEDGEMENT SIGNED OR AGREED TO BY A FRANCHISEE IN CONNECTION WITH THE COMMENCEMENT OF THE FRANCHISE RELATIONSHIP SHALL HAVE THE EFFECT OF (I) WAIVING ANY CLAIMS UNDER ANY APPLICABLE STATE FRANCHISE LAW, INCLUDING FRAUD IN THE INDUCEMENT, OR (II) DISCLAIMING RELIANCE ON ANY STATEMENT MADE BY ANY FRANCHISOR, FRANCHISE SELLER, OR OTHER PERSON ACTING ON BEHALF OF FRANCHISOR. THIS PROVISION SUPERSEDES ANY OTHER TERM OF ANY DOCUMENT EXECUTED IN CONNECTION WITH THE FRANCHISE.

**ADDENDUM TO THE ADVANCED FRESH CONCEPTS FRANCHISE CORP.
FRANCHISE DISCLOSURE DOCUMENT - REQUIRED BY THE STATE OF ILLINOIS**

By reading this disclosure document, you are not agreeing to, acknowledging, or making any representations whatsoever to the Franchisor and its affiliates.

Illinois law governs the agreements between the parties to this franchise.

Section 4 of the Illinois Franchise Disclosure Act provides that any provision in a franchise agreement that designates jurisdiction or venue outside the State of Illinois is void. However, a franchise agreement may provide for arbitration outside of Illinois.

Section 41 of the Illinois Franchise Disclosure Act provides that any condition, stipulation or provision purporting to bind any person acquiring any franchise to waive compliance with the Illinois Franchise Disclosure Act or any other law of Illinois is void.

Your rights upon termination and non-renewal of a franchise agreement are set forth in sections 19 and 20 of the Illinois Franchise Disclosure Act.

No statement, questionnaire, or acknowledgement signed or agreed to by a franchisee in connection with the commencement of the franchise relationship shall have the effect of (i) waiving any claims under any applicable state franchise law, including fraud in the inducement, or (ii) disclaiming reliance on any statement made by any franchisor, franchise seller, or other person acting on behalf of franchisor. This provision supersedes any other term of any document executed in connection with the franchise.

**ADDENDUM TO THE ADVANCED FRESH CONCEPTS FRANCHISE CORP.
FRANCHISE AGREEMENT - REQUIRED BY THE STATE OF ILLINOIS**

Illinois law governs the agreements between the parties to this franchise.

Section 4 of the Illinois Franchise Disclosure Act provides that any provision in a franchise agreement that designates jurisdiction or venue outside the State of Illinois is void. However, a franchise agreement may provide for arbitration outside of Illinois.

Section 41 of the Illinois Franchise Disclosure Act provides that any condition, stipulation or provision purporting to bind any person acquiring any franchise to waive compliance with the Illinois Franchise Disclosure Act or any other law of Illinois is void.

Your rights upon termination and non-renewal of a franchise agreement are set forth in sections 19 and 20 of the Illinois Franchise Disclosure Act.

No statement, questionnaire, or acknowledgement signed or agreed to by a franchisee in connection with the commencement of the franchise relationship shall have the effect of (i) waiving any claims under any applicable state franchise law, including fraud in the inducement, or (ii) disclaiming reliance on any statement made by any franchisor, franchise seller, or other person acting on behalf of franchisor. This provision supersedes any other term of any document executed in connection with the franchise.

Dated this ____ day of _____ 20__.

FRANCHISEE

FRANCHISOR

ADVANCED FRESH CONCEPTS
FRANCHISE CORP.

Signature: _____

By: _____

Print Name: _____

Print Name: _____

Title: _____

Title: _____

**ADDENDUM TO THE ADVANCED FRESH CONCEPTS FRANCHISE CORP.
FRANCHISE DISCLOSURE DOCUMENT - REQUIRED BY THE STATE OF MARYLAND**

The following is added to Items 1 and 12 of the Franchise Disclosure Document in Maryland:

Section 14-226 of the Maryland Franchise Registration and Disclosure Law prohibits us from requiring you to release or waive your rights as a condition of purchasing our franchise.

The following is added to Item 12 of the Franchise Disclosure Document in Maryland:

The general release required as a condition of relocation will not apply to any liability under the Maryland Franchise Registration and Disclosure Law, unless the relocation is part of an agreement between us to resolve an alleged registration and/or disclosure claim.

The following is added to Item 17(m) of the Franchise Disclosure Document in Maryland:

The general release required as a condition of transfer will not apply to any liability under the Maryland Franchise Registration and Disclosure Law, unless the transfer is part of an agreement between us to resolve an alleged registration and/or disclosure claim.

The following is added to Item 17(u) of the Franchise Disclosure Document in Maryland:

You may sue in Maryland for claims arising under the Maryland Franchise Registration and Disclosure Law, to the extent the dispute is neither pre-empted by the Federal Arbitration Act nor governed by the arbitration provisions of Section 16.8 of the Franchise Agreement. Any claims arising under the Maryland Franchise Registration and Disclosure Law must be brought within 3 years after the grant of the franchise.

The following is added to the Franchise Disclosure and Compliance Questionnaire:

The Franchise Disclosure and Compliance Questionnaire requires prospective franchisees to disclaim the occurrence and/or acknowledge the non-occurrence of acts that would constitute a violation of the Franchise Law. Such representations are not intended to nor shall they act as a release, estoppel or waiver of any liability incurred under the Maryland Franchise Registration and Disclosure Law.

No statement, questionnaire, or acknowledgment signed or agreed to by a franchisee in connection with the commencement of the franchise relationship shall have the effect of (i) waiving any claims under any applicable state franchise law, including fraud in the inducement, or (ii) disclaiming reliance on any statement made by any franchisor, franchise seller, or other person acting on behalf of the franchisor. This provision supersedes any other term of any document executed in connection with the franchise. Any questionnaire and specific Acknowledgments shall not apply to prospective franchisees who are Maryland residents or who seek to purchase a franchise located in Maryland.

**ADDENDUM TO THE ADVANCED FRESH CONCEPTS FRANCHISE CORP.
FRANCHISE AGREEMENT - REQUIRED BY THE STATE OF MARYLAND**

The following is added to Section 3.2 of the Franchise Agreement in Maryland:

The general release required as a condition of relocation shall not apply to any liability under the Maryland Franchise Registration and Disclosure Law, unless Franchisor's consent to the relocation is part of an agreement between Franchisee and Franchisor to resolve an alleged registration and/or disclosure claim.

The following is added to Section 14.9 of the Franchise Agreement in Maryland:

The general release required as a condition of transfer shall not apply to any liability under the Maryland Franchise Registration and Disclosure Law, unless Franchisor's consent to the transfer is part of an agreement between Franchisee and Franchisor to resolve an alleged registration and/or disclosure claim.

Section 16.14 is added to the Franchise Agreement in Maryland as follows:

Nothing in this Agreement is intended to or shall act as a release, estoppel or waiver of any liability incurred under the Maryland Franchise Registration and Disclosure Law.

The following is added to Section 16.8:

Franchisee may sue in Maryland for claims arising under the Maryland Franchise Registration and Disclosure Law, to the extent the dispute is neither pre-empted by the Federal Arbitration Act nor governed by the arbitration provisions of Section 16.8 of this Agreement. Any claims arising under the Maryland Franchise Registration and Disclosure Law must be brought within 3 years after the grant of the franchise.

No statement, questionnaire, or acknowledgment signed or agreed to by a franchisee in connection with the commencement of the franchise relationship shall have the effect of (i) waiving any claims under any applicable state franchise law, including fraud in the inducement, or (ii) disclaiming reliance on any statement made by any franchisor, franchise seller, or other person acting on behalf of the franchisor. This provision supersedes any other term of any document executed in connection with the franchise. Any questionnaire and specific Acknowledgments shall not apply to prospective franchisees who are Maryland residents or who seek to purchase a franchise located in Maryland.

(SIGNATURE PAGE FOLLOWS)

Dated this ____ day of _____ 20__.

FRANCHISEE

Signature: _____

Print Name: _____

Title: _____

FRANCHISOR

ADVANCED FRESH CONCEPTS
FRANCHISE CORP.

By: _____

Print Name: _____

Title: _____

**ADDENDUM TO THE FRANCHISE DISCLOSURE DOCUMENT PURSUANT TO
THE MICHIGAN FRANCHISE INVESTMENT LAW**

THE STATE OF MICHIGAN PROHIBITS CERTAIN UNFAIR PROVISIONS THAT ARE SOMETIMES IN FRANCHISE DOCUMENTS. IF ANY OF THE FOLLOWING PROVISIONS ARE IN THESE FRANCHISE DOCUMENTS, THE PROVISIONS ARE VOID AND CANNOT BE ENFORCED AGAINST YOU.

Each of the following provisions is void and unenforceable if contained in any documents relating to a Franchise:

- (a) A prohibition on the right of a Franchisee to join an association of Franchisees.
- (b) A requirement that a Franchisee assent to a release, assignment, novation, waiver, or estoppel which deprives a Franchisee of rights and protections provided in this act. This shall not preclude a Franchisee, after entering into a Franchise agreement from settling any and all claims.
- (c) A provision that permits a franchisor to terminate a Franchise prior to the expiration of its term except for good cause. Good cause shall include the failure of the Franchisee to comply with any lawful provision of the Franchise agreement and to cure such failure after being given written notice thereof and a reasonable opportunity, which in no event need be more than 30 days, to cure such failure.
- (d) A provision that permits a franchisor to refuse to renew a Franchise without fairly compensating the Franchisee by repurchase or other means for the fair market value at the time of expiration of the Franchisee's inventory, supplies, equipment, fixtures, and furnishings. Personalized materials which have no value to the franchisor and inventory, supplies, equipment, fixtures, and furnishing not reasonably required in the conduct of the Franchise business are not subject to compensation. This subsection applies only if: (i) the term of the Franchise is less than 5 years and (ii) the Franchisee is prohibited by the Franchise or other agreement from continuing to conduct substantially the same business under another trademark, service mark, trade name, logotype, advertising, or other commercial symbol in the same area subsequent to the expiration of the Franchise or the Franchisee does not receive at least 6 months advance notice of franchisor's intent not to renew the Franchise.
- (e) A provision that permits the franchisor to refuse to renew a Franchise on terms generally available to other Franchisees of the same class or type under similar circumstances. This section does not require a renewal provision.
- (f) A provision requiring that arbitration or litigation be conducted outside this state. This shall not preclude the Franchisee from entering into an agreement, at the time of arbitration, to conduct arbitration at a location outside this state.
- (g) A provision which permits a franchisor to refuse to permit a transfer of ownership of a Franchise, except for good cause. This subdivision does not prevent a franchisor from exercising a right of first refusal to purchase the Franchise. Good cause shall include, but is not limited to:
 - (i) The failure of the proposed transferee to meet the franchisor's then-current reasonable qualifications or standards.
 - (ii) The fact that the proposed transferee is a competitor of the franchisor or subfranchisor.
 - (iii) The unwillingness of the proposed transferee to agree in writing to comply with all lawful obligations.

- (iv) The failure of the Franchisee or proposed transferee to pay any sums owing to the franchisor or to cure any default in the Franchise agreement existing at the time of the proposed transfer.
- (h) A provision that requires the Franchisee to resell to the franchisor items that are not uniquely identified with the franchisor. This subdivision does not prohibit a provision that grants to a franchisor a right of first refusal to purchase the assets of a Franchise on the same terms and conditions as a bona fide third party willing and able to purchase those assets, nor does this subdivision prohibit a provision that grants the franchisor the right to acquire the assets of a Franchise for the market or appraised value of such assets if the Franchisee has breached the lawful provisions of the Franchise agreement and has failed to cure the breach in the manner provided in subdivision (c).
- (i) A provision which permits the franchisor to directly or indirectly convey, assign, or otherwise transfer its obligations to fulfill contractual obligations to the Franchisee unless provision has been made for providing the required contractual services.
- (j) No statement, questionnaire, or acknowledgement signed or agreed to by a franchisee in connection with the commencement of the franchise relationship shall have the effect of (i) waiving any claims under any applicable state franchise law, including fraud in the inducement, or (ii) disclaiming reliance on any statement made by any franchisor, franchise seller, or other person acting on behalf of franchisor. This provision supersedes any other term of any document executed in connection with the franchise.

THE FACT THAT THERE IS A NOTICE OF THIS OFFERING ON FILE WITH THE ATTORNEY GENERAL DOES NOT CONSTITUTE APPROVAL RECOMMENDATION, OR ENDORSEMENT BY THE ATTORNEY GENERAL.

Any questions regarding this notice should be directed to:

State of Michigan / Department of Attorney General
Consumer Protection Agency
Attention: Franchise
670 Law Building
525 West Ottawa Street
Lansing, Michigan 48913
Telephone Number: (517) 335-7567

**ADDENDUM TO THE ADVANCED FRESH CONCEPTS FRANCHISE CORP.
FRANCHISE DISCLOSURE DOCUMENT - REQUIRED BY THE STATE OF MINNESOTA**

THESE FRANCHISES HAVE BEEN FILED UNDER THE MINNESOTA FRANCHISE ACT. REGISTRATION DOES NOT CONSTITUTE APPROVAL, RECOMMENDATION OR ENDORSEMENT BY THE COMMISSIONER OF COMMERCE OF MINNESOTA OR A FINDING BY THE COMMISSIONER THAT THE INFORMATION PROVIDED HEREIN IS TRUE, COMPLETE AND NOT MISLEADING.

THE MINNESOTA FRANCHISE ACT MAKES IT UNLAWFUL TO OFFER OR SELL ANY FRANCHISE IN THIS STATE WHICH IS SUBJECT TO REGISTRATION WITHOUT FIRST PROVIDING THE PROSPECTIVE FRANCHISEE, AT LEAST SEVEN DAYS PRIOR TO THE EXECUTION BY THE PROSPECTIVE FRANCHISEE OF ANY BINDING FRANCHISE OR OTHER AGREEMENT, OR AT LEAST SEVEN DAYS PRIOR TO THE PAYMENT OF ANY CONSIDERATION BY THE FRANCHISEE, WHICHEVER COMES FIRST, A COPY OF THIS PUBLIC OFFERING STATEMENT, TOGETHER WITH A COPY OF ALL PROPOSED AGREEMENTS RELATING TO THE FRANCHISE.

THIS PUBLIC OFFERING STATEMENT CONTAINS A SUMMARY ONLY OF CERTAIN MATERIAL PROVISIONS OF THE FRANCHISE AGREEMENT. THE CONTRACT OR AGREEMENT SHOULD BE REFERRED TO FOR AN UNDERSTANDING OF ALL RIGHTS AND OBLIGATIONS OF BOTH THE FRANCHISOR AND THE FRANCHISEE.

The following is added to the Cover Page and Item 17 of the Franchise Disclosure Document in Minnesota:

Minn. Stat. §80C.21 and Minn. Rule 2860.4400J prohibits us from requiring litigation to be conducted outside Minnesota. In addition, nothing in the franchise disclosure document or agreement can abrogate or reduce any of your rights as provided for in Minnesota Statutes, Chapter 80C, or your rights to any procedure, forum, or remedies provided for by the laws of the jurisdiction.

The following is added to Item 13 the Franchise Disclosure Document in Minnesota:

With respect to franchises governed by Minnesota law, we will comply with Minn. Stat. Sec. 80C.12, Subd. 1(g), which requires us to protect your rights to use the trademarks, service marks, tradenames, logotypes or other commercial symbols or indemnify you from any loss, costs or expenses arising out of any claim, suit or demand regarding the use of the name.

The following is added to Item 17 Franchise Disclosure Document in Minnesota:

With respect to franchises governed by Minnesota law, we will comply with Minn. Stat. Sec. 80C.14, Subds. 3, 4, and 5 which require, except in certain specified cases, that you be given 90 days notice of termination (with 60 days to cure) and 180 days notice for non-renewal of the franchise agreement, and that our consent to the transfer of the franchise will not be unreasonably withheld.

The following is added to Item 17 of the Franchise Disclosure Document in Minnesota:

With respect to franchises governed by Minnesota law, we will comply with Minn. Rule 2860.4400J, which prohibits us from requiring you to waive any rights, including consent to injunctive relief. However, we may still seek injunctive relief.

The following is added to Item 17 of the Franchise Disclosure Document in Minnesota:

With respect to franchises governed by Minnesota law, we will comply with Minn. Rule 2860.4400D which prohibits us from requiring you to assent to a general release, except in connection with the voluntary settlement of disputes.

No statement, questionnaire, or acknowledgement signed or agreed to by a franchisee in connection with the commencement of the franchise relationship shall have the effect of (i) waiving any claims under any applicable state franchise law, including fraud in the inducement, or (ii) disclaiming reliance on any statement made by any franchisor, franchise seller, or other person acting on behalf of franchisor. This provision supersedes any other term of any document executed in connection with the franchise.

**ADDENDUM TO THE ADVANCED FRESH CONCEPTS FRANCHISE CORP.
FRANCHISE AGREEMENT - REQUIRED BY THE STATE OF MINNESOTA**

The following is added to Section 4.3 of the Franchise Agreement in Minnesota:

Franchisor will protect Franchisee’s rights to use the licensed trademarks, or indemnify Franchisee from any loss, costs or expenses arising out of any claim, suit or demand regarding the use of the licensed trademarks.

The following is added to Section 14.2 of the Franchise Agreement in Minnesota:

Consent to the transfer of the franchise will not be unreasonably withheld.

The following is added to Section 14.9 of the Franchise Agreement in Minnesota:

Franchisor will not require Franchisee to assent to a general release exceeding the limits permitted by Minn. Rule 2860.400D.

The following is added to Section 15.2 of the Franchise Agreement in Minnesota:

Except as and when otherwise permitted by law, Franchisee will be given 90 days notice of termination (with 60 days to cure) and except as and when otherwise permitted by law, 180 days notice for non-renewal of this agreement.

The following is added to Section 16.9 of the Franchise Agreement in Minnesota:

Franchisor will not require Franchisee to waive any rights, including consent to injunctive relief, exceeding the limits permitted by Minn. Rule 2860.4400J. However, Franchisor may still seek such relief.

No statement, questionnaire, or acknowledgement signed or agreed to by a franchisee in connection with the commencement of the franchise relationship shall have the effect of (i) waiving any claims under any applicable state franchise law, including fraud in the inducement, or (ii) disclaiming reliance on any statement made by any franchisor, franchise seller, or other person acting on behalf of franchisor. This provision supersedes any other term of any document executed in connection with the franchise.

Dated this ____ day of _____ 20__.

FRANCHISEE

FRANCHISOR

ADVANCED FRESH CONCEPTS
FRANCHISE CORP.

Signature: _____

By: _____

Print Name: _____

Print Name: _____

Title: _____

Title: _____

**ADDENDUM TO THE ADVANCED FRESH CONCEPTS FRANCHISE CORP.
FRANCHISE DISCLOSURE DOCUMENT - REQUIRED BY AND FOR THE
STATE OF NEW YORK**

1. The following information is added to the cover page of the Franchise Disclosure Document in New York:

INFORMATION COMPARING FRANCHISORS IS AVAILABLE. CALL THE STATE ADMINISTRATORS LISTED IN EXHIBIT N OR YOUR PUBLIC LIBRARY FOR SOURCES OF INFORMATION. REGISTRATION OF THIS FRANCHISE BY NEW YORK STATE DOES NOT MEAN THAT NEW YORK STATE RECOMMENDS IT OR HAS VERIFIED THE INFORMATION IN THIS FRANCHISE DISCLOSURE DOCUMENT. IF YOU LEARN THAT ANYTHING IN THE FRANCHISE DISCLOSURE DOCUMENT IS UNTRUE, CONTACT THE FEDERAL TRADE COMMISSION AND THE NEW YORK STATE DEPARTMENT OF LAW, BUREAU OF INVESTOR PROTECTION AND SECURITIES, 28 LIBERTY STREET, 21ST FLOOR, NEW YORK, NEW YORK 10005. THE FRANCHISOR MAY, IF IT CHOOSES, NEGOTIATE WITH YOU ABOUT ITEMS COVERED IN THE FRANCHISE DISCLOSURE DOCUMENT. HOWEVER, THE FRANCHISOR CANNOT USE THE NEGOTIATING PROCESS TO PREVAIL UPON A PROSPECTIVE FRANCHISEE TO ACCEPT TERMS WHICH ARE LESS FAVORABLE THAN THOSE SET FORTH IN THIS FRANCHISE DISCLOSURE DOCUMENT.

2. The following is added at the end of Item 3 of the Franchise Disclosure Document in New York:

Except as provided above, with regard to AFC, its predecessor, a person identified in Item 2, or an affiliate offering franchises under AFC's principal trademark:

A. No such party has an administrative, criminal or civil action pending against that person alleging: a felony; a violation of a franchise, antitrust, or securities law, fraud, embezzlement, fraudulent conversion, misappropriation of property; unfair or deceptive practices or comparable civil or misdemeanor allegations.

B. No such party has pending actions, other than routine litigation incidental to the business, which are significant in the context of the number of franchisees and the size, nature or financial condition of the franchise system or its business operations.

C. No such party has been convicted of a felony or pleaded nolo contendere to a felony charge or, within the 10-year period immediately preceding the application for registration, has been convicted of or pleaded nolo contendere to a misdemeanor charge or has been the subject of a civil action alleging: violation of a franchise, antifraud or securities law, fraud, embezzlement, fraudulent conversion or misappropriation of property, or unfair or deceptive practices or comparable allegations.

D. No such party is subject to a currently effective injunctive or restrictive order or decree relating to the franchise, or under a Federal, State or Canadian franchise, securities, antitrust, trade regulation or trade practice law, resulting from a concluded or pending action or proceeding brought by a public agency; or is subject to any currently effective order of any national securities association or national securities exchange, as defined in the Securities and Exchange Act of 1934, suspending or expelling such person from membership in such association or exchange; or is subject to a currently effective injunctive or restrictive order relating to any other business activity as a result of an action brought by a public agency or department, including, without limitation, actions affecting a license of as a real estate broker or sales agent.

3. The following is added to the end of Item 4 of the Franchise Disclosure Document in New York:

Neither AFC, its Affiliates, its Predecessors, officers, or general partner during the 10-year period immediately before the date of the disclosure document: (a) filed as debtor (or had filed against it) a petition to start an action under the U.S. Bankruptcy Code; (b) obtained a discharge of its debts under the bankruptcy code; or (c) was a principal officer of a company or a general partner in a partnership that either filed as a debtor (or had filed against it) a petition to start an action under the U.S. Bankruptcy Code or that obtained a discharge of its debts under the U.S. Bankruptcy Code during or within 1 year after the officer or general partner of the franchisor held this position in the company or partnership.

4. The following is added to the end of Item 5 of the Franchise Disclosure Document in New York:

The initial franchise fee constitutes part of our general operating funds and will be used as such in our discretion.

5. The following is added to the end of the “Summary” section of Item 17(c) titled “**Requirements for franchisee to renew or extend**,” and Item 17(m), entitled “**Conditions for AFC’s approval of transfer**”:

However, to the extent required by applicable law, all rights you enjoy and any causes of action arising in your favor from the provisions of Article 33 of the General Business Law of the State of New York and the regulations issued thereunder shall remain in force; it being the intent of this provision that the non-waiver provisions of the General Business Law Sections 687.4 and 687.5 be satisfied.

6. The following language replaces the “Summary” section of Item 17(d), titled “**Termination by you**” in New York:

You may terminate the agreement on any grounds available by law.

7. The following is added to the end of the “Summary” section of Item 17(j), titled “**Assignment of contract by AFC**” in New York:

However, no assignment will be made except to an assignee who in the good faith and judgment of AFC, is willing and financially able to assume AFC’s obligations under the Franchise Agreement.

8. The following is added to the end of the “Summary” sections of Item 17(v), titled “**Choice of forum**”, and Item 17(w), titled “**Choice of law**”:

The foregoing choice of law should not be considered a waiver of any right conferred upon AFC or upon the franchisee by Article 33 of the General Business Law of the State of New York.

9. No statement, questionnaire, or acknowledgement signed or agreed to by a franchisee in connection with the commencement of the franchise relationship shall have the effect of (i) waiving any claims under any applicable state franchise law, including fraud in the inducement, or (ii) disclaiming reliance on any statement made by any franchisor, franchise seller, or other person acting on behalf of franchisor. This provision supersedes any other term of any document executed in connection with the franchise.

**ADDENDUM TO THE ADVANCED FRESH CONCEPTS FRANCHISE CORP.
FRANCHISE DISCLOSURE DOCUMENT - REQUIRED BY THE STATE OF NORTH DAKOTA**

Item 17(i) of the Franchise Disclosure Document is revised in North Dakota to delete the provision requiring you to pay our expenses in the event of your breach or default.

The following is added to Item 17(r) of the Franchise Disclosure Document in North Dakota:

Covenants not to compete such as those mentioned above are generally considered unenforceable in the State of North Dakota.

Item 17(u) of the Franchise Disclosure Document is revised in North Dakota to allow the site of arbitration to be as agreeable to all parties.

The provisions contained in Item 17(v) of the Franchise Disclosure Document are deleted in North Dakota.

The provisions contained in Item 17(w) of the Franchise Disclosure Document are deleted in North Dakota.

No statement, questionnaire, or acknowledgement signed or agreed to by a franchisee in connection with the commencement of the franchise relationship shall have the effect of (i) waiving any claims under any applicable state franchise law, including fraud in the inducement, or (ii) disclaiming reliance on any statement made by any franchisor, franchise seller, or other person acting on behalf of franchisor. This provision supersedes any other term of any document executed in connection with the franchise.

**ADDENDUM TO THE ADVANCED FRESH CONCEPTS FRANCHISE CORP.
FRANCHISE AGREEMENT - REQUIRED BY THE STATE OF NORTH DAKOTA**

If Franchisee's location is in North Dakota, then Section 15.6(E) of the Franchise Agreement is deleted.

If Franchisee's location is in North Dakota, then Section 6 of the Franchise Agreement will be interpreted in accordance with Section 9-08-06 of the North Dakota Century Code.

If Franchisee's location is in North Dakota then Sections 16.7 of the Franchise Agreement is deleted.

If Franchisee's location is in North Dakota then Section 16.8(D) of the Franchise Agreement is revised to provide that the site of arbitration shall be agreeable to all parties.

No statement, questionnaire, or acknowledgement signed or agreed to by a franchisee in connection with the commencement of the franchise relationship shall have the effect of (i) waiving any claims under any applicable state franchise law, including fraud in the inducement, or (ii) disclaiming reliance on any statement made by any franchisor, franchise seller, or other person acting on behalf of franchisor. This provision supersedes any other term of any document executed in connection with the franchise.

Dated this ____ day of _____ 20__.

FRANCHISEE

FRANCHISOR

ADVANCED FRESH CONCEPTS
FRANCHISE CORP.

Signature: _____

By: _____

Print Name: _____

Print Name: _____

Title: _____

Title: _____

DISCLOSURES REQUIRED BY RHODE ISLAND

Under Section 19-28.1-14 of the Rhode Island Franchise investment Act, a provision in a Franchise Agreement restricting jurisdiction or venue to a forum outside of Rhode Island or requiring the application of the laws of another state is void with respect to an otherwise enforceable claim that is not subject to binding arbitration.

No statement, questionnaire, or acknowledgement signed or agreed to by a franchisee in connection with the commencement of the franchise relationship shall have the effect of (i) waiving any claims under any applicable state franchise law, including fraud in the inducement, or (ii) disclaiming reliance on any statement made by any franchisor, franchise seller, or other person acting on behalf of franchisor. This provision supersedes any other term of any document executed in connection with the franchise.

**ADDENDUM TO THE ADVANCED FRESH CONCEPTS FRANCHISE CORP.
FRANCHISE AGREEMENT - REQUIRED BY THE STATE OF RHODE ISLAND**

If Franchisee's location is in Rhode Island, then the parties agree that to the extent that any provision in any of the agreements entered into by the parties are inconsistent with the Rhode Island Franchise Investment Act, the provisions of the Act shall control. The parties furthermore expressly agree that Rhode Island law shall be applied to, and govern, any claim between the parties that alleges violation of the Act.

No statement, questionnaire, or acknowledgement signed or agreed to by a franchisee in connection with the commencement of the franchise relationship shall have the effect of (i) waiving any claims under any applicable state franchise law, including fraud in the inducement, or (ii) disclaiming reliance on any statement made by any franchisor, franchise seller, or other person acting on behalf of franchisor. This provision supersedes any other term of any document executed in connection with the franchise.

Dated this ____ day of _____ 20__.

FRANCHISEE

FRANCHISOR

ADVANCED FRESH CONCEPTS
FRANCHISE CORP.

Signature: _____

By:: _____

Print Name: _____

Print Name: _____

Title: _____

Title: _____

DISCLOSURES REQUIRED BY VIRGINIA

Item 17 is amended by the addition of the following:

“According to Section 13.1-564 of the Virginia Retail Franchising Act, it is unlawful for a franchisor to cancel a franchise without reasonable cause. If any grounds for default or termination stated in the Franchise Agreement does not constitute “reasonable cause,” as that term may be defined in the Virginia Retail Franchising Act or the laws of Virginia, that provision may not be enforceable.”

No statement, questionnaire, or acknowledgement signed or agreed to by a franchisee in connection with the commencement of the franchise relationship shall have the effect of (i) waiving any claims under any applicable state franchise law, including fraud in the inducement, or (ii) disclaiming reliance on any statement made by any franchisor, franchise seller, or other person acting on behalf of franchisor. This provision supersedes any other term of any document executed in connection with the franchise.

WASHINGTON
ADDENDUM TO DISCLOSURE DOCUMENT, FRANCHISE AGREEMENT AND RELATED AGREEMENTS

The provisions of this Addendum form an integral part of, are incorporated into, and modify the Franchise Disclosure Document, the Franchise Agreement and all related agreements regardless of anything to the contrary contained therein. This Addendum applies if: (a) the offer to sell a franchise is accepted in Washington; (b) the purchaser of the franchise is a resident of Washington; and/or (c) the franchised business that is the subject of the sale is to be located or operated, wholly or partly, in Washington.

1. **Conflict of Laws.** In the event of a conflict of laws, the provisions of the Washington Franchise Investment Protection Act, Chapter 19.100 RCW (the “Act”) will prevail.
2. **Franchisee Bill of Rights.** The State of Washington has a statute, the Act, which might supersede this Agreement in your relationship with us, including the areas of termination and renewal of your franchise. There might also be court decisions which supersede the Agreement in your relationship with us, including termination and renewal of your franchise. Franchise Agreement provisions, including those summarized in Item 17 of the Franchise Disclosure Document, are subject to state law.
3. **Site of Arbitration, Mediation, and/or Litigation.** In any arbitration or mediation involving a franchise purchased in Washington, the arbitration or mediation site will be either in the State of Washington, or in a place mutually agreed upon at the time of the arbitration or mediation, or as determined by the arbitrator or mediator at the time of arbitration or mediation. In addition, if litigation is not precluded by the Franchise Agreement, a Franchisee may bring an action or proceeding arising out of or in connection with the sale of franchises, or a violation of the Washington Franchise Investment Protection Act, in Washington.
4. **General Release.** A release or waiver of rights in the Franchise Agreement or related agreements purporting to bind you to waive compliance with any provisions under the Act or any rules or orders thereunder is void, except when executed pursuant to a negotiated settlement after the Agreement is in effect and where the parties are represented by independent counsel, in accordance with the Act. In addition, any such release or waiver executed in connection with a renewal or transfer of a franchise is likewise void, except as provided for in the Act.
5. **Statute of Limitations and Waiver of Jury Trial.** Provisions contained in the Franchise Agreement or related agreements that unreasonably restrict or limit the statute of limitations period for claims under the Act, or rights or remedies under the Act, such as a right to a jury trial, might not be enforceable.
6. **Transfer Fees.** Transfer fees are collectable to the extent that they reflect our reasonable estimate or actual costs in effecting a transfer.
7. **Termination by Franchisee.** You may terminate the Franchise Agreement under any ground permitted under state law.
8. **Certain Buy-Back Provisions.** Provisions in Franchise Agreements or related agreements that permit the Franchisor to repurchase the Franchisee’s business for any reason during the term of the Franchise Agreement without the Franchisee’s consent are unlawful pursuant to RCW 19.100.180(2)(j), unless the franchise is terminated for good cause.
9. **Fair and Reasonable Pricing.** Any provision in the Franchise Agreements or related agreements that requires the Franchisee to purchase or rent any product or service for more than a fair and reasonable price is unlawful under RCW 19.100.180(2)(d).

10. **Waiver of Exemplary & Punitive Damages.** RCW 19.100.190 permits Franchisees to seek treble damages under certain circumstances. Accordingly, provisions contained in the Franchise Agreement or elsewhere requiring Franchisees to waive exemplary, punitive, or similar damages are void, except when executed pursuant to a negotiated settlement after the agreement is in effect and where the parties are represented by independent counsel, in accordance with RCW 19.100.220(2).

11. **Franchisor's Business Judgement.** Provisions in the Franchise Agreement or related agreements stating that the Franchisor may exercise its discretion on the basis of its reasonable business judgment may be limited or superseded by RCW 19.100.180(1), which requires the parties to deal with each other in good faith.

12. **Indemnification.** Any provision in the Franchise Agreement or related agreements requiring the Franchisee to indemnify, reimburse, defend, or hold harmless the Franchisor or other parties is hereby modified such that the Franchisee has no obligation to indemnify, reimburse, defend, or hold harmless the Franchisor or any other indemnified party for losses or liabilities to the extent that they are caused by the indemnified party's negligence, willful misconduct, strict liability, or fraud.

13. **Attorneys' Fees.** If the Franchise Agreement or related agreements require a Franchisee to reimburse the Franchisor for court costs or expenses, including attorneys' fees, such provision applies only if the Franchisor is the prevailing party in any judicial or arbitration proceeding.

14. **Noncompetition Covenants.** Pursuant to RCW 49.62.020, a noncompetition covenant is void and unenforceable against an employee, including an employee of a Franchisee, unless the employee's earnings from the party seeking enforcement, when annualized, exceed \$100,000 per year (an amount that will be adjusted annually for inflation). In addition, a noncompetition covenant is void and unenforceable against an independent contractor of a Franchisee under RCW 49.62.030 unless the independent contractor's earnings from the party seeking enforcement, when annualized, exceed \$250,000 per year (an amount that will be adjusted annually for inflation). As a result, any provisions contained in the Franchise Agreement or elsewhere that conflict with these limitations are void and unenforceable in Washington.

15. **Nonsolicitation Agreements.** RCW 49.62.060 prohibits a Franchisor from restricting, restraining, or prohibiting a franchisee from (i) soliciting or hiring any employee of a franchisee of the same Franchisor or (ii) soliciting or hiring any employee of the Franchisor. As a result, any such provisions contained in the Franchise Agreement or elsewhere are void and unenforceable in Washington.

16. **Questionnaires and Acknowledgments.** No statement, questionnaire, or acknowledgement signed or agreed to by a Franchisee in connection with the commencement of the franchise relationship shall have the effect of (i) waiving any claims under any applicable state franchise law, including fraud in the inducement, or (ii) disclaiming reliance on any statement made by any Franchisor, franchise seller, or other person acting on behalf of Franchisor. This provision supersedes any other term of any document executed in connection with the franchise.

17. **Prohibitions on Communicating with Regulators.** Any provision in the Franchise Agreement or related agreements that prohibits the Franchisee from communicating with or complaining to regulators is inconsistent with the express instructions in the Franchise Disclosure Document and is unlawful under RCW 19.100.180(2)(h).

18. **Advisory Regarding Franchise Brokers.** Under the Act, a "franchise broker" is defined as a person that engages in the business of the offer or sale of franchises. A franchise broker represents the Franchisor and is paid a fee for referring prospects to the Franchisor and/or selling the franchise. If a Franchisee is working with a franchise broker, Franchisees are advised to carefully evaluate any information provided by the franchise broker about a franchise.

18. **Advisory Regarding Franchise Brokers.** Under the Act, a “franchise broker” is defined as a person that engages in the business of the offer or sale of franchises. A franchise broker represents the Franchisor and is paid a fee for referring prospects to the Franchisor and/or selling the franchise. If a Franchisee is working with a franchise broker, Franchisees are advised to carefully evaluate any information provided by the franchise broker about a franchise.

19. The following sentence is added to Item 1 of the Franchise Disclosure Document:

For Washington residents and for locations in the state of Washington, following your request, we will allow you to view an unredacted version of the underlying agreement with the venue where your Food Service Counter will be located. Following your request, we will provide you with a copy of the underlying agreement with the venue where your Food Service Counter is or will be located, subject to redaction of confidential provisions negotiated with the venue. Provisions subject to redaction include the percentage of rent payable to other facilities covered by the agreement, payment methods, payment terms, term of the agreement, and Exhibit A, which lists locations covered by the agreement not relevant to your proposed operations.

20. The following sentence is added to Item 1 of the Franchise Disclosure Document:

For locations outside Washington, we offer franchisees the opportunity to operate Food Service Counters under the trademarks "Southern Tsunami" and "Hybrid Sushi". We do not offer this opportunity to Washington residents or for locations in the state of Washington. Accordingly, you will not be able to use these marks at your locations.

21. The following sentence is added to Item 6, Note 4 of the Franchise Disclosure Document and Section 9.3 of the Franchise Agreement:

“For Washington residents and for locations in the state of Washington, we will never retain more than 11% of the amounts collected on account of your operations (plus any amounts you owe us) and you will never receive less than 62% of the amounts collected from your operations (adjusted for any amounts you owe us).”

22. For Washington residents and for locations in the state of Washington, the following sentence is deleted in Section 3.2 of the Franchise Agreement:

“Franchisee releases Franchisor and its affiliates, and each of their respective officers, directors, agents and employees from any loss of right or consent to operate at the location, and further agrees not to hold Franchisor liable for any such event during the term of this Agreement or thereafter”.

23. Section 16.13 of the Franchise Agreement is deleted in its entirety.

24. In Re Assurance of Discontinuance (“AOD”):

For many years AFC franchise agreements said a franchisee must not hire employees of AFC or of other AFC franchisees. Generally, this was Section 6.7 of the Franchise Agreement. Previously, this clause was never challenged.

The Attorney General of Washington State claimed our provision was a restraint of trade and demanded that AFC not enforce the provision. AFC denied the Attorney General’s claim. Because we and our franchisees are all one brand, we believed our steps were lawful and pro-competitive.

In June 2019, before we were contacted by Washington State, AFC preemptively removed the no-poach provision from our standard Franchise Agreement, and decided we will not enforce and will not require franchisees to comply with it. On November 15, 2019, without admitting liability and solely to avoid protracted and expensive litigation with the Washington Attorney General (AG), AFC entered into an agreement with Washington State. Under the agreement, AFC agreed: (1) not to include no-poach provisions in future franchise agreements for locations in the United States; (2) not to enforce no-poach provisions in our existing U.S. franchise agreements and not seek to intervene in any action brought by the Washington AG to defend the legality of the no-poach provision; (3) to notify all U.S. franchisees of AFC's agreement with the Washington AG and to provide them a copy of the AOD on request; (4) to notify the Washington AG if we learn of any effort by a Washington franchisee to enforce an existing no-poach agreement; (5) within 90 days of the entry of the AOD to endeavor to amend all existing franchise agreements in Washington to remove the no-poach provision and to provide the Washington AG the name and address of franchisees who decline our offer to amend the franchise agreement; (6) as they come up for renewal or renegotiation, to amend existing U.S. franchise agreements to remove the no-poach provision; and (7) within 30 days of the conclusion of the above time periods to notify the AG's office of our compliance.

The AOD we entered into was a voluntary settlement and was not an admission of law, fact, liability, misconduct or wrongdoing on AFC's part.

The undersigned does hereby acknowledge receipt of this addendum.

Dated this _____ day of _____ 20____.

FRANCHISEE

FRANCHISOR

ADVANCED FRESH CONCEPTS FRANCHISE CORP.

Signature: _____

By: _____

Print Name: _____

Print Name: _____

Title: _____

Title: _____

EXHIBIT P

CONFIDENTIALITY AGREEMENT

CONFIDENTIALITY AGREEMENT

This Confidentiality Agreement (this "Agreement") is made and entered into on _____, 20__ between Advanced Fresh Concepts Franchise Corp. a California corporation ("Franchisor") with an address of 19700 Mariner Avenue Torrance, California 90503, on the one hand, and _____, a _____ ("Candidate") with an address of _____, on the other hand, with reference to the following facts:

A. Franchisor has developed the "AFC System" for the establishment and operation of one or more Zenshi Counter(s), AFC Food Service Counter(s), and Wild Blue Counter(s) in grocery stores, retail stores and other locations ("Food Service Counters") that offer prepared sushi and other Asian style foods under the trade names and service marks "Zenshi," "Advanced Fresh," the oval AFC logo, "Wild Blue," "Hybrid Sushi," "Southern Tsunami," the Southern Tsunami logo and other related trademarks, service marks, logos and commercial symbols, and the trade dress used to identify the Food Service Counters (collectively, the "AFC Marks"). The "AFC System" means the unique system developed by Franchisor that includes operating methods and business practices related to Food Service Counters, the relationship between Franchisor and its franchisees, Food Service Counter design, other items of trade dress, specifications for equipment, fixtures and uniforms, defined product offerings, recipes and preparation methods, Franchisor specified pricing and promotions, restrictions on ownership, standard operating and administrative procedures, management and technical training programs, marketing and public relations programs, and Franchisor's website, all as Franchisor may modify from time to time.

B. Franchisor has the right to use, and to license others to use, the AFC Marks and the AFC System, and has, as a result of its expenditure of time, skill, effort, and money, developed a distinctive franchise model for qualified franchisees to obtain the right to operate a Food Service Counter using the AFC Marks and the AFC System.

C. Franchisor may provide Candidate with confidential, proprietary and/or trade secret information regarding the AFC System prior to granting or declining to grant Candidate a franchise or entering into a Franchise Agreement with Candidate. Franchisor desires that Candidate maintain the confidentiality of all such confidential, proprietary and/or trade secret information on the terms and conditions set forth in this Agreement.

NOW, THEREFORE, IT IS AGREED:

1. INCORPORATION OF RECITALS.

The recitals set forth in Paragraphs A through Paragraph C above are true and correct and are hereby incorporated by reference into the body of this Agreement.

2. CONFIDENTIALITY.

Candidate acknowledges and agrees that:

2.1. **Confidential Information.** Candidate's knowledge of the elements of the AFC System and any other proprietary data that may be disclosed to Candidate by Franchisor, or any affiliate of Franchisor, including, without limitation, any and all confidential and/or proprietary knowledge, data or information of Franchisor and any and all confidential and/or proprietary knowledge, data or information which Candidate has obtained or obtains from Franchisor which Franchisor treats as proprietary or designates (whether or not in writing or electronic form) as confidential shall constitute "Confidential Information". By way of illustration, but not limitation, "Confidential Information" includes tangible and intangible information (whether or not in electronic form) relating to Franchisor's business operations, styles, products and services, recipes, sources of materials and equipment, client management and other software, data, other content, formulations, patterns, compilations, programs, devices and processes, business relationships, contact information for industry professionals, developmental or experimental work and services, improvements, discoveries, plans for research, potential new or supplemental products and services,

websites, advertisements or ancillary products and services, marketing and selling methods and/or plans, business plans, budgets and unpublished financial statements, licenses, prices and costs, vendors, collaborators, current customer and prospective customer names and addresses, information on Franchisor, Franchisor's arrangements and contracts with the facility owners where the Food Service Counters are located, information regarding credit extensions to customers, customer service purchasing histories and prices charged to customers, customer lists and other customer data, information regarding the skills and compensation of employees and contractors of Franchisor, designs, drawings, specifications, source code, object code, documentation, diagrams, flowcharts, research, development, marketing techniques and materials, trademarks, trade secrets, sales/license techniques, inventions, copyrightable material, trademarkable material, databases, relationships between Franchisor and other companies, persons or entities, the AFC System, and any other information or material considered proprietary by Franchisor whether or not designated as confidential information by Franchisor, that is not generally known by the public, or which derives independent economic value (actual or potential) from not being generally known to the public or persons unaffiliated with Franchisor or its affiliates and which is the subject of efforts by Franchisor that are reasonable under the circumstances to maintain its secrecy, and any other information in oral, written, graphic or electronic form which, given the circumstances surrounding its disclosure, would be considered confidential. Confidential Information also includes the manner in which any of the above described items may be combined with any other information or products or synthesized or used by Candidate. Confidential Information does not include any information that was in the lawful and unrestricted possession of Candidate prior to its disclosure by Franchisor; is or becomes generally available to the public by acts other than those of Candidate after receiving it; has been received lawfully and in good faith by Candidate from a third party who did not derive it from Franchisor or Candidate; or is shown by acceptable evidence to have been independently developed by Candidate.

2.2. **Value**. The Confidential Information has been developed by Franchisor, and its parent company and affiliate by the investment of time, skill, effort and money and is widely recognized by the public and is of substantial value.

2.3. **Proprietary**. The Confidential Information is proprietary, confidential and constitutes a trade secret of Franchisor and its affiliates.

2.4. **Maintain Confidentiality**. Candidate will fully and strictly maintain the confidentiality of the Confidential Information, will exercise the highest degree of diligence in safeguarding the Confidential Information and will not disclose or reveal the Confidential Information to any person other than another person who is actively and directly participating in the acquisition of the franchise with Candidate, but only after first disclosing the identity of such person to Franchisor in writing and obtaining such person's signature on a Non-Disclosure Agreement similar to this Agreement, unless covered by attorney-client privilege.

2.5. **Reproduction and Use**. Candidate will not directly or indirectly reproduce or copy any Confidential Information or any part thereof and will make no use of any Confidential Information for any purpose whatsoever unless and until Candidate becomes a franchisee of Franchisor, and then only in accordance with the provisions of Candidate's Franchise Agreement.

2.6 **No Prior Experience**. Candidate specifically acknowledges and agrees that prior to the execution of this Agreement, Candidate had no experience, information or knowledge whatsoever about Food Service Counters or restaurants that serve or offer prepared sushi and other Asian style foods and that Candidate's knowledge of the Confidential Information was obtained solely from Franchisor pursuant to this Agreement. In addition, Candidate specifically acknowledges that, pursuant to this Agreement, Candidate will receive valuable Confidential Information regarding the operational, sales, promotional, and marketing methods and techniques of Franchisor and the AFC System, which are unique and proprietary to Franchisor, derive independent economic value from not being generally known to the public and are the subject of Franchisor's efforts and that are reasonable under the circumstances to maintain their secrecy.

3. **GENERAL.**

3.1. **Injunction.** Candidate recognizes the unique value and secondary meaning attached to the Confidential Information and the elements of the AFC System and agrees that any noncompliance with the terms of this Agreement or any unauthorized or improper use of the Confidential Information will cause irreparable damage to Franchisor and its franchisees. Candidate therefore agrees that if Candidate should engage in any such unauthorized or improper use of the Confidential Information, Franchisor shall be entitled to both permanent and temporary injunctive relief from any court of competent jurisdiction without notice or the posting of any bond, in addition to any other remedies prescribed by law.

3.2. **Heirs and Successors.** This Agreement shall be binding upon and inure to the benefit of the parties, their heirs, successors and assigns.

3.3. **Entire Agreement.** This Agreement represents the entire understanding between the parties regarding the subject matter of this Agreement and supersedes all other negotiations, agreements, representations and covenants, oral or written. This Agreement may not be modified except by a written instrument signed by Franchisor and Candidate that expressly modifies this Agreement. The parties intend this Agreement to be the entire integration of all of their agreements regarding the subject matter of this Agreement. No other agreements, representations, promises, commitments or the like, of any nature, exist between the parties.

3.4. **No Right to Use the AFC System or the AFC Marks.** This Agreement is not a Franchise Agreement or a license of any sort, and does not grant Candidate any right to use or to franchise or license the use of, the Confidential Information, which right is expressly reserved by Franchisor.

3.5. **Waiver.** Failure by Franchisor to enforce any rights under this Agreement shall not be construed as a waiver of such rights. Any waiver, including a waiver of default, in any one instance shall not constitute a continuing waiver or a waiver in any other instance.

3.6. **Validity.** Any invalidity of any portion of this Agreement shall not affect the validity of the remaining portions and unless substantial performance of this Agreement is frustrated by any such invalidity, this Agreement shall continue in full force and effect.

3.7. **Headings and Gender.** The headings herein are for purposes of convenience only and shall not be used in construing the provisions hereof. As used herein, the male gender shall include the female and neuter genders, the singular shall include the plural and the plural, the singular.

3.8. **Attorneys' Fees.** If Franchisor becomes a party to any legal proceedings concerning this Agreement by reason of any act or omission of Candidate or its authorized representatives, Candidate shall be liable to Franchisor for the reasonable attorneys' fees and court costs incurred by Franchisor in the legal proceedings. If either party commences a legal proceeding against the other party arising out of or in connection with this Agreement, the prevailing party shall be entitled to have and recover from the other party its reasonable attorneys' fees and costs of suit.

3.9. **Cumulative Remedies.** Any specific right or remedy set forth in this Agreement, legal, equitable, or otherwise, shall not be exclusive, but shall be cumulative with all other rights or remedies set forth herein or allowed or allowable by law.

3.10. **Notices.** Except as otherwise stated in this Agreement, all notices which are required by this Agreement shall be deemed to be delivered 3 days after being placed in the U.S. Mail, certified mail, return receipt requested or priority mail with delivery receipt confirmation, or one day after being sent by United Parcel Service or other receipted overnight courier service if addressed to a party at the address stated in the introductory paragraph of this Agreement, or other address of which a party has given notice to the other, or immediately by hand delivery to a party. Franchisee shall

provide Franchisor Franchisee's physical address for notice purposes under this Section and shall keep Franchisor updated of any changes thereto.

3.11. **Governing Law.** This Agreement takes effect upon its acceptance and execution by Franchisor in California, and shall be interpreted and construed under the laws of California.

3.12. **Venue.** The parties agree that any action brought by either party against the other in any court, whether federal or state, shall be brought within the city and county in which Franchisor has its principal place of business at the time the action is initiated, and the parties hereby waive all questions of personal jurisdiction or venue for the purpose of carrying out this provision.

3.13. **Counterparts and Electronic Transmission; Electronic Signatures.** This Agreement may be executed in any number of counterparts, each of which shall be deemed to be an original and all of which together shall be deemed to be one and the same instrument. Copies of this Agreement with signatures that have been transmitted by email or by facsimile shall constitute and be deemed original copies of this Agreement for all purposes, provided that the copies are fully executed, dated and identical in form to the original hard copy version of this Agreement. In addition, this Agreement may be signed electronically by the Parties and electronic signatures appearing on this Agreement shall be deemed to be the same as handwritten signatures for the purposes of the validity, enforceability and admissibility of this Agreement.

IN WITNESS WHEREOF, the parties have executed this Agreement as of the Effective Date.

FRANCHISOR:

CANDIDATE:

ADVANCED FRESH CONCEPTS FRANCHISE CORP.,
A California corporation

By: _____
Name: _____
Title: _____

By: _____
Name: _____
Title: _____

EXHIBIT Q

**TABLET AND RICE SHEETER
SPECIFICATIONS**

Appendix

Samsung Tablet A7 Lite



NETWORK	<u>Technology</u>	<u>GSM / HSPA / LTE</u>
LAUNCH	<u>Announced</u>	2021, May 27
	<u>Status</u>	Available. Released 2021, June 18
BODY	<u>Dimensions</u>	212.5 x 124.7 x 8 mm (8.37 x 4.91 x 0.31 in)
	<u>Weight</u>	366 g (Wi-Fi), 371 g (LTE) (12.91 oz)
	<u>Build</u>	Glass front, aluminum back, aluminum frame, plastic ends
	<u>SIM</u>	Nano-SIM
DISPLAY	<u>Type</u>	TFT
	<u>Size</u>	8.7 inches, 214.9 cm ² (~81.1% screen-to-body ratio)
	<u>Resolution</u>	800 x 1340 pixels, 5:3 ratio (~179 ppi density)
PLATFORM	<u>OS</u>	Android 11, One UI 3.1
	<u>Chipset</u>	Mediatek MT8768T Helio P22T (12 nm)
	<u>CPU</u>	Octa-core (4x2.3 GHz Cortex-A53 & 4x1.8 GHz Cortex-A53)
	<u>GPU</u>	PowerVR GE8320
MEMORY	<u>Card slot</u>	microSDXC (dedicated slot)
	<u>Internal</u>	32GB 3GB RAM, 64GB 4GB RAM eMMC 5.1
MAIN CAMERA	<u>Single</u>	8 MP, AF
	<u>Video</u>	1080p@30fps
SELFIE CAMERA	<u>Single</u>	2 MP
	<u>Video</u>	
SOUND	<u>Loudspeaker</u>	Yes, with stereo speakers
	<u>3.5mm jack</u>	Yes
COMMS	<u>WLAN</u>	Wi-Fi 802.11 a/b/g/n/ac, dual-band, Wi-Fi Direct, hotspot
	<u>Bluetooth</u>	5.0, A2DP, LE
	<u>GPS</u>	Yes, with A-GPS, GLONASS, BDS, GALILEO
	<u>NFC</u>	No
	<u>Radio</u>	No
	<u>USB</u>	USB Type-C 2.0
FEATURES	<u>Sensors</u>	Accelerometer, compass
BATTERY	<u>Type</u>	Li-Po 5100 mAh, non-removable
	<u>Charging</u>	Fast charging 15W

BOHA!™ WORK STATION

The most powerful, flexible back-of-house tool.

The base of your BOHA! Work Station is a print station like no other. Best-in-class printer mechs let you print date-code, nutrition, grab 'n go, prep, Use By, even dual-column labels, all through the BOHA! Labeling app.



*iPad sold separately



Mobile WiFi Printing

Print labels from anywhere with a connected tablet via BOHA! Link's WiFi network AND fast. Labels print quickly at 5 inches per second.



Label Flexibility

Print 1", 2" or 3" wide labels with drop-in paper loading convenience.



Crisper, Cleaner Printing

Industry leading 300dpi ensures your labels are easy-to-read and FDA compliant.

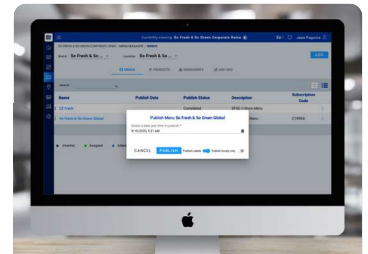

Centralized Menu Management

Centrally manage your menu information from BOHA! Control Center and send Cloud Based updates.

SPECIFICATIONS

Print Mechanisms	2	Communications	WiFi 802.11 b/g/n/ac, 2.4/5 GHz Bluetooth 4.2 Bluetooth Low Energy (BLE)
Print Resolution	300 dpi (11.8 dot.mm)	Ethernet	Ethernet (Max throughput 300 Mbps)
Max Print Zone	2.87" (73mm)	USB Charging Connections	2 - USB Type A, 1 - USB Type C
Print Speed	5 ips (127mm/sec)	USB Data Ports	3 USB 2.0 High Speed Ports
Print Head Life	50 km	Program Storage	SD Card – 32 GB
Paper Path	Open	Power Supply	Internal, 110-240 VAC, 50/60Hz
Label Types	Direct Thermal, Die Cut Direct Thermal, Continuous w/Liner	Dimensions	10.8"W x 10.0"D x 9.3"H
Label Position Detection	Gap sensing	Weight	5 lbs
Maximum Label Roll Diameter	4.5" (114.3mm)	Operating Temperature	5-50°C, 10-90% RH
Maximum Label Length	22" (560mm)	Compliance	TUV, FCC, IC, CE, RED, ROHS 3
Label Width	1" - 3" wide, fully adjustable	Warranty	1 Year Standard Warranty

Product Specifications

Product Name	Rice Mat Maker for Commercial Use
Machine Name	MAK I MAKER
Model Name	ASM865A
Power Source	AC 120V, 60Hz
Power Consumption	115W, 1A
External Dimensions	W 13.7in. x D 16.9 in. (max 23.0 in.) x H 23.2 in. (W 348 mm x D 430 mm (max585mm) x H 590 mm) * Excluding the Power Cord and salient of the Screws.
Weight	70.5 lbs. (32 kg.)
Rice Mat Forming Size	
Rice Mat Width	7.4 in.(185mm) (vertical roll forming unit)/8.2 in.(205mm) (horizontal roll forming unit)
Rice Mat Length	1.2 in. ~ 8.6 in. (30 mm to 215 mm)
Rice Mat Thickness	0.2 in. ~ 0.6 in. (5 mm to 15 mm)
Rice Amount Adjustable Range	1.4 oz. ~ 14.0 oz. (40 to 400 g)
Seaweed Size Available	7.4in. x 4.2 in. ~ 8.4 in. (185mm x 105 mm to 210 mm)
Forming Capacity (Continuous Supply Operation)	
Cycle time	3.0 to 4.0 seconds
Forming capacity per hour	900 to 1200 mats per hour
Hopper Capacity (Rice Amount)	Maximum: Approx. 18.1 lbs. (8.2 kg)
Rice Supply	Automatic stirring supply (beltless) method
Rice Mat Thickness Adjustment Method	Motor drive method (Automatic setting)
Optional Functions	Heater function: equipped with a heater at the back of the Rice Guide Auto supply function: equipped with a function to automatically start operation after the rice mat is removed
Accessories	Pick Plate x 2
Optional Parts	Extension switch & extension cable (The switch can be used as a foot switch when connected to the extension cable.)
Fuse Capacity	2 amperes (A)
Power Cord	Grounding type Plug (9.8 ft. (3m) Cord) Inlet plug-in type

External Diagrams

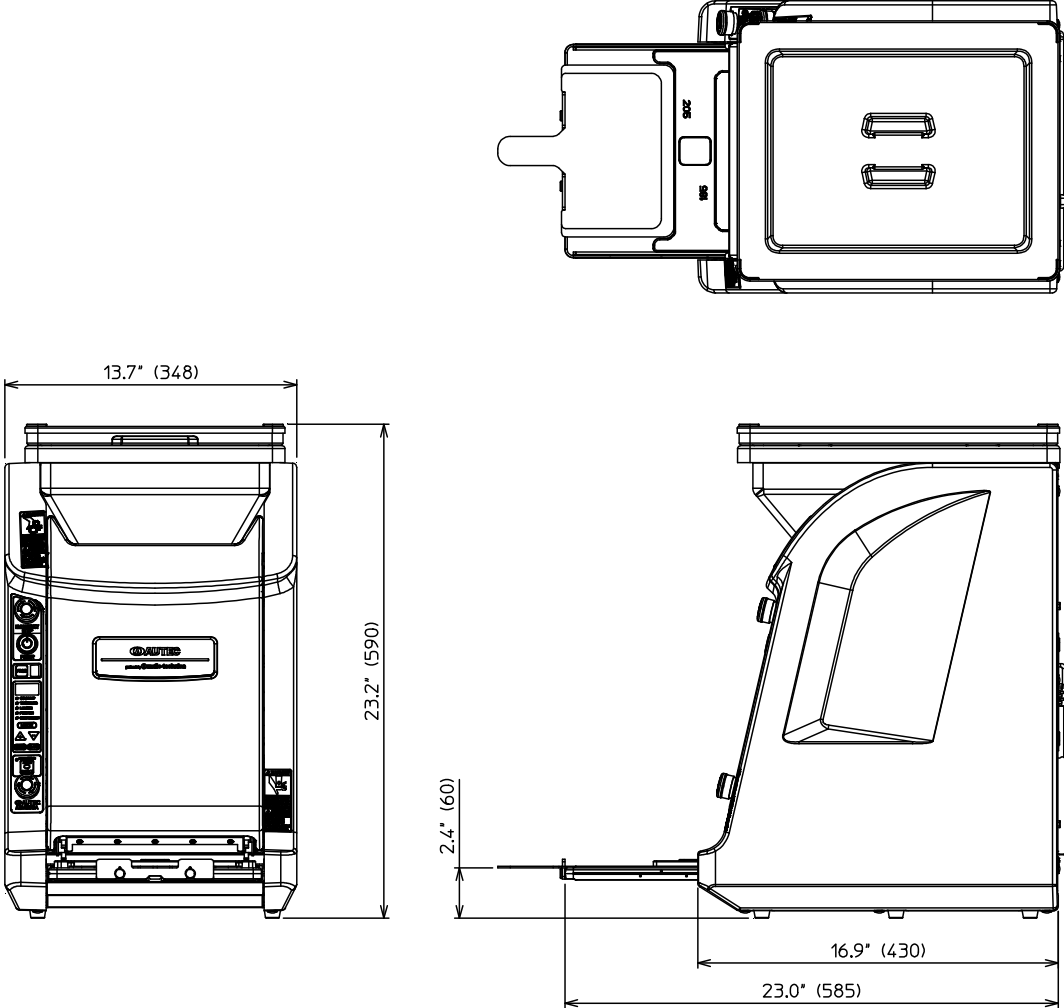

- Specifications and design of the machine are liable to change without prior notice for purposes of improvement.

Specifications

General Specifications

Name	Rice Sheet MACHINE	
Model	SVR-NYA-EH	
Dimensions	W360 X D550 X H640 mm	
Weight	Approx. 36 kg or less (reference value)	
Power Supply	AC 110V - 120V	
Power Consumption	70W	
Rated Frequency	50/60Hz	
Power Cord	A UL/CSA approved power supply cord set shall be used. Type STO, 60 C, VW-1, 3Cx16AWG, rated 300V, 2 mm finished length min, with molded-on attachment plug NEMA5-15p.	
Hopper Capacity	7.5kg (Approximately 2.5 "shou" ^{*3)})	
Number of Roll Sizes	6 Settable Patterns	
Rice Amount ^{*1}	Thin Roll	Approx. 80g
	Medium Roll	Approx. 140g
	Thick Roll	Approx. 285g
Performance ^{*2}	Thin Roll	Approx. 950 rolls/hour
	Medium Roll	Approx. 850 rolls/hour
	Thick Roll	Approx. 750 rolls/hour

Operation Environment (items prepared by the customer)	Installation Site	Indoors
	Condition of Installation	On a flat counter or table, where the top surface is not slippery.
	Ambient Air Temperature	Between 5°C and 35°C Under the condition of no dew condensations on any point of the machine surface.
	Relative Humidity	Between 30% and 85%
	Atmosphere Environment	No dust No corrosive gas

*1 The default value is adjustable. The value depends on the settings of length, thickness, and density of rice.

*2 Handling time of filling, 3 seconds for each roll, is included.

*3 “shou” is a Japanese measurement unit for the amount of dried rice. The weight of cooked rice is to be about 3 kg for 1 “shou”. 7.5kg of sushi rice corresponds to 12.5L (liters).

Note!

- Place the machine on a flat surface. If the machine is placed on an inclined plane, it cannot work enough as shown in Specifications.

Next Generation Rice Sheet Making Machine

SVS-FCA



High Performance & User Friendly



High Quality!

Suzumo original technology enables you to get excellent quality

High Productivity!

1,250 rice sheets per hour
*Double sheets supply mode

High Capacity!

Max. 10kg of cooked rice

Easy Set Up!

17% smaller than conventional model

Easy Operation!

Only a few steps to make rice sheet

Easy Maintenance!

5% fewer parts than conventional model

How to make



1 Get rice sheet



2 Roll it

Option

Pick-up Plate

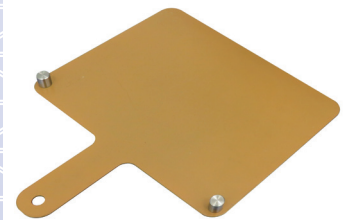

Menu



Small Roll



Large Roll



Uramaki Roll



Hand Roll

Dimensions

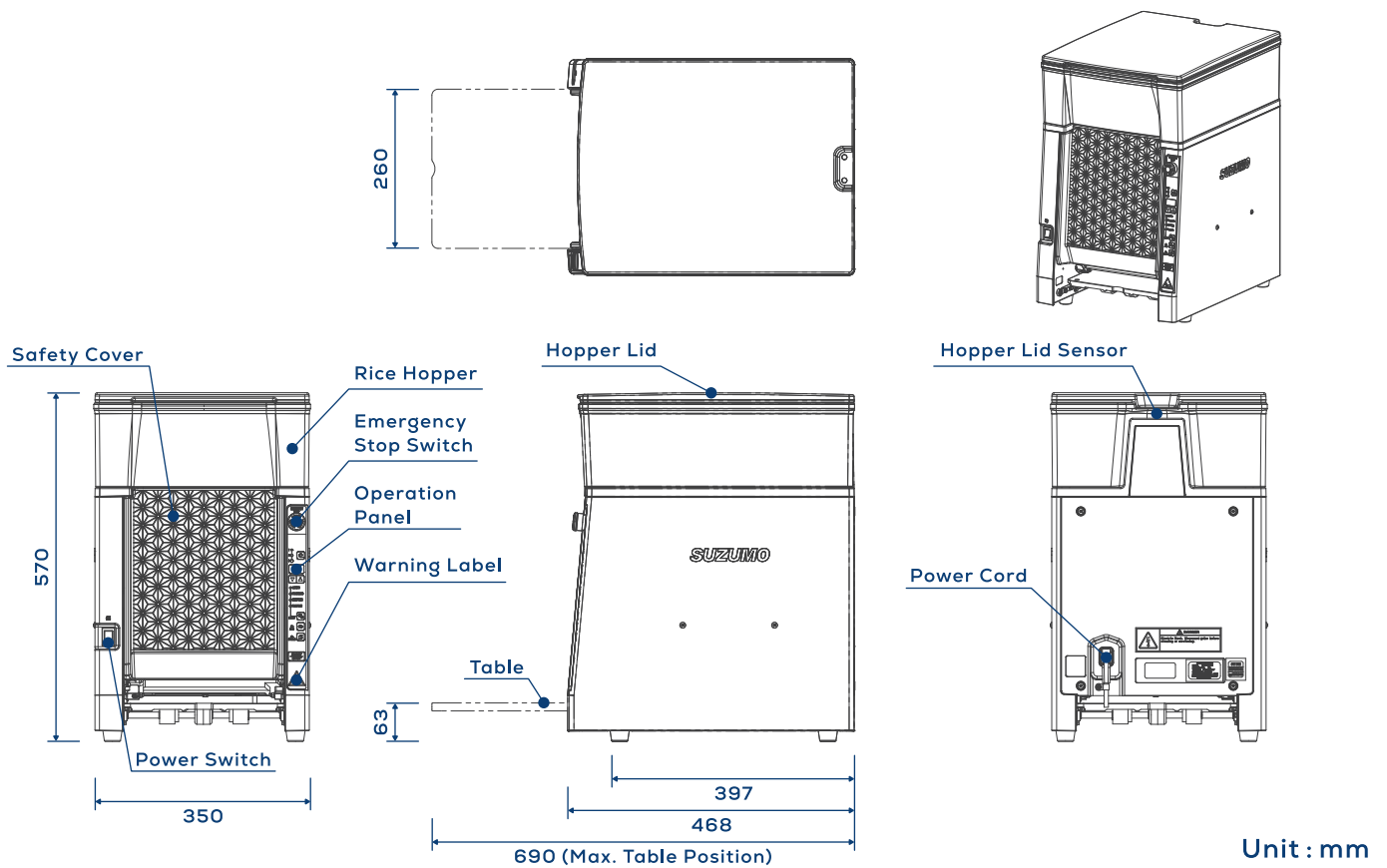

Specifications

Model	SVS-FCA-EH (UL/NSF standards certified) SVS-FCA (CE & UKCA certification declared)
Input	AC110-120V (SVS-FCA-EH) AC220-240V (SVS-FCA) 50/60Hz
Power Rating	100W (SVS-FCA-EH) 110VA (SVS-FCA)
Capacity	Small roll: 1,250 sheets / hr (Thickness 7mm, Length 80mm, Double Mode) Medium roll: 1,000 sheets / hr (Thickness 8mm, Length 110mm, Double Mode) Large roll: 750 sheets / hr (Thickness 12mm, Length 160mm)

Hopper Capacity	Approx. 10kg of cooked rice
Weight	31kg
Dimensions	350W×468D×570Hmm (Table closed) 350W×690D×570Hmm (Max. table position)
Rice Amount	Approx. 70-300g
Power Cable	Approx. 2m
Functions	Double sheets supply mode Automatic supply mode 3 sizes can be memorized

*Designs and specifications are subject to change without notice.

*While capacity expresses the machine's performance capabilities, it is predicated upon the machine being operated correctly.

Contact Us

Suzumo Machinery Co., Ltd.

Global Business Division

Tel. +81 3-3993-1407

e-mail overseas@suzumo.co.jp

Contact in North America

Suzumo International Corporation

Head Office (CA) : Tel. +1 310-328-0400

East Office (NJ) : Tel. +1 201-568-1900

e-mail sic@suzumokikou.com

Visit Our Website

<https://www.suzumokikou.com>



Contact in Singapore

Suzumo Singapore Corporation Pte. Ltd.

Tel. +65 6254-2080

e-mail sales@suzumo-sg.com

EFFECTIVE DATES

State Effective Dates

The following states have franchise laws that require that the Franchise Disclosure Document be registered or filed with the state, or be exempt from registration: California, Hawaii, Illinois, Indiana, Maryland, Michigan, Minnesota, New York, North Dakota, Rhode Island, South Dakota, Virginia, Washington, and Wisconsin.

This document is effective and may be used in the following states, where the document is filed, registered or exempt from registration, as of the Effective Date stated below:

State	Effective Date
California	Exempt
Hawaii	September 15, 2025, amended November 3, 2025, and
Illinois	Exempt
Indiana	July 30, 2025, amended September 10, 2025, September 30, 2025, and
Maryland	Exempt
Michigan	July 31, 2025
Minnesota	September 9, 2025 amended October 15, 2025, and
New York	Exempt
North Dakota	July 28, 2025, amended September 9, 2025, September 30, 2025, and
Rhode Island	August 1, 2025, amended September 11, 2025, October 1, 2025, and
South Dakota	July 28, 2025, amended
Virginia	Exempt
Washington	August 14, 2025, amended September 22, 2025, October 15, 2025, and
Wisconsin	July 28, 2025, amended September 15, 2025, September 30, 2025, and

Other states may require registration, filing, or exemption of a franchise under other laws, such as those that regulate the offer and sale of business opportunities or seller-assisted marketing plans.

EXHIBIT R

RECEIPTS

RECEIPT
(Franchisee's Copy)

This disclosure document summarizes provisions of the franchise agreement and other information in plain language. Read this disclosure document and all agreements carefully.

If AFC offers you a franchise, AFC must provide this disclosure document to you 14 calendar-days before you sign a binding agreement with, or make a payment to, the franchisor or an affiliate in connection with the proposed franchise sale.

New York requires that we give you this disclosure document at the earlier of the first personal meeting or 10 business days before the execution of the franchise or other agreement or the payment of any consideration that relates to the franchise relationship. Michigan requires that we give you this disclosure document at least 10 business days before the execution of any binding franchise or other agreement or the payment of any consideration that relates to the franchise relationship, whichever occurs first.

If AFC does not deliver this disclosure document on time or if it contains a false or misleading statement, or a material omission, a violation of federal and state law may have occurred and should be reported to the Federal Trade Commission, Washington D.C. 20580 and the state administrator listed in Exhibit N to the disclosure document.

The name, principal business address and phone number of each franchise seller offering the franchise is:

Franchisor:

Advanced Fresh Concepts Franchise Corp.
19700 Mariner Avenue
Torrance, California 90503
Telephone: 310-604-3200
info@afcsushi.com
www.afcsushi.com

Franchise Seller:

Name of Individual(s) selling on behalf of Franchisor:

Advanced Fresh Concepts Franchise Corp.
19700 Mariner Avenue
Torrance, California 90503
Telephone: 310-604-3200

Issuance Date: July 22, 2025, amended August 28, 2025, September 23, 2025, and May 7, 2026.

We authorize Incorp Services, Inc. 5716 Corsa Avenue, Suite 110, Westlake Village, California 91362-7354 to receive service of process for us or see Exhibit N if you are located outside California.

I received a Disclosure Document dated July 22, 2025, amended August 28, 2025, September 23, 2025, and May 7, 2026, that included the following Exhibits:

A.	Financial Statements	J.	Food Service Counter Transfer Agreement
B.	Franchise Application	K.	Promissory Note
C.	Franchise Agreement	L.	Table of Contents of Manuals
D.	Full-Time Location Franchise Addendum	M.	List of Franchisees, Company Owned Locations, Transfers, Terminations, Non-Renewals, Ceased Operations/Other in our Last Fiscal Year
E.	Part-Time Location Franchise Addendum	N.	List of State Administrators and Agents for Service of Process
F.	Self-Service Location Addendum	O.	State Specific Addenda
G.	General Release	P.	Confidentiality Agreement
H.	Assignment of Franchise Agreement and Franchisor Consent	Q.	Tablet and Rice Sheeter Specifications
I.	Asset Sale and Purchase Agreement	R.	Receipts

Date: _____

PROSPECTIVE FRANCHISEE'S SIGNATURE

(Print Name)

Keep This Copy for Your Records.

**RECEIPT
(Franchisor's Copy)**

This disclosure document summarizes provisions of the franchise agreement and other information in plain language. Read this disclosure document and all agreements carefully.

If AFC offers you a franchise, AFC must provide this disclosure document to you 14 calendar-days before you sign a binding agreement with, or make a payment to, the franchisor or an affiliate in connection with the proposed franchise sale.

New York requires that we give you this disclosure document at the earlier of the first personal meeting or 10 business days before the execution of the franchise or other agreement or the payment of any consideration that relates to the franchise relationship. Michigan requires that we give you this disclosure document at least 10 business days before the execution of any binding franchise or other agreement or the payment of any consideration that relates to the franchise relationship, whichever occurs first.

If AFC does not deliver this disclosure document on time or if it contains a false or misleading statement, or a material omission, a violation of federal and state law may have occurred and should be reported to the Federal Trade Commission, Washington D.C. 20580 and the state administrator listed in Exhibit N to the disclosure document.

The name, principal business address and phone number of each franchise seller offering the franchise is:

Franchisor:

Advanced Fresh Concepts Franchise Corp.
19700 Mariner Avenue
Torrance, California 90503
Telephone: 310-604-3200
info@afcsushi.com
www.afcsushi.com

Franchise Seller:

Name of Individual(s) selling on behalf of Franchisor:

Advanced Fresh Concepts Franchise Corp.
19700 Mariner Avenue
Torrance, California 90503
Telephone: 310-604-3200

Issuance Date: July 22, 2025, amended August 28, 2025, September 23, 2025, and May 7, 2026.

We authorize Incorp Services, Inc. 5716 Corsa Avenue, Suite 110, Westlake Village, California 91362-7354 to receive service of process for us or see Exhibit N if you are located outside California.

I received a Disclosure Document dated July 22, 2025, amended August 28, 2025, September 23, 2025, and May 7, 2026, that included the following Exhibits:

A.	Financial Statements	J.	Food Service Counter Transfer Agreement
B.	Franchise Application	K.	Promissory Note
C.	Franchise Agreement	L.	Table of Contents of Manuals
D.	Full-Time Location Franchise Addendum	M.	List of Franchisees, Company Owned Locations, Transfers, Terminations, Non-Renewals, Ceased Operations/Other in our Last Fiscal Year
E.	Part-Time Location Franchise Addendum	N.	List of State Administrators and Agents for Service of Process
F.	Self-Service Location Addendum	O.	State Specific Addenda
G.	General Release	P.	Confidentiality Agreement
H.	Assignment of Franchise Agreement and Franchisor Consent	Q.	Tablet and Rice Sheeter Specifications
I.	Asset Sale and Purchase Agreement	R.	Receipts

Date: _____

PROSPECTIVE FRANCHISEE'S SIGNATURE

(Print Name)

Return this copy to us.